

MODEL USER GUIDE

Model



Release 25.3
Last Updated: 21 April 2025

Information in this document is subject to change without notice. Companies, names and data used in examples are fictitious.

Copyright ©2025 by InEight. All rights reserved. No part of this document may be reproduced or transmitted in any form or by any means, electronic or mechanical, for any purpose, without the express permission of InEight.

Microsoft Windows, Internet Explorer and Microsoft Excel are registered trademarks of Microsoft Corporation.

Although InEight Model has undergone extensive testing, InEight makes no warranty or representation, either express or implied, with respect to this software or documentation, its quality, performance, merchantability, or fitness for purpose. As a result, this software and documentation are licensed “as is”, and you, the licensee are assuming the entire risk as to its quality and performance. In no event will InEight be liable for direct, indirect, special, incidental or consequential damages arising out of the use or inability to use the software or documentation.

Release 25.3
Last Updated: 21 April 2025

This page intentionally left blank.

CONTENTS

- 0.1 InEight Model Overview 25
 - 0.1.1 Easily Share Models and Information 25
- CHAPTER 0 – ADMINISTRATION 25**
 - 0.1 Roles and permissions 25
 - 0.2 Manage users 27
 - Create a new user 27
 - 0.3 Enable projects for Model 30
 - Enable Model in Product integrations 31
- CHAPTER 1 – ADMIN TOOLS - MODEL (LEGACY) 37**
 - 1.1 Introduction 37
 - 1.1.1 Browser compatibility 37
 - 1.2 Login 38
 - 1.2.1 Log-in Options 39
 - 1.2.1.1 Username and Password Credentials 39
 - Reset password 39
 - 1.2.1.2 SSO by Microsoft 40
 - 1.2.1.3 SSO by Google 41
 - 1.2.2 Switch account 41
 - 1.3 Slide-out Panel 42
 - 1.4 Projects 43
 - 1.5 User Access Overview 45
 - 1.6 User Account Management 46
 - 1.6.1 Users & groups tab 47
 - 1.6.1.1 Users 47
 - 1.6.1.2 Create single sign-on or password user 48
 - Add user 49

1.6 Step by Step 1 – Add user	49
Edit user	50
1.6 Step by Step 2 – Edit user	50
Activate user	51
Deactivate user	51
Reset a user's password (SSO off)	51
Set a user's temporary password (SSO off)	51
Delete a pending user	51
Resend activation email (SSO off)	51
1.6.1.3 Groups	52
Add a group	52
Delete a group	52
Rename a group	52
1.6.2 Project permissions tab	52
1.6.3 Export	54
CHAPTER 1 – INSTALLATION	55
1.1 Installation	56
1.1.1 Model (Integrated with Platform)	56
Install InEight Model Integrated with Platform	56
1.1.1.1 Considerations	63
1.1.2 Model (Legacy)	64
Install the InEight Model desktop application	64
1.2 Plug-ins	64
1.3 Launch Model	65
1.3.1 Launch Model (Integrated with Platform)	65
Launch Model (integrated with Platform)	65
1.3.1.1 Considerations	68
1.3.2 Launch Model (Legacy)	68
Launch Model (not integrated with Platform)	68
1.3.2.2 Considerations	68
1.4 Model cache	68
1.4.1 Move cache to a new location	69
1.4.2 Considerations	70
1.4.3 Steps	70
Moving your existing InEightModel_Cache folder	70
Lesson 1 Review	71
Lesson 1 Summary	71

CHAPTER 2 – PROJECTS	73
2.1 Create a project	74
Create a project integrated with InEight Platform	74
Create a project not integrated with InEight Platform	74
2.2 Enable projects for Model	75
Enable Model in Product integrations	76
2.3 Load a project	81
2.3 Step by Step 1 – Load a Project	82
2.3.1 Manage sync	83
2.3.2 Remove projects from cache	84
2.4 Create a new project from template	85
2.4.1 Considerations	86
2.4.2 Steps	87
Create a New Project from Template	87
Lesson 2 Review	88
 CHAPTER 3 – MODEL STREAMS	 91
3.1 Model streams overview	91
3.2 Config Settings	92
3.2.0.1 Overview - Configuring Model Streams Parameters tab	97
3.2 Step by Step 1 – Config Settings - Parameters	98
3.2 Step by Step 2 – Config Settings - Scale / Rotate / XYZ	102
3.2 Step by Step 3 – Config Settings - Rename Model Stream	103
3.2 Step by Step 4 – Config Settings - Link to a different Model Stream ...	106
3.3 Export Settings	110
3.3.0.1 Export Settings options:	111
3.3.1 Steps	112
Export Settings	112
3.4 Model Revisions	113
3.4.0.1 Model with Same Name	113
3.4.0.2 Model with a Revised Name	114
3.4 Step by Step 1 – Resolve Model Conflict	115
3.5 Analyze Model Changes	117
3.5 Step by Step 1 – Analyze Model Changes	119
3.6 Point cloud	122
3.7 Point cloud data	123
3.7.1 Using point cloud	123
3.7.2 Considerations	125

CHAPTER 4 – PROJECT STRUCTURE	127
4.1 Project Structure Overview	128
4.1.1 Project Structure Panel	128
4.2 Organize Model Streams	130
4.2 Step by Step 1 – Create Groups	130
4.2 Step by Step 2 – Delete Groups	134
4.2 Step by Step 3 – Creating a Model Stream Placeholder	136
4.3 Model Stream Management	138
4.3 Step by Step 1 – Change the Active Model Stream Revision	138
4.3 Step by Step 2 – Update Model Stream Revisions	141
4.3 Step by Step 3 – Disable Model Streams	141
4.3 Step by Step 4 – Remove Model Streams	142
4.3 Step by Step 5 – Adding Model Streams from Other Projects	144
4.3 Step by Step 6 – Publish a Model Stream into a Placeholder	146
4.4 Model Stream Permissions	153
4.4 Step by Step 1 – Apply Permissions to Groups	154
Lesson 4 Review	157
Lesson 4 Summary	157
CHAPTER 5 – USER INTERFACE	159
5.1 Viewer Interface	160
5.1.1 Docking Panels:	161
5.2 Show Model Spots	165
5.2 Step by Step 1 – Show Model Spots	166
5.3 Navigation	167
5.3.0.1 First Person Navigation	170
5.4 Selection	171
5.4.0.1 Right Click Menu	178
5.5 Selection Mode	181
5.5.1 Selection Mode Indicator	182
5.5.2 Selection Mode - Last Object	182
5.5.3 Selection Mode - First Object	183
5.5.4 Selection Mode - IWP	184
5.5.5 Selection Mode - CWP	185
5.5.6 Selection Mode - Element	186
5.5.7 Selection Mode - Tag	187
5.6 Hot Keys	188
5.7 User Settings	198
5.7.1 Settings...	199

5.7.2 Mouse / Keyboard Mapping	200
5.7.3 Choose Default Zoom Behavior	201
5.7.4 Coordinate Display Units	202
5.7.5 Background Color	203
5.7.5.1 Choose Selection Display Style	204
5.7.6 Invert Scroll Wheel in First Person	204
5.8 Create New Markup	205
5.9 Grids	207
5.9 Step by Step 1 – Toggle on or off grids	208
Lesson 5 Review	209
Lesson 5 Summary	209
CHAPTER 6 – PROJECT UPDATES AND HISTORY	211
6.1 Command History	212
6.2 Project Updates	213
6.3 Project History	215
Lesson 6 Review	219
Lesson 6 Summary	219
CHAPTER 7 – TAGS AND OBJECTS	221
7.1 Tags and Objects Overview	222
7.1.1 Tags and Objects Panel	222
7.1.1.1 Objects Tab	222
7.1 Step by Step 1 – Toggle Model Streams Visibility	225
7.1.1.2 Tags Tab	225
7.2 Create and Edit Tags	227
7.2.1 Manually Create and Edit Custom Tags	227
7.2 Step by Step 1 – Creating Tags	228
7.2.2 Delete a Tag	232
7.2 Step by Step 2 – Deleting Tags	233
7.3 Create and Edit Dynamic Tags	233
7.3 Step by Step 1 – Creating Dynamic Tags	234
7.3 Step by Step 2 – Editing a Dynamic Tag	239
7.4 Assign and Remove Tags	239
7.4.1 Assigning Tags	239
7.4 Step by Step 1 – Assigning Tags	239
7.4.2 Removing Tags	241
7.4 Step by Step 2 – Removing Tags	242
7.5 Copy Metadata from Model to Excel	242
7.5 Step by Step 1 – Copy Metadata from Model to Excel	243

7.6 Tag Data Exporter	244
7.6 Step by Step 1 – Export Tag Data to CSV file	244
7.7 Import Tags from Excel	251
7.7 Step by Step 1 – Import Tags from Excel	252
7.8 Select Model Objects Via Excel	257
7.8 Step by Step 1 – Select Model Objects via Excel	258
7.9 Create Tables of External Data	259
7.9.1 Identify the model Unique ID	259
7.9 Step by Step 1 – Identify the model Unique ID	260
7.9.2 Add information to Generic Table	264
7.9 Step by Step 2 – Add information to Generic Table	264
7.9.3 Import information to Generic Table	266
7.9 Step by Step 3 – Import information to Generic Table	266
7.9.4 Refresh existing table data	267
7.9 Step by Step 4 – Refresh existing table data	268
7.9.5 Close Database Tables	268
7.9 Step by Step 5 – Close database tables	269
Lesson 7 Review	270
Lesson 7 Summary	270
CHAPTER 8 – DATA TRANSFORMATION OPERATIONS	271
8.1 Data Transformation Operations (DTO) Overview	271
8.1.1 DTO tab	272
8.1.2 Selector tab	273
8.1.3 Actions tab	274
8.2 Manage DTOs	275
8.2.1 DTO tab	275
Add a DTO Group Folder	275
Add a DTO	276
Rename a DTO	277
8.2.2 Selector tab	277
Create a rule	277
Add additional rules to filter for other metadata	280
8.2.3 Actions tab	281
Create a new tag	281
1.1 DTO Examples	283
1.2 Clean up and normalize model data	283
1.2.1 Group similar models into a tag	283
Group similar models into a tag	284

1.2.2 Convert dimensional text data into a number	286
Convert dimensional text data into a number	287
1.2.3 Convert inches to feet	291
Convert text format to number format	291
Convert piping length from inches to feet	294
1.3 Identify and add additional model data	295
1.3.1 Identify model data	296
Identify and use AG/LB Piping	296
Identify and use AG/SB	298
Add weight to steel members using length	299
Convert weight from pounds to tons	301
1.4 Concatenate model data	303
Make unique tag values for multiple objects	303
1.5 Parse model data	306
Parse system information	307
1.6 Quantify model data	310
1.6.1 Extract quantities from model	311
1.6.1.1 Quantities by Count	311
1.6.1.2 Quantities by area	313
1.6.1.3 Quantities by volume	315
1.6.1.4 Quantities by tag	317
1.6.1.5 Access quantities via Excel Plug-in	319
1.7 Validate Model Data	320
1.7.1 Validate model data is compliant	320
Validate specific model data exists	320
Validate model data for specific format	322
CHAPTER 2 – STYLES	327
2.1 Styling Overview	328
2.1.1 Launch Styling Menu	328
2.2 Create and Manage Style Sets	329
2.2 Step by Step 1 – Create a Style Set	331
2.2 Step by Step 2 – Edit a Style Set	332
2.2 Step by Step 3 – Delete a Style Set	335
2.3 Create and Edit Styles	335
2.3 Step by Step 1 – Create a New Style	336
2.3 Step by Step 2 – Edit a Style	344
2.3 Step by Step 3 – Set a Style as a Default	345
2.3 Step by Step 4 – Delete a Style	346
2.4 Apply Styles to Tags	346

2.4 Step by Step 1 – Apply a Style to a Tag	347
2.5 Assign Styles Using Excel	349
2.5 Step by Step 1 – Color Excel Cells	350
2.6 Style Legend	354
Lesson 2 Review	357
Lesson 2 Summary	357
CHAPTER 3 – MASTER PRESETS	359
3.1 Master Presets Overview	360
3.1.1 Master Preset Editor	360
3.1.2 Reset Workspace	361
3.1.3 Right Click Menu Features	362
3.2 Create and Manage Master Presets	364
3.2 Step by Step 1 – Creating a Master Preset	364
3.2.1 Master preset object visibility maximum dialog box	365
3.2 Step by Step 2 – Editing a Master Preset	367
3.2 Step by Step 3 – Editing a Master Preset - Model View	368
3.2 Step by Step 4 – Deleting a Master Preset	370
3.3 Organize Master Presets	370
3.3 Step by Step 1 – Grouping Master Presets	371
3.3 Step by Step 2 – Set a Master Preset as the Project Default	373
3.4 Share and Export Master Presets	374
3.4 Step by Step 1 – Sharing a Master Preset	375
3.4 Step by Step 2 – Exporting Master Presets	376
Lesson 3 Review	377
Lesson 3 Summary	377
CHAPTER 4 – COORDINATION - CLASH MANAGER	379
4.1 Clash Manager Overview	380
4.2 Create and Manage Coordination Rules	381
4.2.1 Considerations	381
4.2.2 Steps	382
Create a coordination rule	382
Edit a coordination rule	384
Export rules	386
Import rules	386
4.3 Tolerance Settings	387
4.3.1 Steps	388
Create rules for Expand, Sphere, and Cylinder tolerance settings	388

4.4 Create and Interrogate Clash Results	391
4.4.1 Considerations	391
4.4.2 Steps	392
Create clash results	392
4.5 Create and Manage Coordination Rule Groups	395
4.5.1 Considerations	395
4.5.2 Steps	395
Create a coordination rule group	396
Export rules groups	397
4.6 Show Duplicate Objects	398
4.6.0.1 Export duplicate objects	399
Lesson 4 Review	400
Lesson 4 Summary	400
CHAPTER 5 – COORDINATION - ISSUE MANAGER	401
5.1 Issue Manager Overview	402
5.2 Create and Manage Coordination Issues	403
5.2.1 Considerations	403
5.2.2 Steps	403
Add folders and sub-folders to organize issues	403
Create a non-geometric clash issue	403
Create a coordination issue from clash results	404
Add markup	406
Edit an issue	406
Import issues	407
Export issues	408
Update issues	410
Delete a coordination issue	410
5.3 Coordination Issue Reporting	410
Access Issues via Excel Plugin for Reporting	411
Lesson 5 Review	414
Lesson 5 Summary	414
CHAPTER 5 – DOCUMENT ISSUE INTEGRATION	415
5.1 Document issue integration	415
CHAPTER 6 – ARCHIVE	421
6.1 Archive Overview	422
6.1.1 Archive Library	424
6.1.1.1 Library Tab	424

6.2 Manage Documents	425
6.2 Step by Step 1 – Import Documents	425
6.2 Step by Step 2 – Download Documents	427
6.2 Step by Step 3 – Organize Documents	429
6.2 Step by Step 4 – Delete Documents or Folders	430
6.2 Step by Step 5 – Accessing Document Information	431
6.2 Step by Step 6 – Apply Permissions to Folders	432
6.2 Step by Step 7 – Search Documents	435
6.3 Create and Manage Labels	435
6.3 Step by Step 1 – Create and Apply a Label to a Document	436
6.3 Step by Step 2 – Apply an Existing Label to a Document	439
6.3 Step by Step 3 – Apply or Remove Labels within the Document Info area	441
6.3 Step by Step 4 – Filter Documents by Labels	443
6.4 Link and Manage Docs to Tags	444
6.4 Step by Step 1 – Link Documents to Tags	445
6.4 Step by Step 2 – Associate a Specific Page within a PDF document to a Tag	446
6.4 Step by Step 3 – View and/or Remove an Object Tag Link via the Document Information Window	448
6.4 Step by Step 4 – View and/or Remove a Document Link via the Selection Tab	449
Lesson 6 Review	451
Lesson 6 Summary	451
CHAPTER 7 – SELECTION INFO	453
7.1 Selection Info Overview	454
7.1.1 Selection Information Panel	454
7.1.2 General Tab	455
7.1.3 Tags Tab	455
7.1.4 Style Tab	457
7.1.5 Documents Tab	458
7.1.6 Object Properties Tab	460
7.1.7 Linked Data	461
7.1.7.1 Selection Filter	462
Lesson 7 Review	464
Lesson 7 Summary	464
CHAPTER 8 – SECTIONING	465
8.1 Sectioning Overview	466

8.1.1 Sectioning Panel	466
8.1.2 Sectioning Icon	467
8.2 Create and Apply Sectioning	468
8.2 Step by Step 1 – Apply Sectioning Using the Set Box	468
8.2 Step by Step 2 – Apply Sectioning by Dragging and Dropping a Tag	470
8.2 Step by Step 3 – Apply Sectioning by the Offset	471
8.2 Step by Step 4 – Move Sectioning Panes with Grips	472
8.2 Step by Step 5 – Reset the Sectioning Box to Model Boundary	473
8.2 Step by Step 6 – Use Sectioning with Master Presets	474
Lesson 8 Review	475
Lesson 8 Summary	475
CHAPTER 9 – MEASUREMENTS	477
9.1 Measurements Overview	478
9.1.1 Measurement window	478
9.2 Apply and Manage Measurements	480
9.2 Step by Step 1 – Enter Measurement Mode	481
9.2 Step by Step 2 – Take a Measurement	481
9.2 Step by Step 3 – Delete a Measurement	485
9.2 Step by Step 4 – Clear Measurements	485
9.2 Step by Step 5 – Organize Measurements	486
Lesson 9 Review	490
Lesson 9 Summary	490
CHAPTER 10 – MODEL EXPORTS	491
10.1 IFC Export	491
10.1 Step by Step 1 – IFC Export	492
10.2 OBJ Export	493
10.2 Step by Step 1 – OBJ Export	494
CHAPTER 11 – MODEL-BASED TAKEOFF	497
11.1 Model-Estimate overview	497
11.2 Model and Estimate integration using the Model Connector	498
11.2.0.1 Summing quantities using a parent cost item	501
11.2.1 Considerations	502
11.2.2 Steps	502
Send selected CBS structure to Model’s DTO panel	502
Run Model DTOs	503
Sync Model quantities	505
Select and frame Model objects	505

11.3 User-Defined Fields	506
11.3.1 Steps	507
Rule setup using User Defined 12 and 13 fields	508
Rule setup using User Defined 12-15 fields	510
Rule setup using User Defined 11 field	511
CHAPTER 12 – ELEMENTS	513
12.1 Elements Overview	514
12.1.1 Elements Panel	514
12.2 Manually created elements	516
12.2 Step by Step 1 – Create an element	517
12.2 Step by Step 2 – Create elements from a selection of objects	522
12.2 Step by Step 3 – Create elements from the tags	525
12.2 Step by Step 4 – Edit an element	526
12.2 Step by Step 5 – Unlink objects from an element	527
12.2 Step by Step 6 – Delete an element	527
12.3 Automation of element creation - Activity components	528
12.3.1 Steps	528
Create Elements and Activity Components using DTOs	528
12.3.1.1 Using ClaimingScheme Id for Field Name	530
12.3.1.2 Using Description for Field Name	530
12.3.1.3 Using Discipline Id for Field Name	530
12.3.1.4 Using Quantity for Field Name	531
12.3.1.5 Using UoM for Field Name	531
12.3.1.6 Using WBS Id for Field Name	531
12.3.2 Considerations	533
12.4 Automation of element creation - Material components	533
12.4.1 Steps	533
Create Elements and material Components using DTOs	533
12.4.2 Considerations	536
12.5 Automation of element creation - Aggregate components	536
12.5.1 Steps	537
Create Elements and aggregate Components using DTOs	537
12.5.2 Considerations	539
12.6 Quantity claiming	540
12.6.1 Steps	540
12.6.2 Considerations	541
Lesson 12 Review	542
Lesson 12 Summary	542

CHAPTER 13 – ADVANCED WORK PACKAGING & WORKFACE	
PLANNING	543
13.1 Work Packaging Overview	543
13.1.1 AWP Panel	544
13.2 Creating & Managing CWA, CWP & IWP	546
13.2 Step by Step 1 – Create a Construction Work Area (CWA)	547
13.2 Step by Step 2 – Create a Construction Work Package (CWP)	549
13.2 Step by Step 3 – Create a Installatoin Work Package (IWP)	552
13.2 Step by Step 4 – Deleting AWP Structure	554
13.2 Step by Step 5 – Filter AWP Structure	555
13.3 Quantity claiming	555
13.3.1 Steps	556
13.3.2 Considerations	557
CHAPTER 13 – SCHEDULE	557
13.1 InEight Visual Report	557
CHAPTER 14 – MODEL MOBILE	561
14.1 Introduction	561
14.2 Overview	561
14.2.1 Considerations	584
CHAPTER 14 – TAGS AND OBJECTS	584
14.1 Tags and objects overview	584
14.2 Manage tags	584
14.2.1 Steps	584
Add new tags	584
Add and update tag values	585
Remove tag values	586
14.3 Styles	586
14.4 Style Sets	586
CHAPTER 14 – MEASUREMENTS	590
14.1 Measurements	590
14.1.1 Steps	596
Perform a measurement	596
14.2 Elements	596
14.3 Quantity claiming	596
14.3.1 Steps	598
14.3.2 Considerations	599
14.4 Advanced work packaging & workface planning	600

14.5 Quantity claiming 600
 14.5.1 Considerations 606
14.6 Model frequently asked questions 606

STEP-BY-STEP PROCEDURES

Create a new user	27
Enable Model in Product integrations	31
1.6 Step by Step 1 – Add user	49
1.6 Step by Step 2 – Edit user	50
Install InEight Model Integrated with Platform	56
Install the InEight Model desktop application	64
Launch Model (integrated with Platform)	65
Launch Model (not integrated with Platform)	68
Moving your existing InEightModel_Cache folder	70
Create a project integrated with InEight Platform	74
Create a project not integrated with InEight Platform	74
Enable Model in Product integrations	76
2.3 Step by Step 1 – Load a Project	82
Create a New Project from Template	87
3.2 Step by Step 1 – Config Settings - Parameters	98
3.2 Step by Step 2 – Config Settings - Scale / Rotate / XYZ	102
3.2 Step by Step 3 – Config Settings - Rename Model Stream	103
3.2 Step by Step 4 – Config Settings - Link to a different Model Stream	106
Export Settings	112
3.4 Step by Step 1 – Resolve Model Conflict	115
3.5 Step by Step 1 – Analyze Model Changes	119
4.2 Step by Step 1 – Create Groups	130
4.2 Step by Step 2 – Delete Groups	134
4.2 Step by Step 3 – Creating a Model Stream Placeholder	136
4.3 Step by Step 1 – Change the Active Model Stream Revision	138
4.3 Step by Step 2 – Update Model Stream Revisions	141
4.3 Step by Step 3 – Disable Model Streams	141
4.3 Step by Step 4 – Remove Model Streams	142

4.3 Step by Step 5 – Adding Model Streams from Other Projects	144
4.3 Step by Step 6 – Publish a Model Stream into a Placeholder	146
4.4 Step by Step 1 – Apply Permissions to Groups	154
5.2 Step by Step 1 – Show Model Spots	166
5.9 Step by Step 1 – Toggle on or off grids	208
7.1 Step by Step 1 – Toggle Model Streams Visibility	225
7.2 Step by Step 1 – Creating Tags	228
7.2 Step by Step 2 – Deleting Tags	233
7.3 Step by Step 1 – Creating Dynamic Tags	234
7.3 Step by Step 2 – Editing a Dynamic Tag	239
7.4 Step by Step 1 – Assigning Tags	239
7.4 Step by Step 2 – Removing Tags	242
7.5 Step by Step 1 – Copy Metadata from Model to Excel	243
7.6 Step by Step 1 – Export Tag Data to CSV file	244
7.7 Step by Step 1 – Import Tags from Excel	252
7.8 Step by Step 1 – Select Model Objects via Excel	258
7.9 Step by Step 1 – Identify the model Unique ID	260
7.9 Step by Step 2 – Add information to Generic Table	264
7.9 Step by Step 3 – Import information to Generic Table	266
7.9 Step by Step 4 – Refresh existing table data	268
7.9 Step by Step 5 – Close database tables	269
Add a DTO Group Folder	275
Add a DTO	276
Rename a DTO	277
Create a rule	277
Add additional rules to filter for other metadata	280
Create a new tag	281
Group similar models into a tag	284
Convert dimensional text data into a number	287
Convert text format to number format	291

Convert piping length from inches to feet	294
Identify and use AG/LB Piping	296
Identify and use AG/SB	298
Add weight to steel members using length	299
Convert weight from pounds to tons	301
Make unique tag values for multiple objects	303
Parse system information	307
Validate specific model data exists	320
Validate model data for specific format	322
2.2 Step by Step 1 – Create a Style Set	331
2.2 Step by Step 2 – Edit a Style Set	332
2.2 Step by Step 3 – Delete a Style Set	335
2.3 Step by Step 1 – Create a New Style	336
2.3 Step by Step 2 – Edit a Style	344
2.3 Step by Step 3 – Set a Style as a Default	345
2.3 Step by Step 4 – Delete a Style	346
2.4 Step by Step 1 – Apply a Style to a Tag	347
2.5 Step by Step 1 – Color Excel Cells	350
3.2 Step by Step 1 – Creating a Master Preset	364
3.2 Step by Step 2 – Editing a Master Preset	367
3.2 Step by Step 3 – Editing a Master Preset - Model View	368
3.2 Step by Step 4 – Deleting a Master Preset	370
3.3 Step by Step 1 – Grouping Master Presets	371
3.3 Step by Step 2 – Set a Master Preset as the Project Default	373
3.4 Step by Step 1 – Sharing a Master Preset	375
3.4 Step by Step 2 – Exporting Master Presets	376
Create a coordination rule	382
Edit a coordination rule	384
Export rules	386
Import rules	386

Create rules for Expand, Sphere, and Cylinder tolerance settings	388
Create clash results	392
Create a coordination rule group	396
Export rules groups	397
Add folders and sub-folders to organize issues	403
Create a non-geometric clash issue	403
Create a coordination issue from clash results	404
Add markup	406
Edit an issue	406
Import issues	407
Export issues	408
Update issues	410
Delete a coordination issue	410
Access Issues via Excel Plugin for Reporting	411
6.2 Step by Step 1 – Import Documents	425
6.2 Step by Step 2 – Download Documents	427
6.2 Step by Step 3 – Organize Documents	429
6.2 Step by Step 4 – Delete Documents or Folders	430
6.2 Step by Step 5 – Accessing Document Information	431
6.2 Step by Step 6 – Apply Permissions to Folders	432
6.2 Step by Step 7 – Search Documents	435
6.3 Step by Step 1 – Create and Apply a Label to a Document	436
6.3 Step by Step 2 – Apply an Existing Label to a Document	439
6.3 Step by Step 3 – Apply or Remove Labels within the Document Info area ...	441
6.3 Step by Step 4 – Filter Documents by Labels	443
6.4 Step by Step 1 – Link Documents to Tags	445
6.4 Step by Step 2 – Associate a Specific Page within a PDF document to a Tag	446
6.4 Step by Step 3 – View and/or Remove an Object Tag Link via the Document Information Window	448

6.4 Step by Step 4 – View and/or Remove a Document Link via the Selection Tab 449

8.2 Step by Step 1 – Apply Sectioning Using the Set Box 468

8.2 Step by Step 2 – Apply Sectioning by Dragging and Dropping a Tag 470

8.2 Step by Step 3 – Apply Sectioning by the Offset 471

8.2 Step by Step 4 – Move Sectioning Panes with Grips 472

8.2 Step by Step 5 – Reset the Sectioning Box to Model Boundary 473

8.2 Step by Step 6 – Use Sectioning with Master Presets 474

9.2 Step by Step 1 – Enter Measurement Mode 481

9.2 Step by Step 2 – Take a Measurement 481

9.2 Step by Step 3 – Delete a Measurement 485

9.2 Step by Step 4 – Clear Measurements 485

9.2 Step by Step 5 – Organize Measurements 486

10.1 Step by Step 1 – IFC Export 492

10.2 Step by Step 1 – OBJ Export 494

Send selected CBS structure to Model’s DTO panel 502

Run Model DTOs 503

Sync Model quantities 505

Select and frame Model objects 505

Rule setup using User Defined 12 and 13 fields 508

Rule setup using User Defined 12-15 fields 510

Rule setup using User Defined 11 field 511

12.2 Step by Step 1 – Create an element 517

12.2 Step by Step 2 – Create elements from a selection of objects 522

12.2 Step by Step 3 – Create elements from the tags 525

12.2 Step by Step 4 – Edit an element 526

12.2 Step by Step 5 – Unlink objects from an element 527

12.2 Step by Step 6 – Delete an element 527

Create Elements and Activity Components using DTOs 528

Create Elements and material Components using DTOs 533

Create Elements and aggregate Components using DTOs	537
13.2 Step by Step 1 – Create a Construction Work Area (CWA)	547
13.2 Step by Step 2 – Create a Construction Work Package (CWP)	549
13.2 Step by Step 3 – Create a Installatoin Work Package (IWP)	552
13.2 Step by Step 4 – Deleting AWP Structure	554
13.2 Step by Step 5 – Filter AWP Structure	555
Add new tags	584
Add and update tag values	585
Remove tag values	586
Perform a measurement	596

0.1 INEIGHT MODEL OVERVIEW

InEight Model is a platform for model and information aggregation that hides the complexity of managing versions and sharing information across teams.

Import, contribute, modify, and recall models and information in a variety of ways. InEight Model supports BIM to FM, coordination, field management, design renderings, visual scheduling, sensor monitoring, and more. Collect and reuse data throughout the design, construction, and operations phases without the current limitations of: managing file types, delays in uploading and downloading files, version control, reentering data, and the difficulties of managing numerous point-solution applications.

0.1.1 EASILY SHARE MODELS AND INFORMATION

When an internet connection is available, you are able to share models, information, documents, visual styles, and much more with other users. We store your data on our servers and sync it to your local hard drive whenever you're online. Offline, your project data is kept in a central location on your computer. When you're ready share, login and sync online. As teammates sync and share, you can choose to view and interact with the information that only pertains to you

CHAPTER 0 – ADMINISTRATION

0.1 ROLES AND PERMISSIONS

You can use Model roles and permissions in InEight Platform to better manage access to Model. For example, you can create a role named Estimator with permissions to Tags and objects and Data Transformation Operations (DTO) only. For more information about roles and permissions, see [Roles and permissions](#) in Platform.

Currently, the following Model permissions are active in Platform and available to assign to roles:

Section	Description
Model	Allows an Admin to select permissions for users to access Model projects and Model mobile and to select permissions to publish model streams and manage Model projects.
Tags and objects	Allows an Admin to select permissions for users to manage tags and objects.
Data Transformation Operations (DTO)	Allows an Admin to select permissions for users to manage and run DTOs.
Coordination	Allows an Admin to select permissions for users to access the Clash and Issue Manager panels and manage clashes and issues.
Project structures	Allows an Admin to select permissions for users to view and edit project structures and edit permissions for model streams.
Excel Plug-in	Allows an Admin to select permissions for users related to the Microsoft Excel plug-in's linked data, tag import, tables, Visual Reporting, and InEight Schedule Inspector.

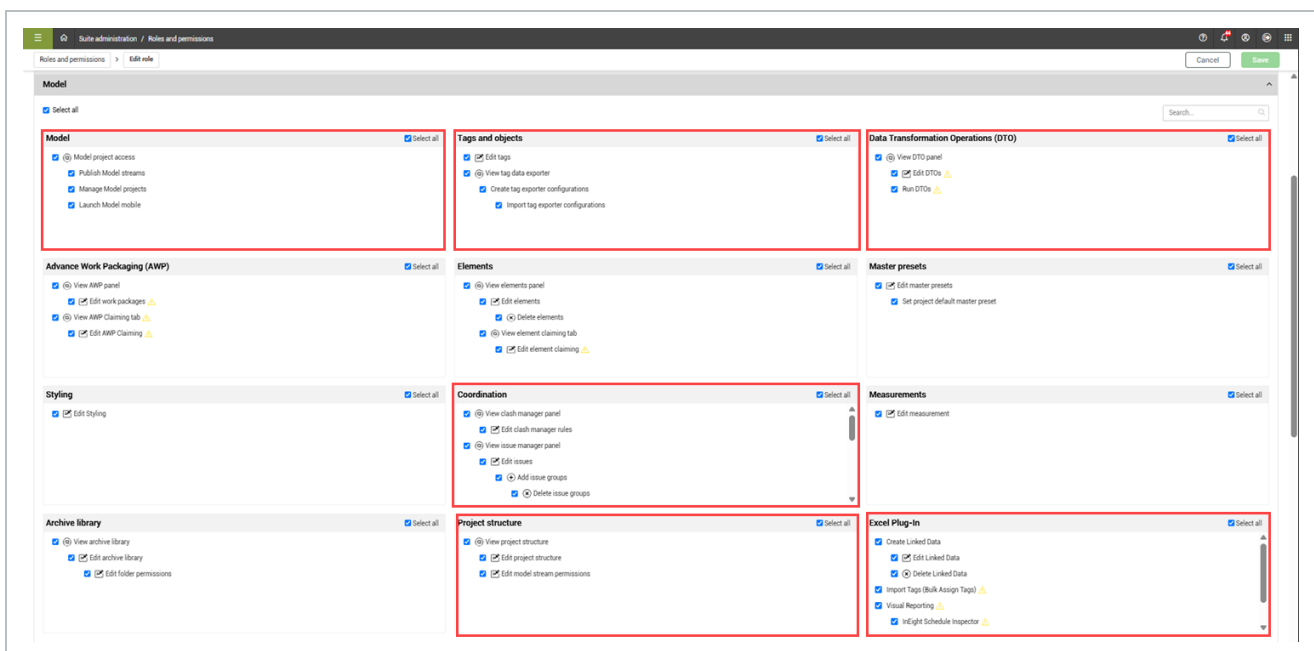

Currently, all users have access to those sections where permissions have not been activated for Model and integrated within Platform. Permissions with a yellow caution icon indicates that by selecting the permission, it also enables related permissions in other Model permission sections.

0.2 MANAGE USERS

Model integrates with Platform to manage users, roles and projects. You can assign Model role permissions depending on the user's function. The first step is to add the user to Platform.

CREATE A NEW USER

1. Go to Main menu > Suite administration > **User management**. The User management page opens.

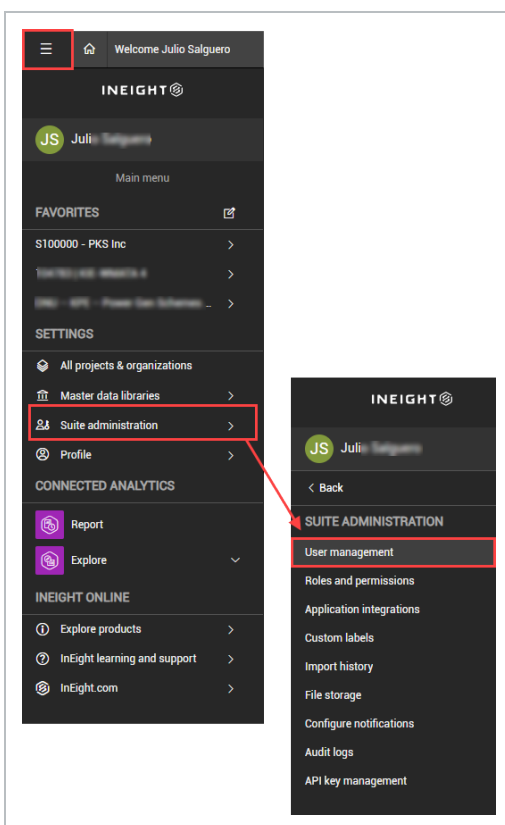

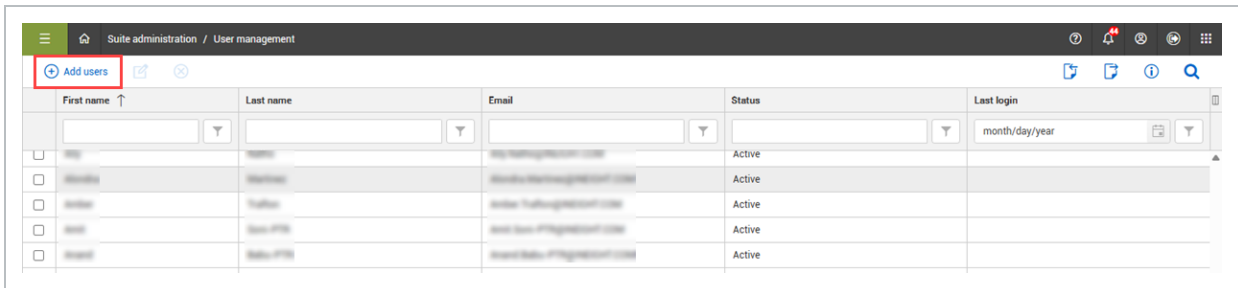

2. Click the **Add users** button. The Add users dialog box opens.





3. Enter the user details, and then click **Next**.

Add users ✕

1 DETAILS **2** ROLES

* First name <input type="text" value="John"/>	* Last name <input type="text" value="Doe"/>
* Email address <input type="text" value="jdoe@ineight.com"/>	* Start date <input style="border: 1px solid #ccc; border-radius: 4px; padding: 2px 10px;" type="text" value="4/2/2025"/> 
* End date <input style="border: 1px solid #ccc; border-radius: 4px; padding: 2px 10px;" type="text" value="4/2/2029"/> 	Vendor <input style="border: 1px solid #ccc; border-radius: 4px; padding: 2px 10px;" type="text"/> <small>Hint: type vendor name or ID</small>

Contact

Office number <input type="text" value="6025551212"/>	Mobile number <input type="text" value="6021115252"/>
Country / Region <input style="border: 1px solid #ccc; border-radius: 4px; padding: 2px 10px;" type="text" value="United States Of America"/> 	Address 1 <input type="text" value="9977 N. 90th St"/>
Address 2 <input type="text"/>	City <input type="text" value="Scottsdale"/>
State <input style="border: 1px solid #ccc; border-radius: 4px; padding: 2px 10px;" type="text" value="Arizona"/> 	Postal / Zip code <input type="text" value="85258"/>

- 4. Add roles, organizations, or projects for the user, and then click **Save**.

The screenshot shows a dialog box titled "Add users" with a close button (X) in the top right corner. It has two tabs: "1 DETAILS" and "2 ROLES", with "2 ROLES" being the active tab. Below the tabs, it says "Roles (2)" and has a "+ Add role" link. There are two rows of role assignments. Each row has a dropdown menu for the role and a dropdown menu for the organization/project. The first row shows "Model mobile" for the role and "S100000 - PKS Inc" for the organization. The second row shows "Model" for the role and "S100000 - PKS Inc" for the organization. Each organization dropdown has an "X" icon, a minus sign, and an information icon. At the bottom of the dialog are three buttons: "Back", "Cancel", and "Save".

The user is now added to the Platform user’s database and has access to the Model application.

For more information, see [User management](#) in Suite administration.

0.3 ENABLE PROJECTS FOR MODEL

The Product integrations global setting lets you select projects to make them accessible in the Model. Model’s product integration must be enabled for each project you want to access in the Load Model Project dialog box.

ENABLE MODEL IN PRODUCT INTEGRATIONS

1. In InEight cloud platform, select main menu > **All projects & organizations**.

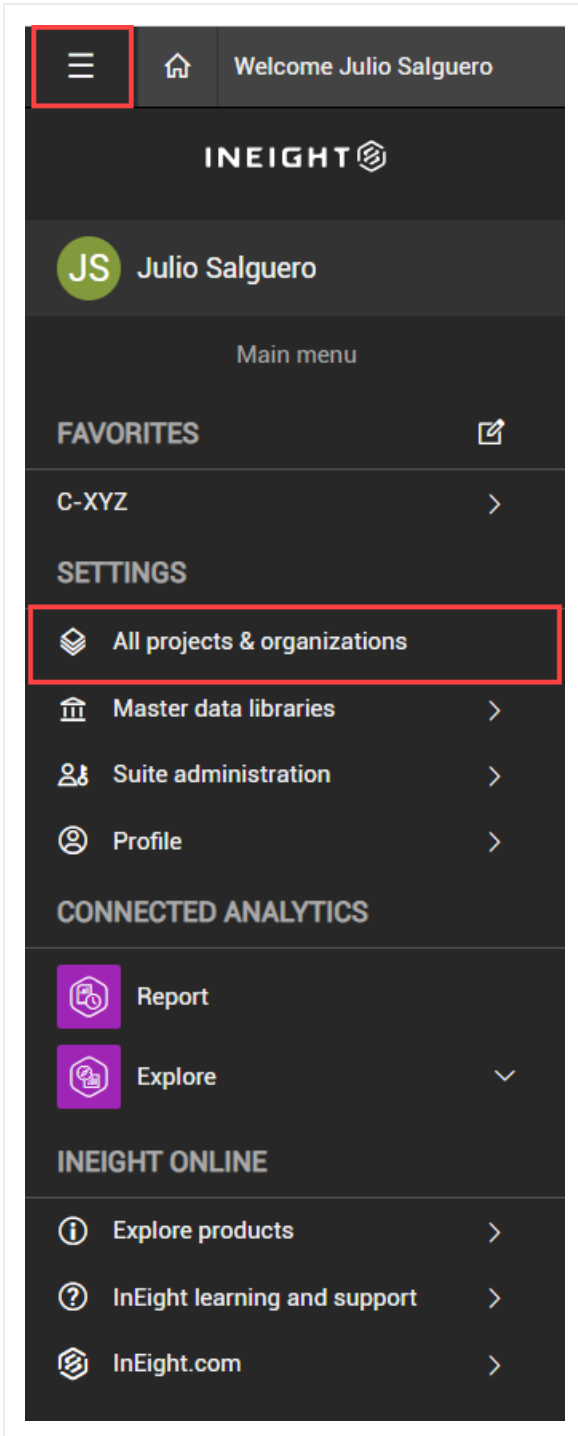

2. In the All projects & organizations page, select a project.

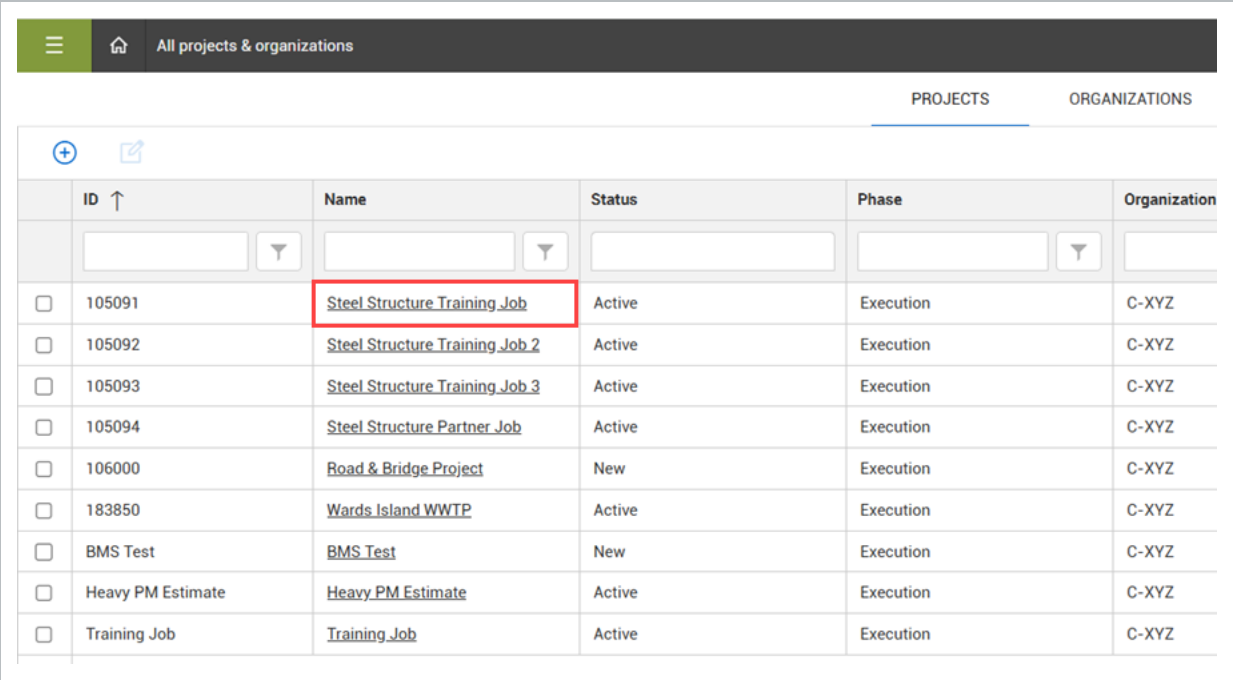

The screenshot shows a web interface for 'All projects & organizations'. At the top, there is a navigation bar with a home icon and the text 'All projects & organizations'. Below this, there are two tabs: 'PROJECTS' (which is active) and 'ORGANIZATIONS'. The main content area contains a table with the following columns: ID (with an upward arrow), Name, Status, Phase, and Organization. The table lists several projects, with the first row, 'Steel Structure Training Job' (ID 105091), highlighted with a red border. Other projects include 'Steel Structure Training Job 2', 'Steel Structure Training Job 3', 'Steel Structure Partner Job', 'Road & Bridge Project', 'Wards Island WWTP', 'BMS Test', 'Heavy PM Estimate', and 'Training Job'. Each row includes a checkbox on the left.

	ID ↑	Name	Status	Phase	Organization
<input type="checkbox"/>	105091	Steel Structure Training Job	Active	Execution	C-XYZ
<input type="checkbox"/>	105092	Steel Structure Training Job 2	Active	Execution	C-XYZ
<input type="checkbox"/>	105093	Steel Structure Training Job 3	Active	Execution	C-XYZ
<input type="checkbox"/>	105094	Steel Structure Partner Job	Active	Execution	C-XYZ
<input type="checkbox"/>	106000	Road & Bridge Project	New	Execution	C-XYZ
<input type="checkbox"/>	183850	Wards Island WWTP	Active	Execution	C-XYZ
<input type="checkbox"/>	BMS Test	BMS Test	New	Execution	C-XYZ
<input type="checkbox"/>	Heavy PM Estimate	Heavy PM Estimate	Active	Execution	C-XYZ
<input type="checkbox"/>	Training Job	Training Job	Active	Execution	C-XYZ

3. In the Project home section, click **Settings**.

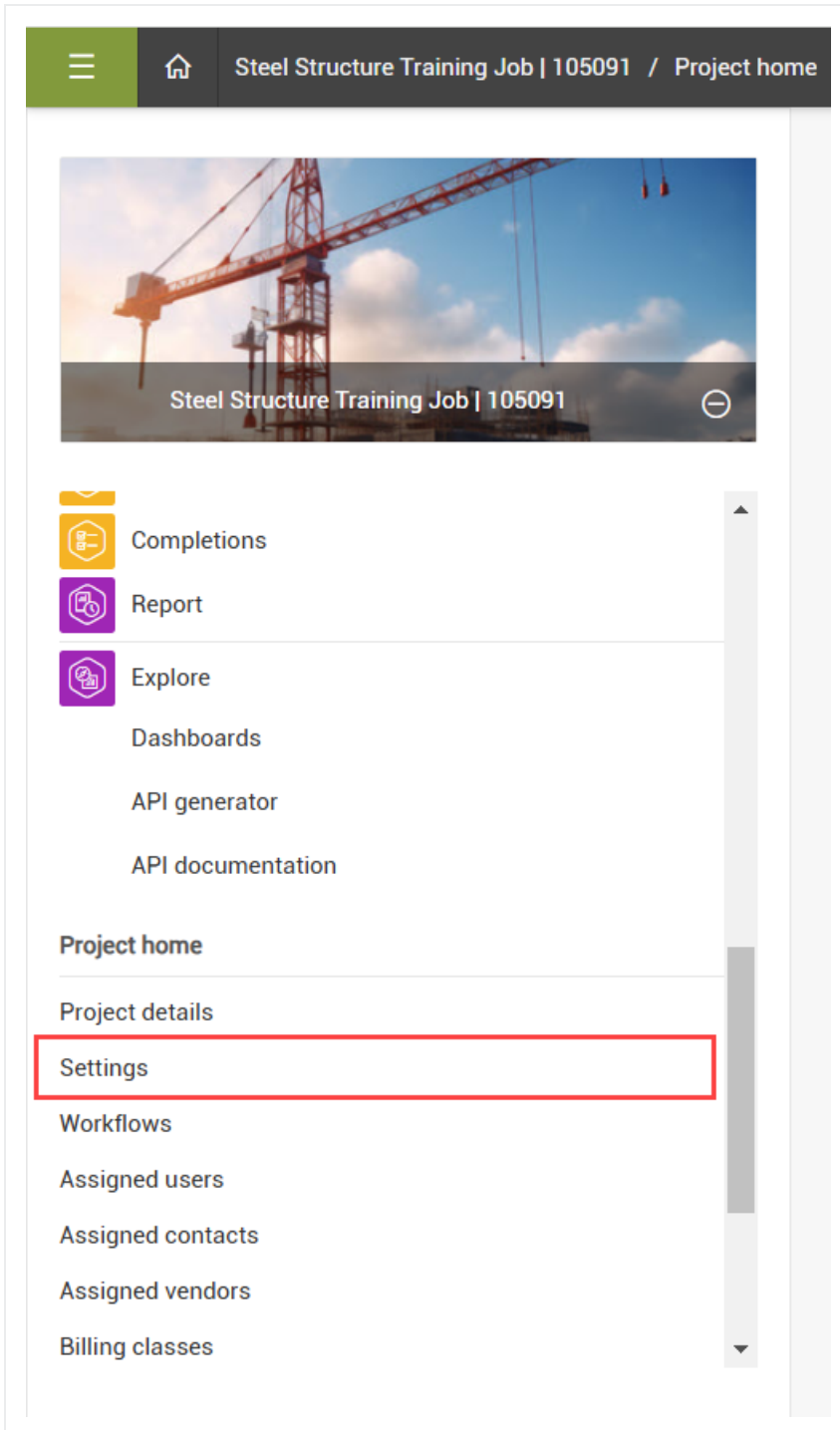

4. In the Global Options tab, go to the Product integrations section, and then set the toggle to *On* for Model.

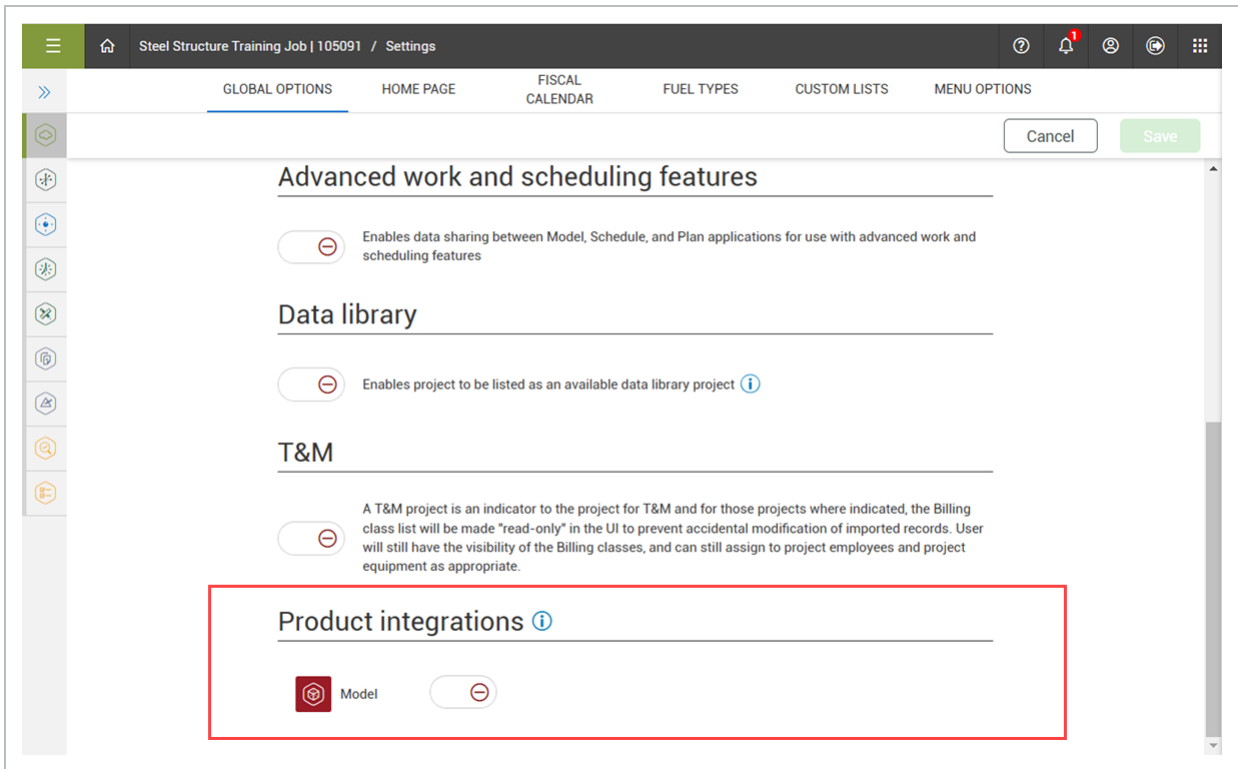

5. Select **Yes** to enable the setting for all non-closed projects.

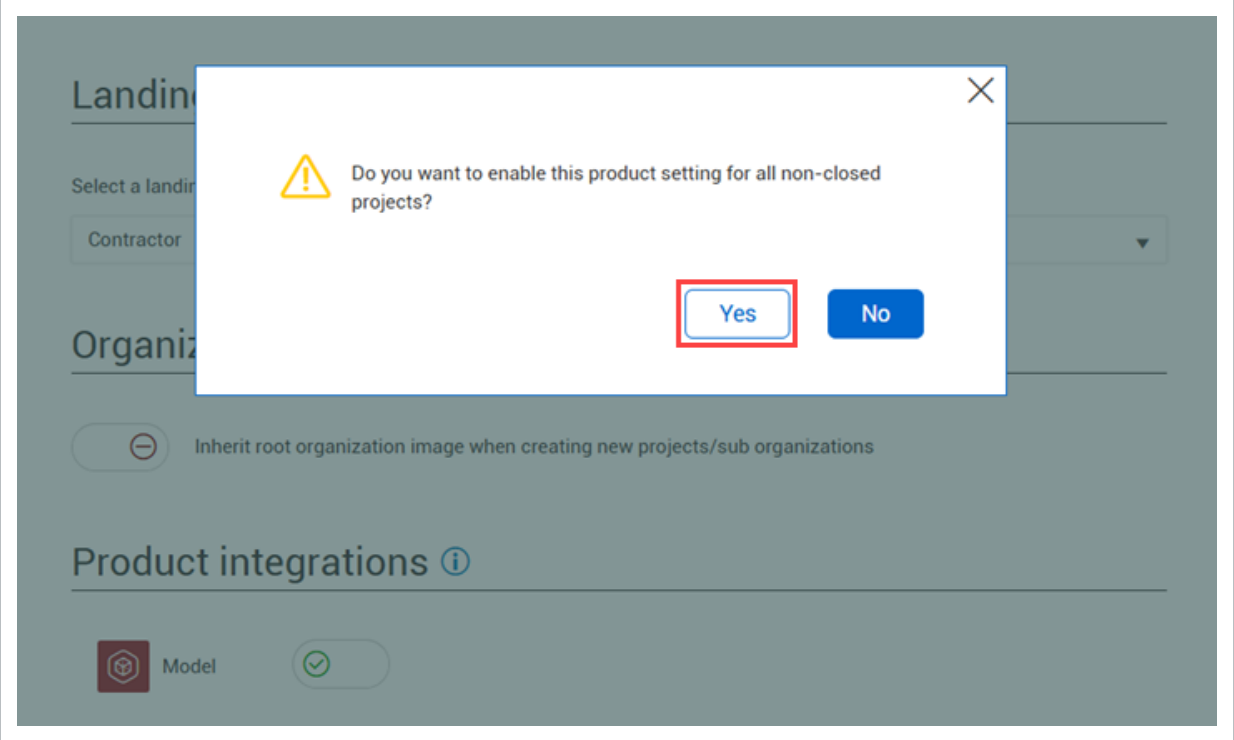

This page intentionally left blank.

CHAPTER 1 – ADMIN TOOLS - MODEL (LEGACY)

1.1 Introduction	37
1.2 Login	38
1.3 Slide-out Panel	42
1.4 Projects	43
1.5 User Access Overview	45
1.6 User Account Management	46

1.1 INTRODUCTION

Admin Tools are not integrated with InEight Platform, therefore it is a central portal for administrators to configure the settings of Legacy Completions, Model projects, and user accounts.

1.1.1 BROWSER COMPATIBILITY

Admin Tools is compatible with the following browsers:

- Chrome
- Firefox
- Safari
- Edge

1.2 LOGIN

Single sign-on (SSO) reduces the need to maintain separate credentials to access Admin Tools. You can use existing credentials to open Admin Tools.

NOTE Conversion to single sign-on (SSO) applies across all InEight Model and Completions applications including Admin Tools and the Excel Plugin.

NOTE You must go through your InEight services representative to convert to SSO.

NOTE One SSO user per email address is permitted in an account.

The login screen lets you use a single set of credentials and authenticate with SSO provider (Google or Microsoft) to sign into any projects that you have access to. SSO increases administrative efficiency by mitigating new user creation. Existing users can continue to sign in using their existing user name and password.

SSO authentication reduces the need to maintain separate credentials, and also minimizes the need to maintain a standalone set of credentials.

To enable SSO functionality for your organization, contact your account administrator.

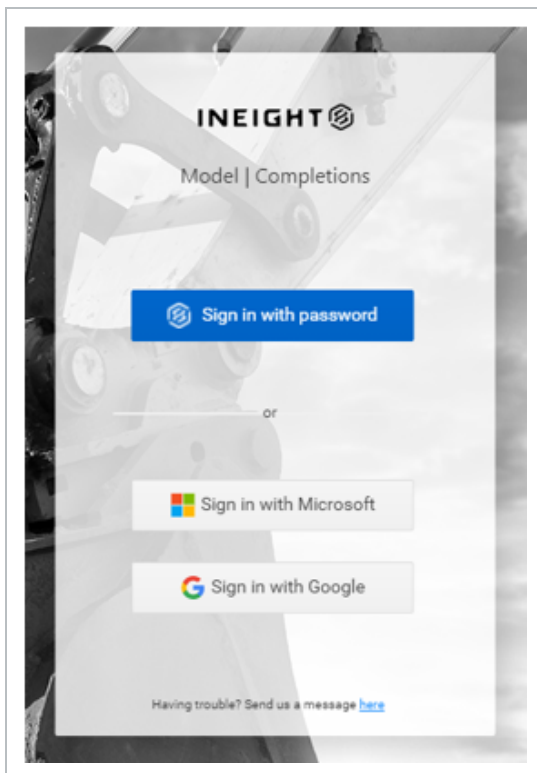

User organizations can integrate with the Excel Plugin authentication service with their own existing authentication servers, which eliminates the need for standalone Excel Plugin user credentials.

Single sign-on recognizes which accounts users have access to, and presents a helpful account drop-down list. Authenticated users are then presented with a list of projects in the selected account that are controlled and assigned by the administrator.

1.2.1 LOG-IN OPTIONS

1.2.1.1 USERNAME AND PASSWORD CREDENTIALS

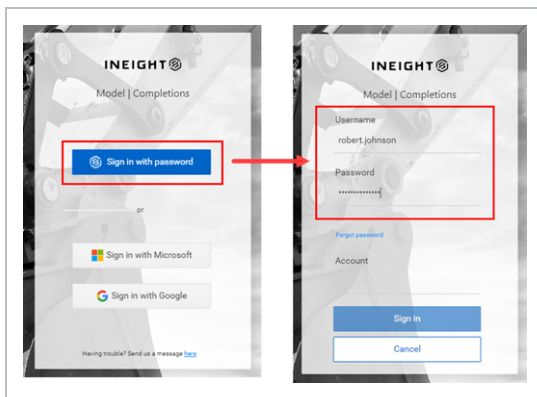

RESET PASSWORD

If you forget your password, click **Forgot password**. Enter your user name, account, and email address, and then click Submit. If your request is successful, an email is sent to you with instructions to complete your password reset. Return to the login page to enter your new password.

NOTE The Submit button is disabled until you enter a valid email address..

1.2.1.2 SSO BY MICROSOFT

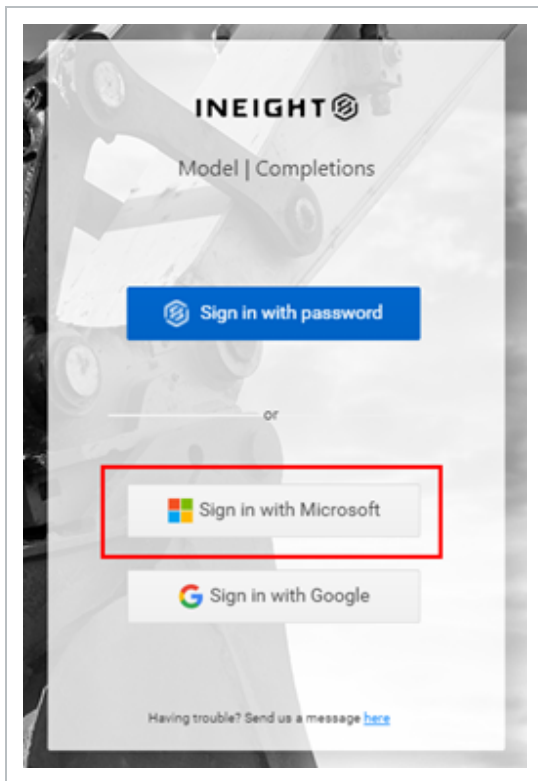

1.2.1.3 SSO BY GOOGLE

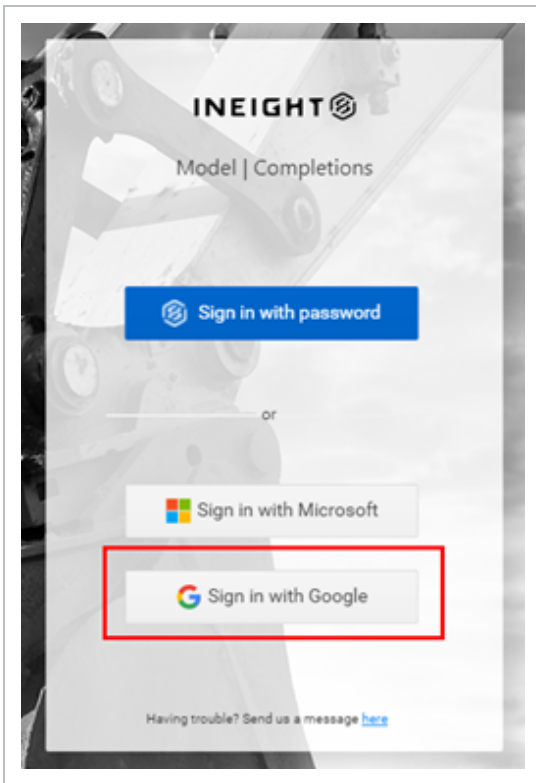

1.2.2 SWITCH ACCOUNT

The Switch account button, located on the lower left panel, lets SSO users change between accounts to access different project lists.

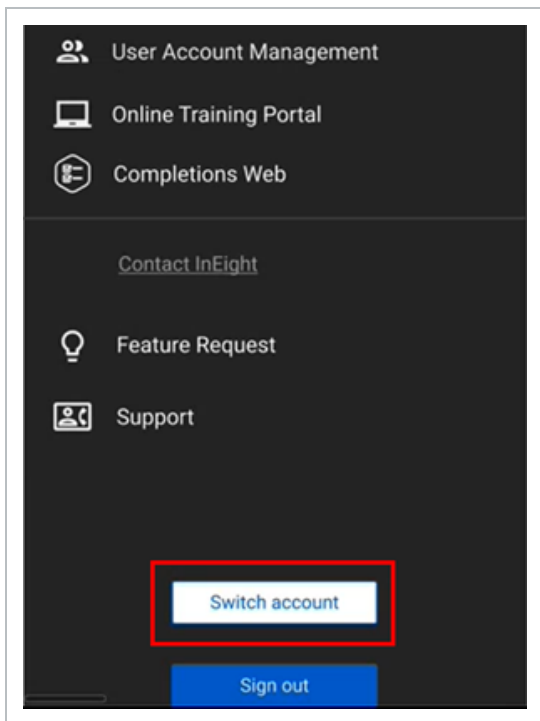

1.3 SLIDE-OUT PANEL

The slide-out panel gives you quick links to pages both inside and outside of Admin Tools. You can also use the slide-out panel to log out of Admin Tools.

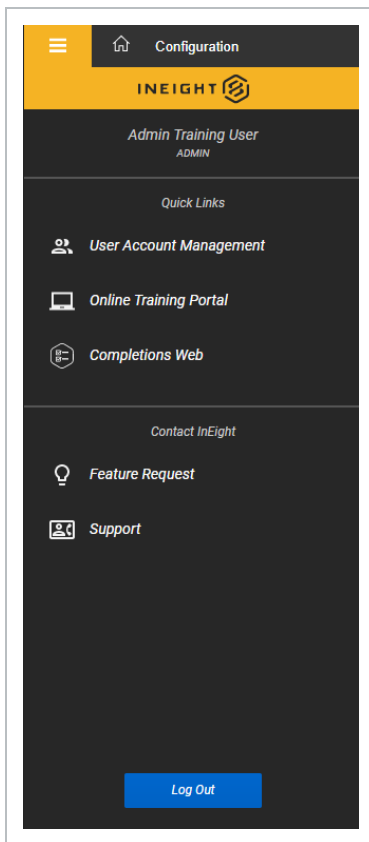

To open the slide-out panel, click the **Main menu** icon.

The slide-out panel contains the following links:

- User Account Management – See [User Account Management](#) for information about this page.
- Online Training Portal – Takes you to the Knowledge Library.
- Completions Web – Opens the Completions web interface in your browser.
- Feature Request – Submit a request for a new feature.
- Support – Opens an email to InEight support.
- Switch Account - Lets SSO users change between accounts to access different project lists.

1.4 PROJECTS

The Projects page shows all available projects. When you log to Admin Tools, the Projects page is the first page that opens. You can also click the Home icon to open the Projects page.

There are several methods to open the Configurations page opens for a specific project:

- Double-click the project **name**.
- Select a project, and then click **Configure**.
- Right-click a project, and then select **Configure** from the drop-down menu.

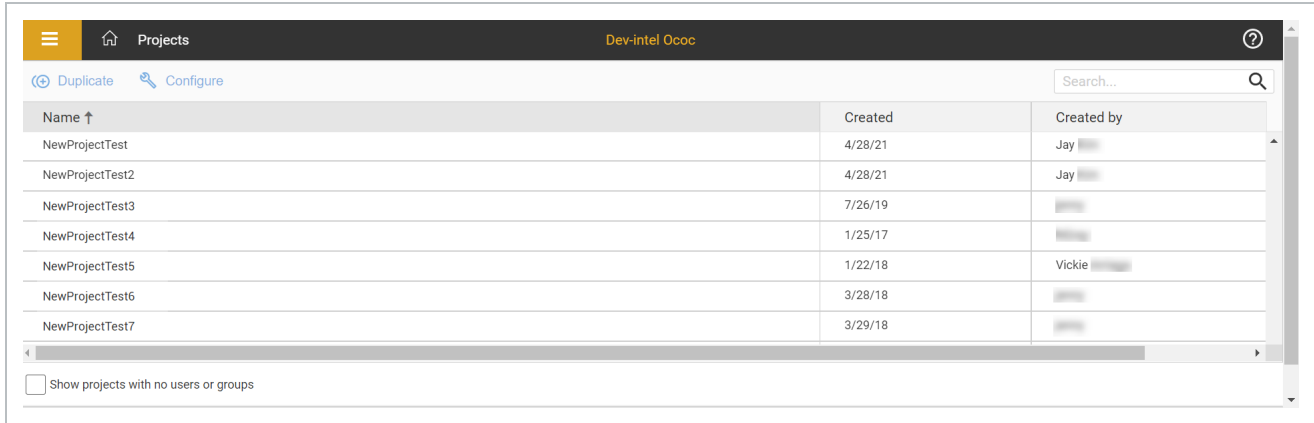

1.5 USER ACCESS OVERVIEW

There are three types of users:

User type	Description
Admin	Allows you to have complete access and control of all functionality in the environment.
Standard	Allows you to have limited access and functionality in a project. You will not be able to: <ul style="list-style-type: none">• Create users.• Create projects.• Delete an object in Viewer.
Read-Only	Allows you to have read-only rights to a project. You can access and utilize all functionality in a project. You will not be able to: <ul style="list-style-type: none">• Save any changes to a project.• Create users.• Create a project.• Publish models.

The default user type is Standard. You can assign a user type when creating a new user.

Users	Admin Portal	InEight Model																						
		Create Projects	Manage Users	Import Model Streams	Import Model Streams - Model Groups	Project Structure	User Interface	Delete Objects	Project Updates	Tags & Objects	Data Transformation Operations	Styles	Master Presets	Coordination Rules	Create Coordination Issues	Manage Coordination Issues	Archive Library	Archive Library Folder Permissions	Selection Info	Sectioning	Measurement	Elements	AWP	
ADMIN	✓	✓	✓	✓	✓ ¹	✓	✓	✓ ²	✓	✓	✓	✓	✓	✓	✓	✓	✓	✓	✓	✓	✓	✓	✓	✓
STANDARD	✗	✗	✓	✓	♦	✓	✗	✓	✓	✓	✓	✓	✓	✓	✓	✓	✓	✗	✓	✓	✓	✓	✓	✓
READ_ONLY	✗	✗	✗	✗	♦	✓	✗	✓	♦	♦	♦	♦	♦	♦	♦	♦	♦	✗	♦	♦	♦	♦	♦	♦
*Group (Write)	✗	✗	✓	✓	♦	✓	✗	✓	✓	✓	✓	✓	✓	✓	✓	✓	✓	✗	✓	✓	✓	✓	✓	✓
*Group (Read)	✗	✗	✗	✗	♦	✓	✗	♦	♦	♦	♦	♦	♦	♦	♦	♦	♦	✗	♦	♦	♦	♦	♦	♦

✓ Denotes User has full Control
 ♦ Denotes User is able to View
 ✗ Denotes User has no Access

Note ¹ Importing of model streams can be restricted for different Model Groups
 Note ² Objects are not truly deleted, objects are turned invisible to all users in the project for current and future revisions
 Note ³ By Default, Standard Users cannot manage Coordination Issues. InEight can toggle the following to have permissions (Standard user, individual users and/or user groups)

NOTE Users can have Read or Write access to a project.

TIP If a Read Only type user is applied to a project with Write access, they will still only have read only rights to the project.

TIP If a Standard or Admin type user is applied to a project with Read Only access, they will only have read only access.

1.6 USER ACCOUNT MANAGEMENT

User Account Management settings let you manage users, user groups, and access to projects. You can navigate to User Account Management through the quick link in the slide-out panel.

NOTE You must be an account administrator to manage user accounts.

The User Account Management has two tabs:

- Users & Groups – Manage users and user groups.
- Project Permissions - Assign users and user groups to projects.

1.6.1 USERS & GROUPS TAB

The Users & Groups tab has two panels. The Users panel lets you manage users, and the Groups panel lets you manage groups. You can use the buttons in the center of the page to add and remove selected users to and from groups.

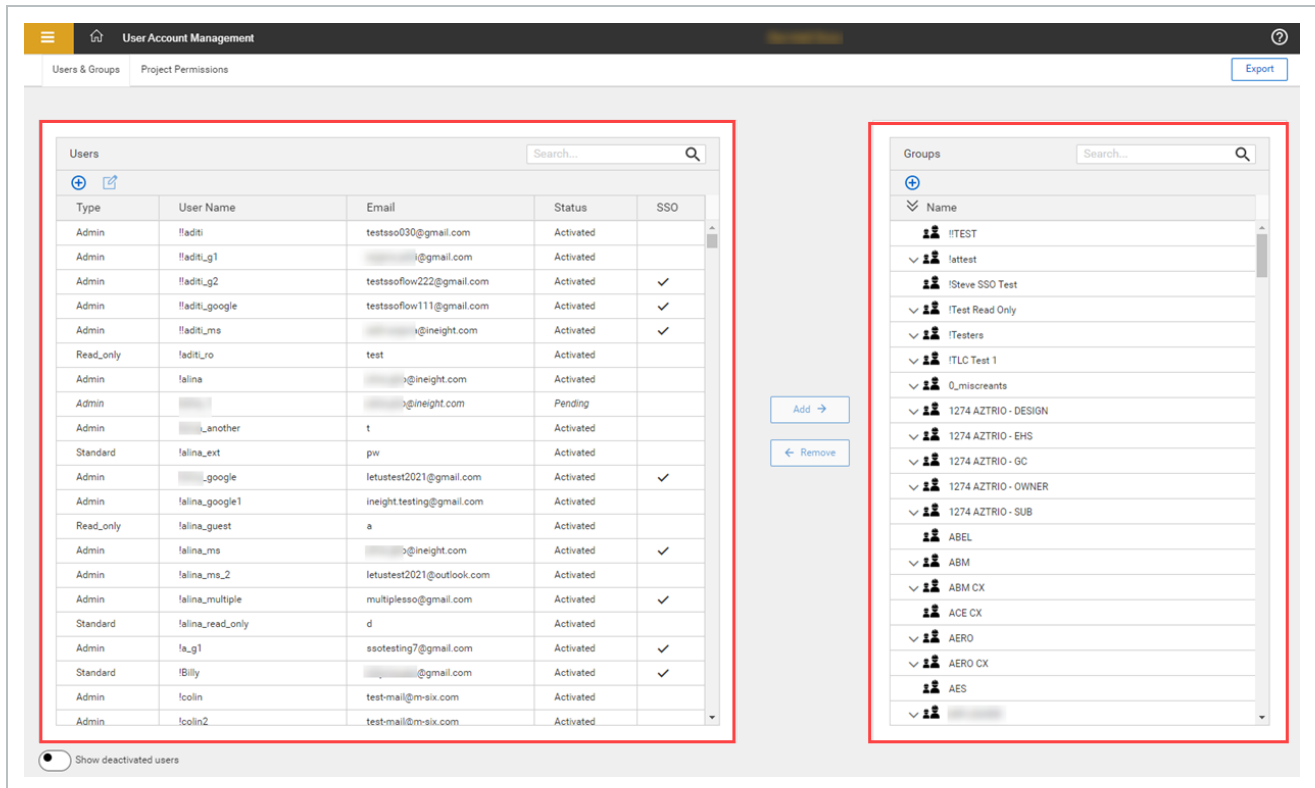

1.6.1.1 USERS

You can select the following user types:

User type	Description
Admin	Create and manage users and duplicate projects.
Standard	Limited access and functionality in a project.

User type	Description
Read-Only	Unable to make changes to a project even if you have other roles that would otherwise allow it.

NOTE

See [User Access Overview](#) for additional information.

1.6.1.2 CREATE SINGLE SIGN-ON OR PASSWORD USER

When creating a new user, the SSO On toggle lets you choose between creating a single sign-on (SSO) user, or a user that logs in using their user name and password. The default setting is *On*. This cannot be changed in edit mode.

ADD USER

1.6 STEP BY STEP 1 – ADD USER

1. Click the **Add user** icon in the Users panel.
The Create User dialog box opens.

The screenshot shows a 'Create User' dialog box with the following fields and controls:

- User Details:**
 - * Email (text input)
 - * Confirm Email (text input)
 - * User Name (text input)
 - * User Type (dropdown menu, currently set to STANDARD)
 - SSO On (toggle switch, currently turned On)
- Contact Info:**
 - * First Name (text input)
 - * Last Name (text input)
 - Work Phone Number (text input)
 - Mobile Phone Number (text input)
- Address:**
 - Address (text input)
 - Title (text input)
- Buttons:** Cancel, Save

2. Fill in the required fields indicated by an asterisk, and then click **Save**.

The SSO toggle lets you choose between creating an SSO user, or as a user that signs in with a user name and password. To add a user that signs in with a user name and password, switch the SSO On toggle to *Off*.

EDIT USER

1.6 STEP BY STEP 2 – EDIT USER

1. Select a user from the Users panel.
2. Click the **Edit user** icon at the top of the Users panel.
You can also right-click a user, and then select **Edit User** in the drop-down menu.
3. Make the updates in the dialog box, and then click **Save**.

NOTE The user name cannot be edited, and the SSO toggle cannot be changed in edit mode.

ACTIVATE USER

To activate a user, right-click the user, and then select **Activate User** in the drop-down menu.

NOTE

To see a list of deactivated users that you want to activate, enable the Show deactivated Users toggle at the bottom of the Users and Groups panel.

DEACTIVATE USER

To deactivate a user, right-click the user, and then select **Deactivate User** in the drop-down menu. A deactivated user can no longer access their account.

RESET A USER'S PASSWORD (SSO OFF)

To reset a user's password, right-click the user, and then select **Reset Password** in the drop-down menu. The user receives an email with instructions and a link to reset their password.

SET A USER'S TEMPORARY PASSWORD (SSO OFF)

To set a temporary password for a user, right-click the user, and then select **Set Temp Password** in the drop-down menu. A temporary password lets you manually set a new password for the user.

DELETE A PENDING USER

To delete a pending user right-click the user, and then select **Delete User** in the drop-down menu.

NOTE

You can only delete pending users for non-SSO users.

RESEND ACTIVATION EMAIL (SSO OFF)

To resend an activation email to a pending user, right-click the user, and then select **Resend Account Activation Email** in the drop-down menu.

1.6.1.3 GROUPS

Groups are made up of multiple users. You can assign multiple users to projects using groups.

ADD A GROUP

To add a new group, click the **Add group** icon at the top of the Groups panel. In the dialog box enter a group name, and then click **Save**.

DELETE A GROUP

To delete a group by right clicking a group, and then selecting **Delete Group** in the drop-down menu.

NOTE A group must unassigned to be deleted.

RENAME A GROUP

To change a group's name, right click a group, and then select **Rename Group** in the drop-down menu.

NOTE The new group name is shown in all historical data about the group.

1.6.2 PROJECT PERMISSIONS TAB

The Project Permissions tab has two panels. You can add and remove selected users and Groups As Teams using the center buttons.

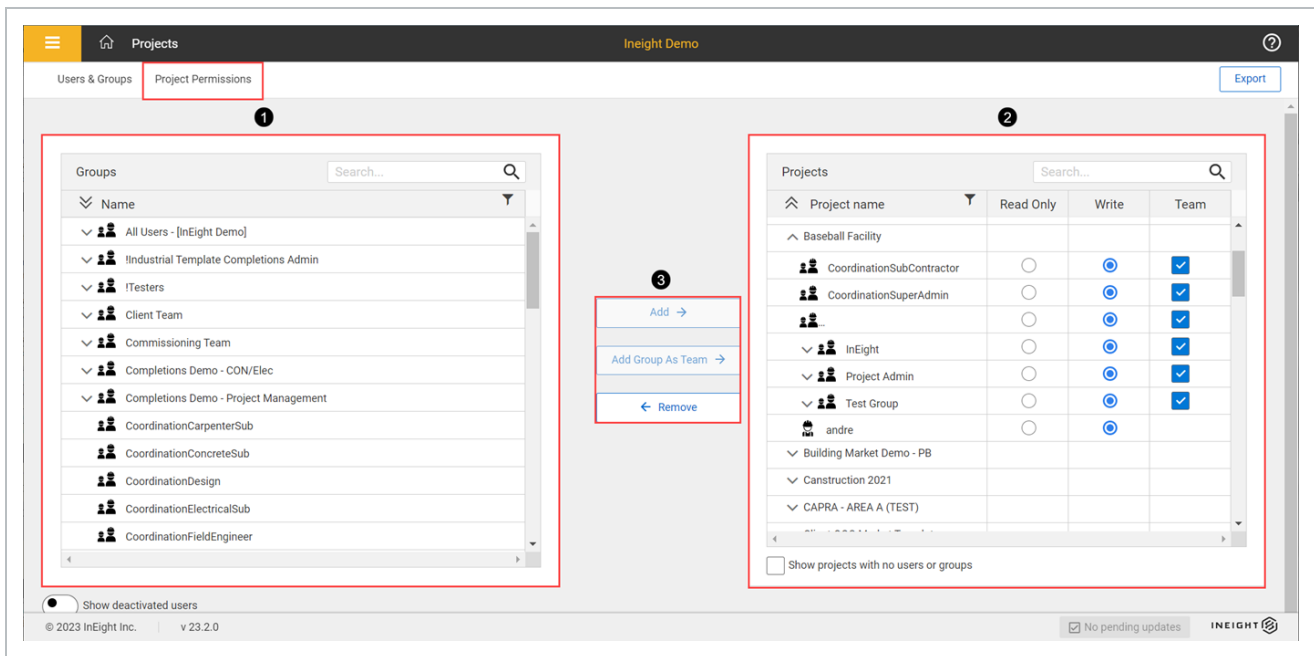

	Item	Description
1	Groups panel	Shows groups and their users.
2	Projects panel	Shows projects and the users and groups assigned to each project. You can manage user and group access to a project
3	Add, Remove, and Add Groups As Team	You can use the buttons in the center of the page to add and remove selected users and Groups As Teams to and from projects.

NOTE Every user must be on a team but can only belong to a single team per project. Failure to assign a user to a team for a given project will result in a misconfiguration error.

NOTE Best practice is to add Groups As Teams to projects instead of adding individual users.

Users and Groups As Teams have the following access types:

- Read Only – Unable to make changes to a project even if they have roles that would otherwise allow it.
- Write - The default access given to a user or group.

NOTE If you used the Add button, you can then simply click the checkbox in the Team column.

1.6.3 EXPORT

You can export a Microsoft Excel file with user information and to which projects users are assigned to. Export files are useful for audits.

To export, click **Export** in the top right of the page to download the file.

CHAPTER 1 – INSTALLATION

1.1 INSTALLATION

InEight Model is cloud-hosted software with a Microsoft Windows-based application focused on 3D model content. Model is not a model-authoring environment; rather, it provides the capability to transform engineering and architectural models into construction and owner models.

The Model Windows application is supported by plug-ins and a locally stored cache folder (InEightModel_Cache). Before you download and run the Model application on your desktop, review the [Client System and Mobile Device Requirements Specification](#).

NOTE

Local admin permissions are required to install InEight Model.

1.1.1 MODEL (INTEGRATED WITH PLATFORM)

In Model (integrated with Platform) you can create projects, user accounts, and assign permissions from Platform to have a unified user, project, and permission experience. When you create a new user account, the user receives a *Welcome to InEight* email with SSO login information.

You can install Model using the Welcome to InEight email you received when you were added to InEight Suite. When you install Model you can create a new project or select an existing project.

INSTALL INEIGHT MODEL INTEGRATED WITH PLATFORM

1. Click the **Login** button below the Login information section of the InEight welcome email. The InEight landing page opens.

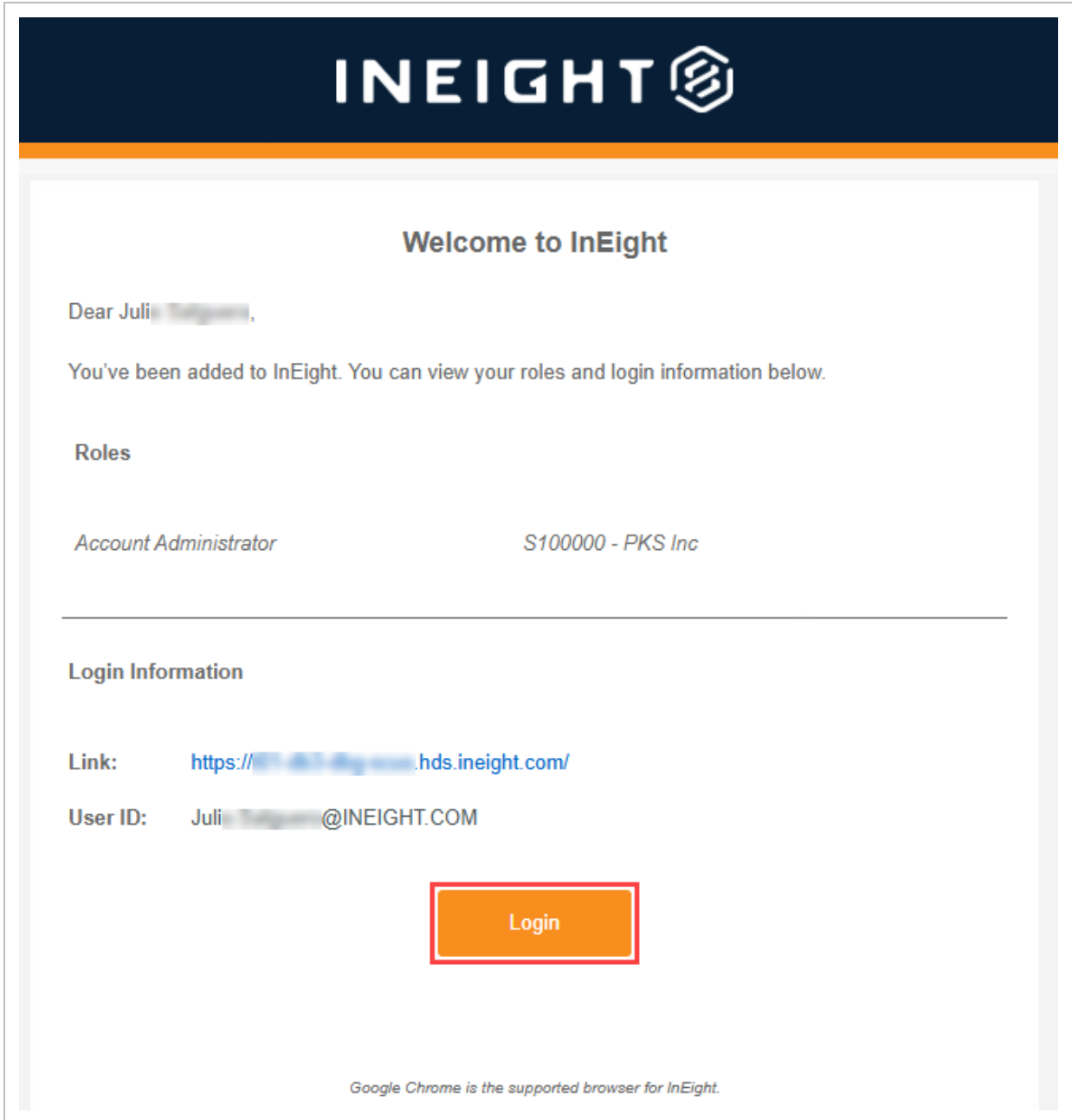

NOTE To easily find the InEight landing page, you can save this page as a favorite in your browser.

2. Click Main menu > **All projects & organizations.**

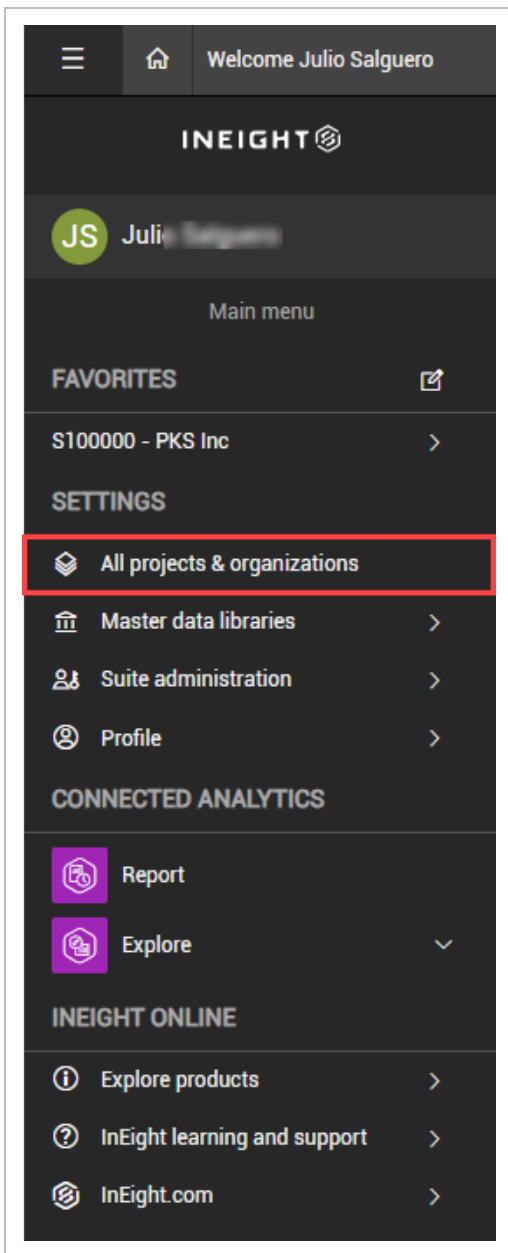

- To create a new project, click the **Add project** icon, and then enter information in the required and any optional fields.

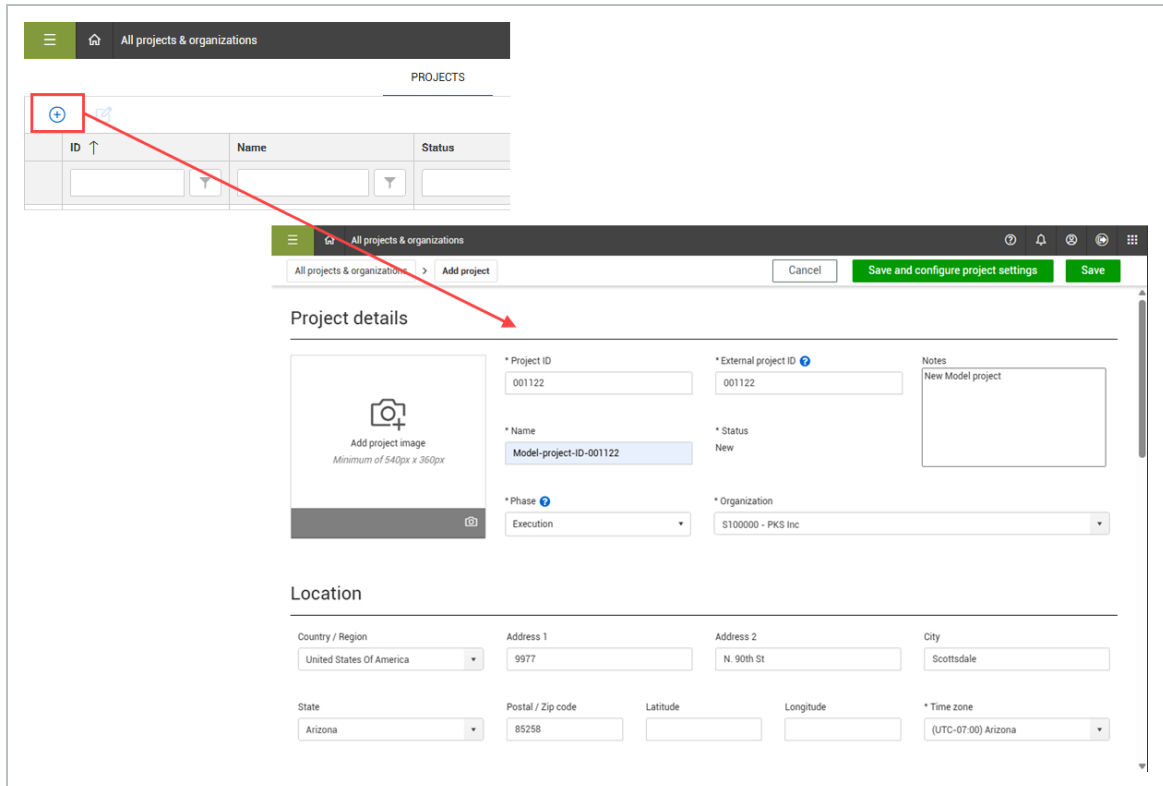

- To open an existing Model project, click the project link to open.

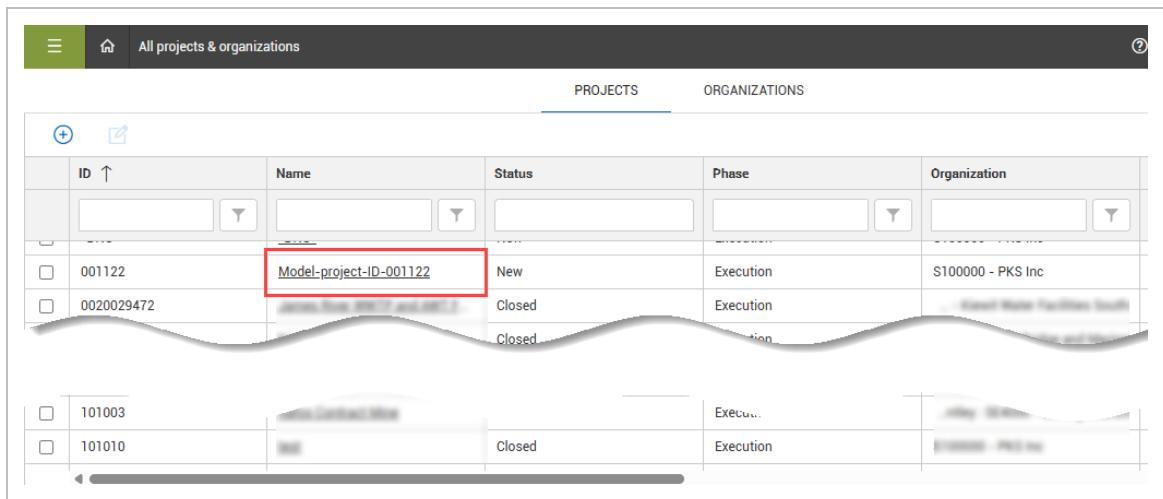

3. On the project page, click **Model**

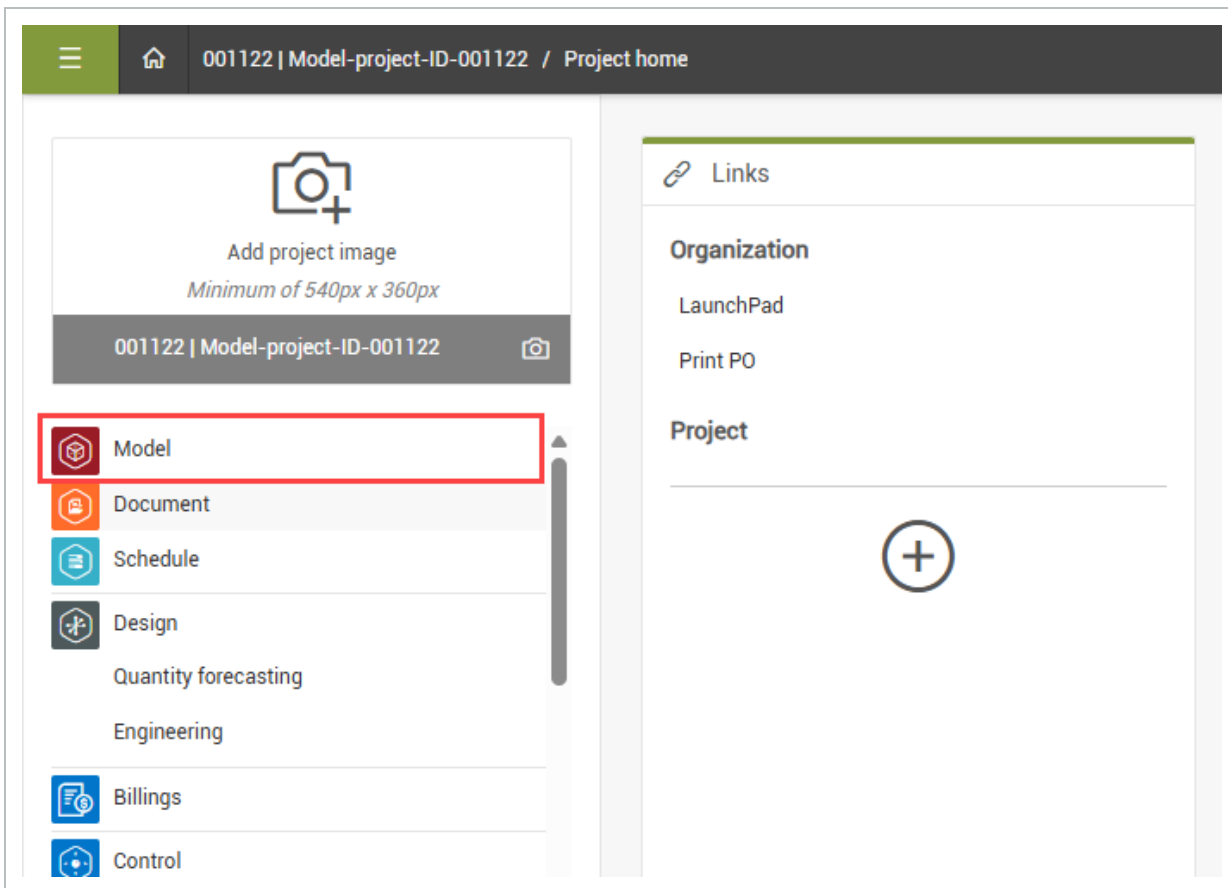

4. When you select Model from the Project home page for the first time, you must click **Download** to save the Model Launcher file to your computer.

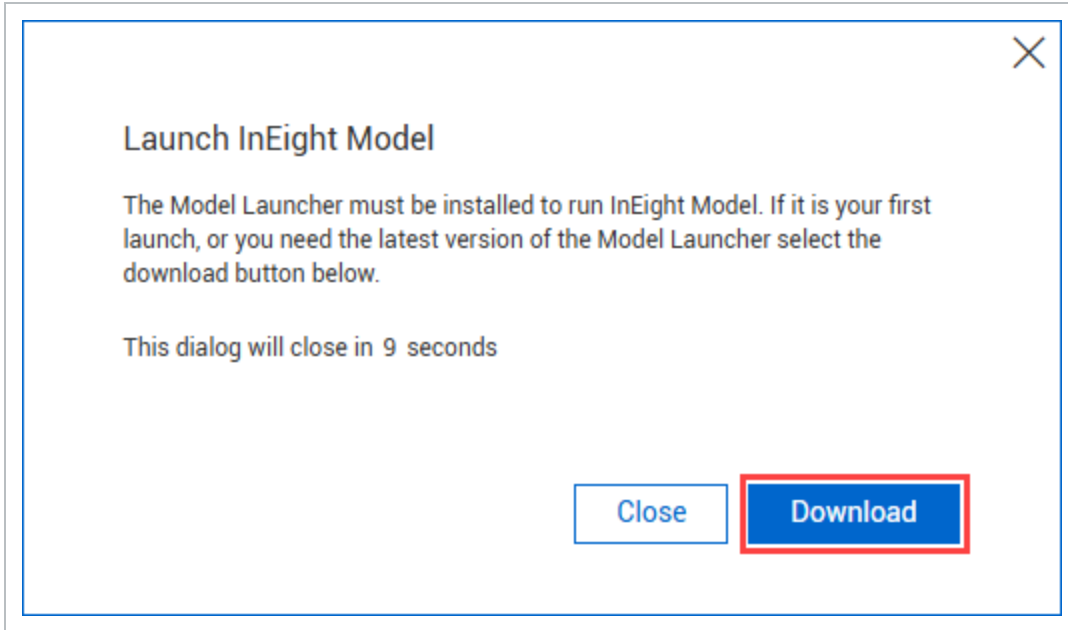

5. Save the **InEightModel.exe** file to your device.

NOTE

You can alternatively go to <https://ineight.com/ineight-software-downloads/> in your web browser, and click **Model Installer – Download** under InEight Model to begin downloading the **InEightModel.exe** file to your computer. After the download is complete, double-click the file to run the application.

6. Double-click the **InEightModel.exe** file to open the Model Launcher Setup window to install Model.
7. Sign in to Model using your credentials and account.

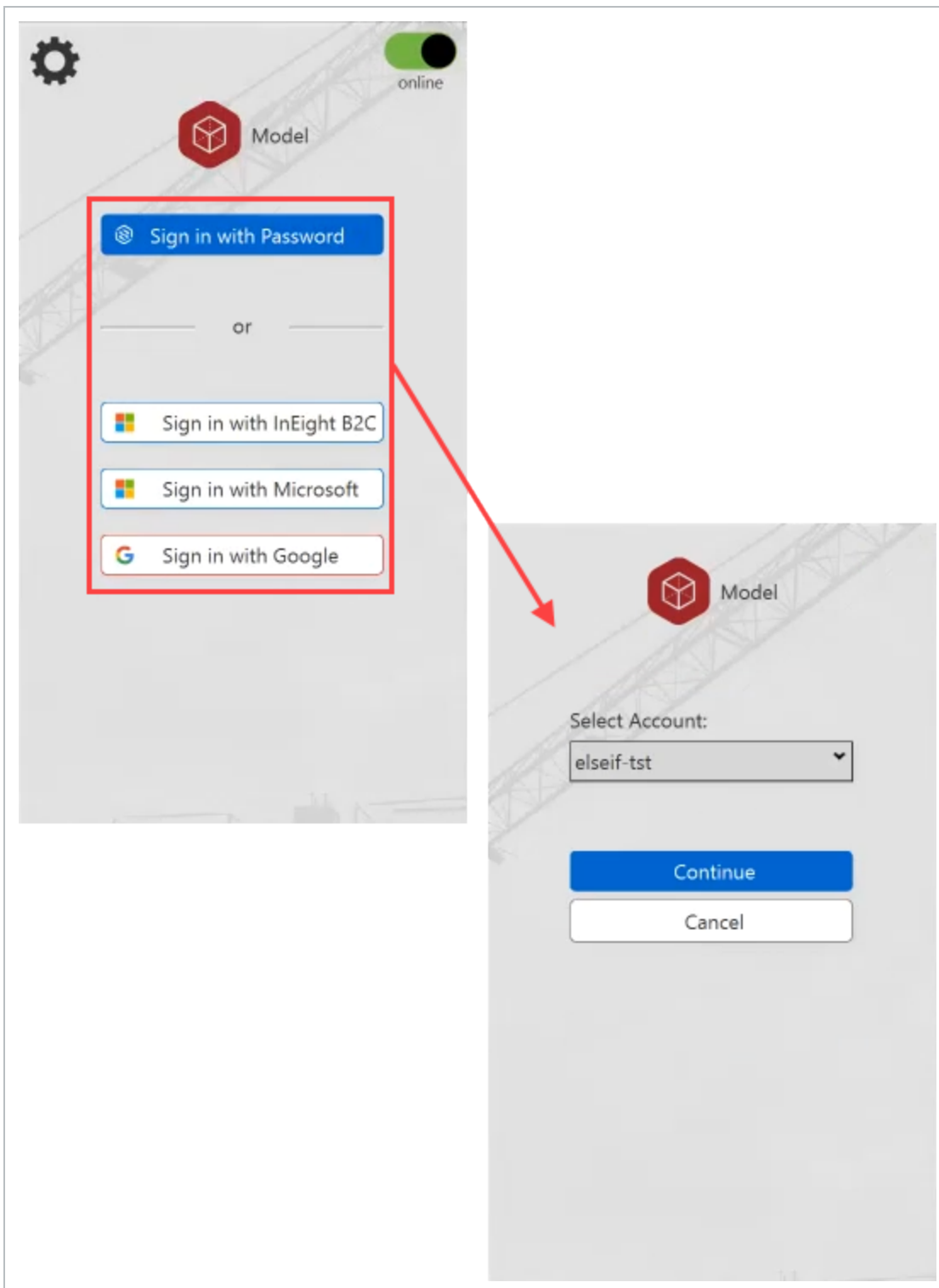

8. In Model, you can click File > **Load project** to open a Model project.

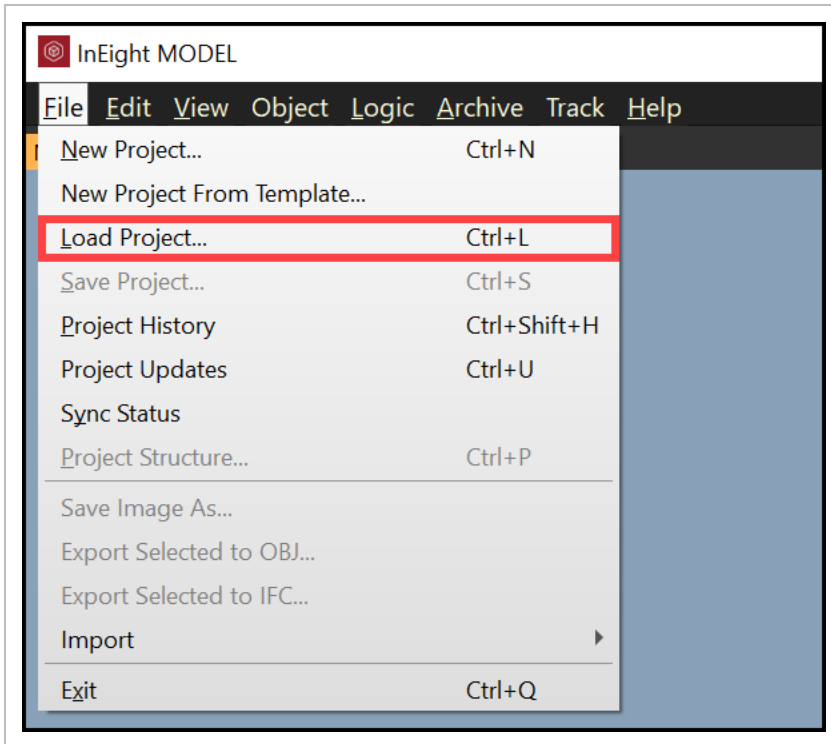

The Load Project dialog box shows Model projects created in Platform.

1.1.1.1 CONSIDERATIONS

- To access Model, you must be set as an active user with applicable Model permissions in InEight Platform.
- The project must be enabled for Model in the project's Global Option's Product integrations section.
- The Load Project dialog box shows Model projects from Platform.

1.1.2 MODEL (LEGACY)

INSTALL THE INEIGHT MODEL DESKTOP APPLICATION

1. Go to <https://ineight.com/ineight-software-downloads/> in your web browser.
2. Under InEight Model, select **Model Installer - Download** to begin downloading the **InEightModel.exe** file to your computer.
3. After the download is complete, double-click the **InEightModel.exe** file to run the application.

1.2 PLUG-INS

You can add InEight Model content from an authoring application using plug-ins or through IFC import. Each model imported to Model is considered a Model stream. For more information, see [Model streams overview](#).

Plug-ins are installed automatically as part of Model Application installation. When you update Model, the plug-ins are also updated. The plug-in applications must be closed when Model is updated.

NOTE When a plug-ins does not update, close and re-open the plug-in application to update the plug-in.

The plug-ins listed below are installed and updated, except for the Microsoft Excel plugin.

Plug-in	Description
Excel plugin (Windows)	Microsoft Excel provides a means to add custom data into Model and a means for visual reporting.
Revit plugin (Windows)	The Revit plugin provides a means for exporting models from Revit into Model.
AutoCAD plugin (Windows)	The AutoCAD plugin provides a means for exporting models from AutoCAD into Model.
Navisworks plugin (Windows)	The Navisworks plugin provides a means for exporting models from Navisworks into Model.

Plug-in	Description
IFC import (Windows) *	The IFC import provides a means for importing IFC (Industry Foundation Class) type files into Model.

* Internal to Model desktop

1.3 LAUNCH MODEL

After Model is installed, you can launch Model from the InEight cloud platform landing page (when integrated with Platform) or using the Model shortcut in your Windows **Start** menu or the shortcut created on your desktop (for Model legacy). Model has online and offline capabilities, which can be changed on the login screen and within the application. The best practice is to sign in online to ensure your local cache data is up to date with the latest project information, and then use Model offline when needed.

1.3.1 LAUNCH MODEL (INTEGRATED WITH PLATFORM)

LAUNCH MODEL (INTEGRATED WITH PLATFORM)

1. On the Project home page, select **Model** from the list of applications in the menu, and then click **Open VEO_WebLauncher** in the Open VEO_WEBLauncher dialog box.

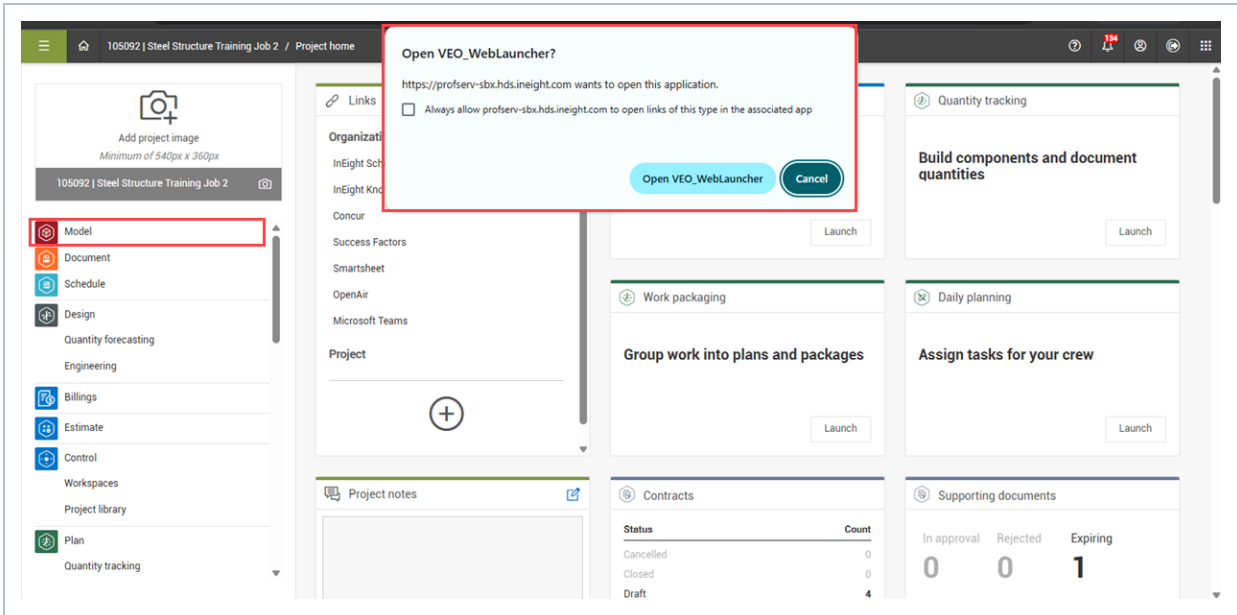

2. In the Model login dialog box, you can sign in using your SSO information provided in the email.

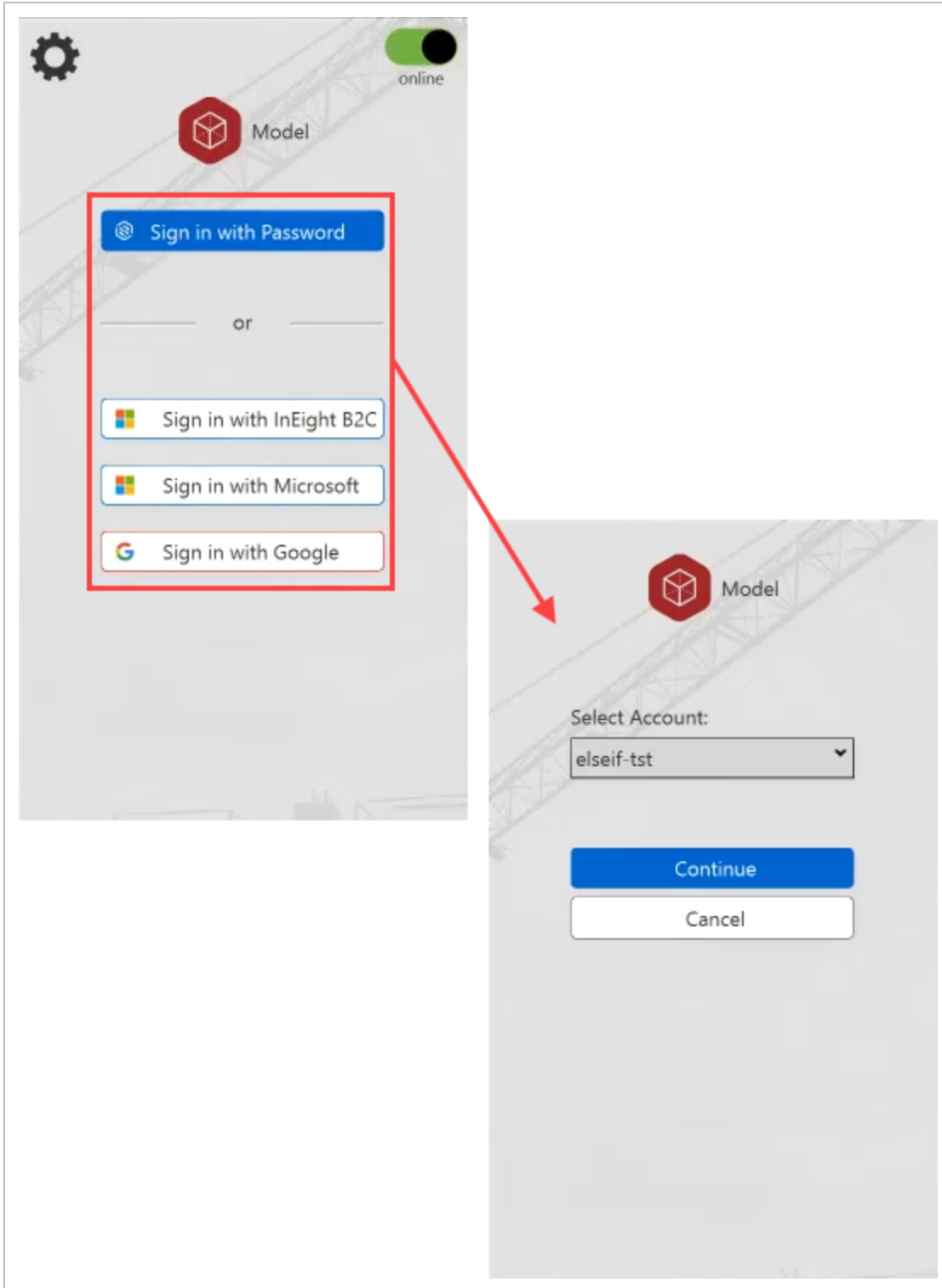

3. Select a project from the **Load Project** dialog box.

NOTE

The Load Project dialog box shows Model projects created in Platform.

1.3.1.1 CONSIDERATIONS

- To access Model, you must be set as an active user with applicable Model permissions in InEight Platform.
- The project must be enabled for Model in the project's **Global Option's Product integrations** section to show in the Load Project list.

1.3.2 LAUNCH MODEL (LEGACY)

In Model (Legacy) you can create projects, user accounts, assign permissions, and assign users to projects. When you create a new user, the user receives an email with login information.

LAUNCH MODEL (NOT INTEGRATED WITH PLATFORM)

1. Click the **Model** icon on your desktop or select **Model** from the Windows Start menu.
2. At the login screen, enter the login information provided in the email. You can also sign in using single-sign-on (SSO).
3. In the Load Project dialog box, select a Model project from the list.

NOTE

The Load Project dialog box shows only the projects that you are assigned to.

1.3.2.2 CONSIDERATIONS

You must have administrative permissions.

1.4 MODEL CACHE

Model stores your project's data in a local folder named cache. The cached project data is accessible when you are offline. To use the project offline, it is recommended to sign in online to sync the latest project information.

The default cache location is %localappdata%/InEight/Model/**cache** directory.

If your existing installation is not in the default location, switching to the default path is highly recommended. To view your current path and update the default location click the ellipsis in your sign in screen > Settings > **Cache Path**. You can then select a new location.

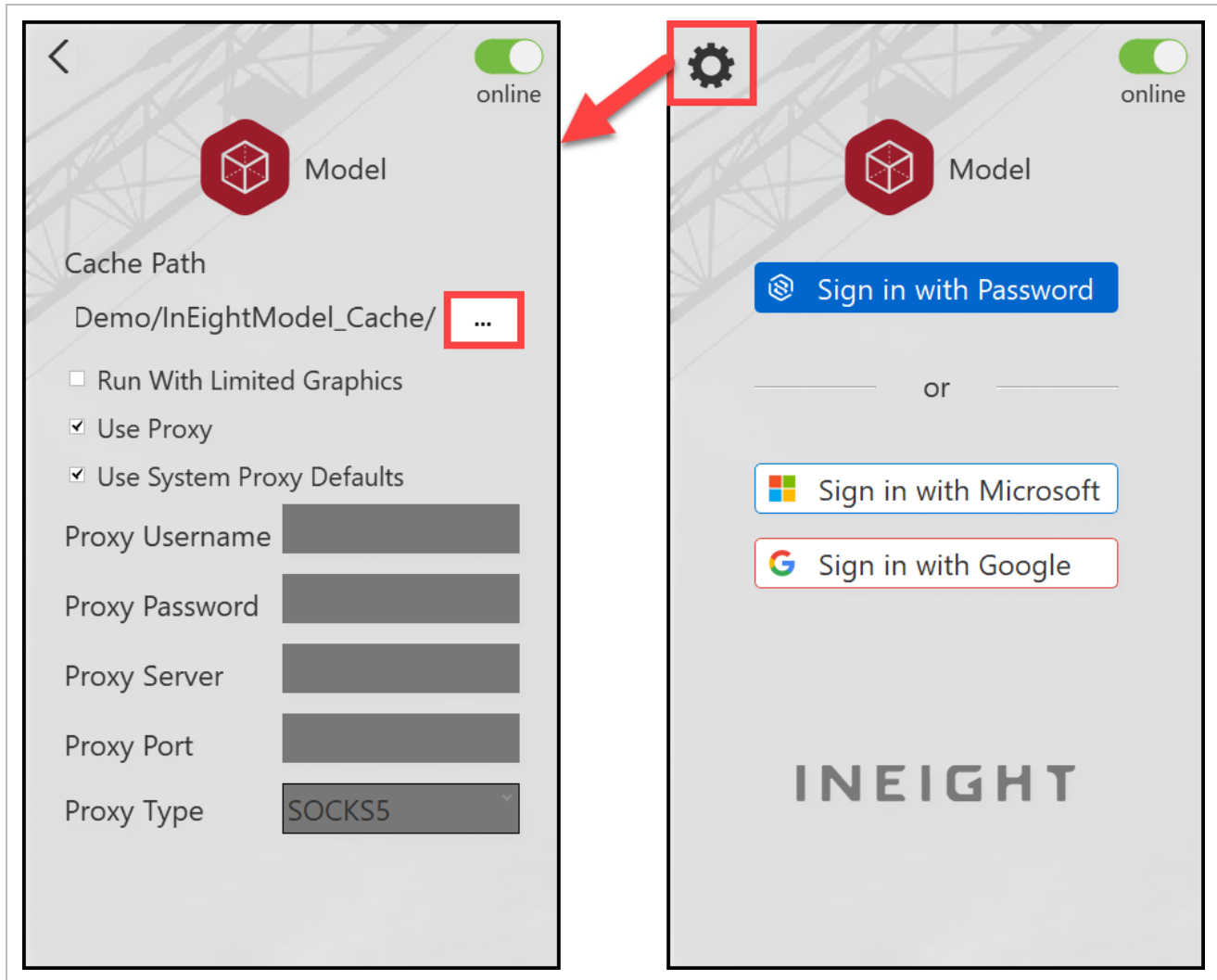

The cache must remain local on the computer and cannot be synced live to external locations.

NOTE Do not delete your InEight Model cache folder. In rare instances you can delete the folder to fix cache issues.

1.4.1 MOVE CACHE TO A NEW LOCATION

If you installed Model before 23.10, you can change the location of your InEightModel_Cache folder in Settings > **Cache Path**. Changing the location of your cache folder without moving your existing cache

folder data will force Model to recache the project data. This can be time-consuming depending on the number of projects and their size.

1.4.2 CONSIDERATIONS

- The registry key located in Computer\HKEY_CURRENT_USER\SOFTWARE\InEight\Model\Cache defines the path of where the InEightModel_Cache folder resides. Updating the path in the registry will not relocate the existing cache folder to a new defined location
- If the cache folder is deleted, Model must re-cache the project data. This can be time-consuming.

1.4.3 STEPS

MOVING YOUR EXISTING INEIGHTMODEL_CACHE FOLDER

To move your existing Model cache folder, do the following recommended process. The process must be done on the local machine of each user.

1. Open Windows File Explorer, and then create a new folder or open the new folder location.
2. Open another Windows File Explorer window, and then select your existing InEight Mode_Cache folder location.
3. Move your existing InEightModel_Cache folder into the new location.
4. Launch the InEight Model application.
5. Click the **Settings** icon in the login window, and then change the Cache Path to the new location.
6. Sign in to InEight Model.

LESSON 1 REVIEW

1. What should you do **prior** to downloading and installing InEight Model?
 - a. Delete your authoring tool from your computer
 - b. Check your system's requirements
 - c. Download the correct plugin for your authoring tool
 - d. None of the above

2. What does InEight Model offer to support authoring tools?
 - a. AutoCAD plugin
 - b. Revit plugin
 - c. IFC importer
 - d. Navisworks
 - e. All of the above

3. You can create a new model from InEight model.
 - a. True
 - b. False

LESSON 1 SUMMARY

As a result of this lesson, you can:

- Install InEight Model
- Install plugins
- Launch InEight Model

This page intentionally left blank.

CHAPTER 2 – PROJECTS

2.1 CREATE A PROJECT

CREATE A PROJECT INTEGRATED WITH INEIGHT PLATFORM

When Model is integrated with InEight Platform, all projects are created in Platform. For more information, see [Project initiation](#) in Platform.

CREATE A PROJECT NOT INTEGRATED WITH INEIGHT PLATFORM

1. From the top menu, select **File > New Project**.

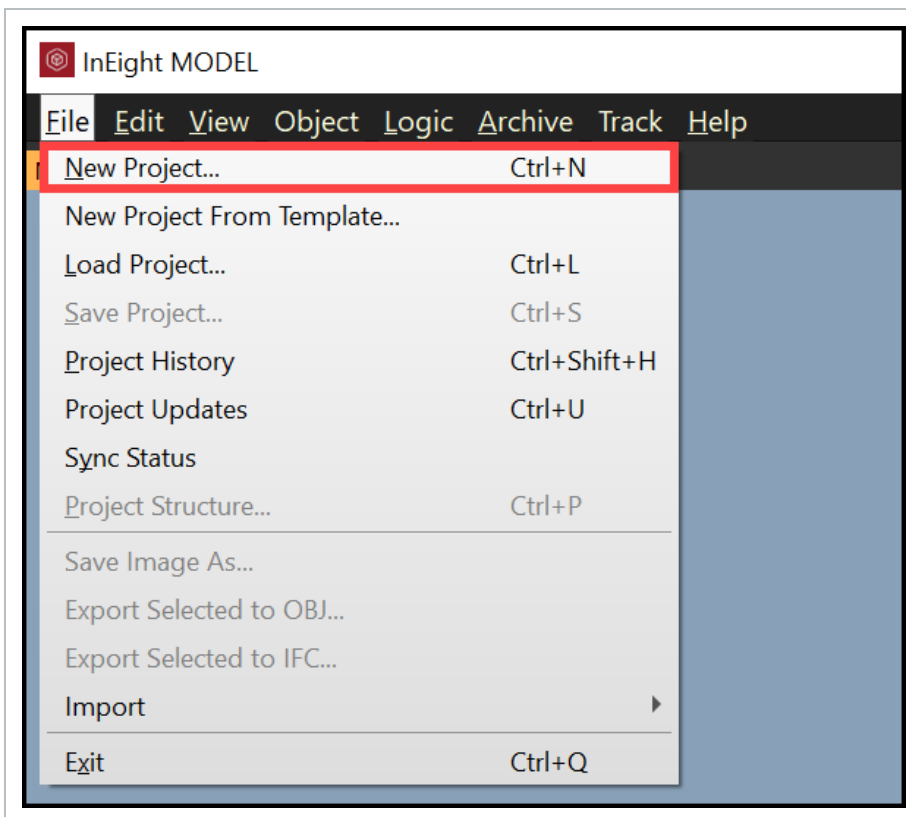

- The New Project dialog box opens.
2. Name the new project.

3. Click **OK**.

- The creation in progress dialog opens.

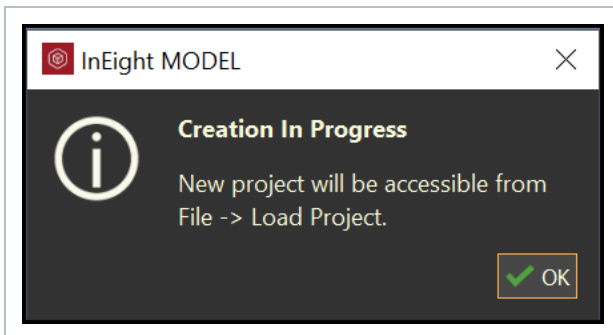

4. Click **OK**.

NOTE After a project is created it cannot be renamed.

2.2 ENABLE PROJECTS FOR MODEL

The Product integrations global setting lets you select projects to make them accessible in the Model. Model's product integration must be enabled for each project you want to access in the Load Model Project dialog box.

ENABLE MODEL IN PRODUCT INTEGRATIONS

1. In InEight cloud platform, select main menu > **All projects & organizations**.

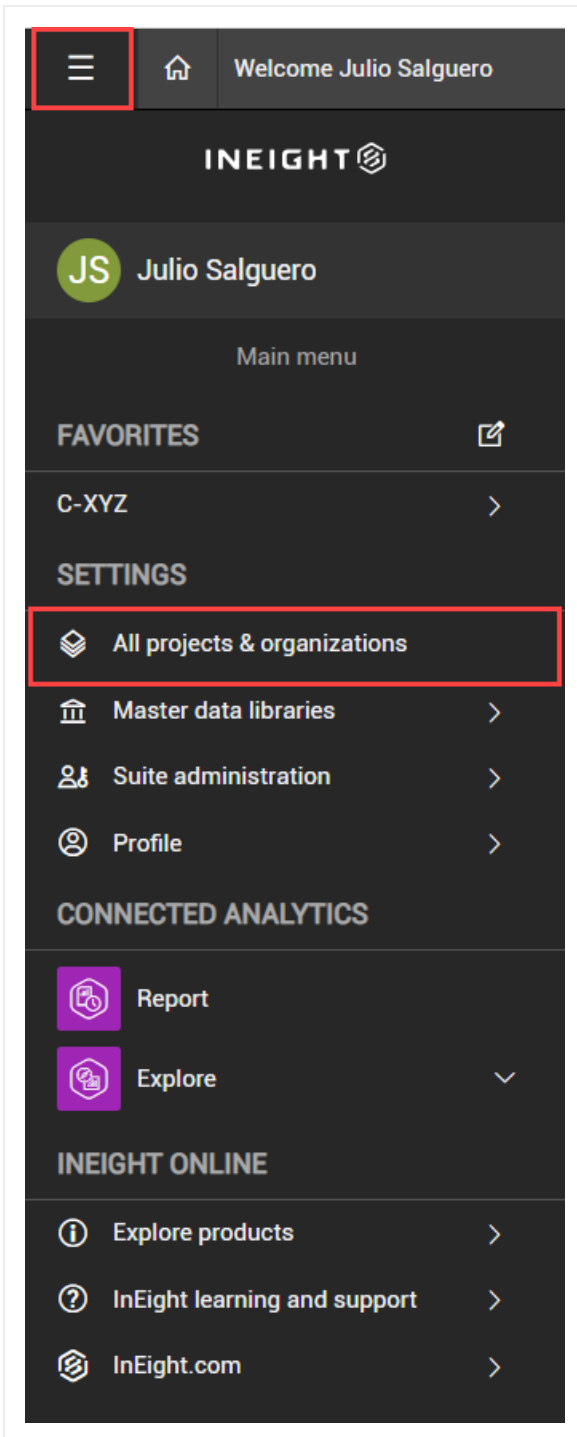

2. In the All projects & organizations page, select a project.

The screenshot shows a web application interface with a dark header bar containing a menu icon, a home icon, and the text 'All projects & organizations'. Below the header, there are two tabs: 'PROJECTS' (active) and 'ORGANIZATIONS'. The main content area features a table with the following columns: ID (with an upward arrow), Name, Status, Phase, and Organization. Each column has a search input field with a dropdown arrow. The table contains ten rows of project data. The first row, 'Steel Structure Training Job', is highlighted with a red border. The other rows include 'Steel Structure Training Job 2', 'Steel Structure Training Job 3', 'Steel Structure Partner Job', 'Road & Bridge Project', 'Wards Island WWTP', 'BMS Test', 'Heavy PM Estimate', and 'Training Job'. All projects are associated with the organization 'C-XYZ'.

ID ↑	Name	Status	Phase	Organization	
<input type="checkbox"/>	105091	Steel Structure Training Job	Active	Execution	C-XYZ
<input type="checkbox"/>	105092	Steel Structure Training Job 2	Active	Execution	C-XYZ
<input type="checkbox"/>	105093	Steel Structure Training Job 3	Active	Execution	C-XYZ
<input type="checkbox"/>	105094	Steel Structure Partner Job	Active	Execution	C-XYZ
<input type="checkbox"/>	106000	Road & Bridge Project	New	Execution	C-XYZ
<input type="checkbox"/>	183850	Wards Island WWTP	Active	Execution	C-XYZ
<input type="checkbox"/>	BMS Test	BMS Test	New	Execution	C-XYZ
<input type="checkbox"/>	Heavy PM Estimate	Heavy PM Estimate	Active	Execution	C-XYZ
<input type="checkbox"/>	Training Job	Training Job	Active	Execution	C-XYZ

3. In the Project home section, click **Settings**.

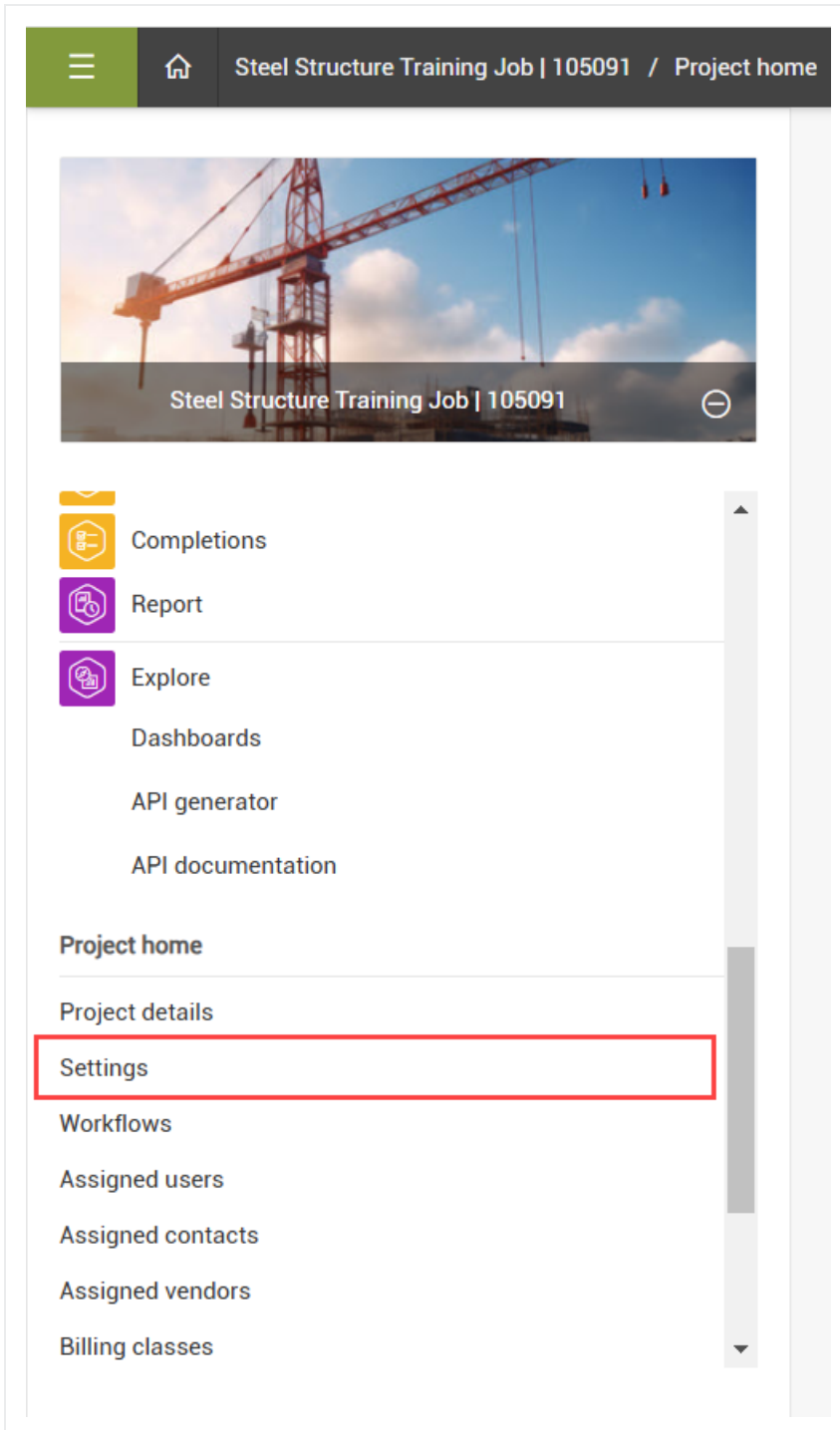

4. In the Global Options tab, go to the Product integrations section, and then set the toggle to *On* for Model.

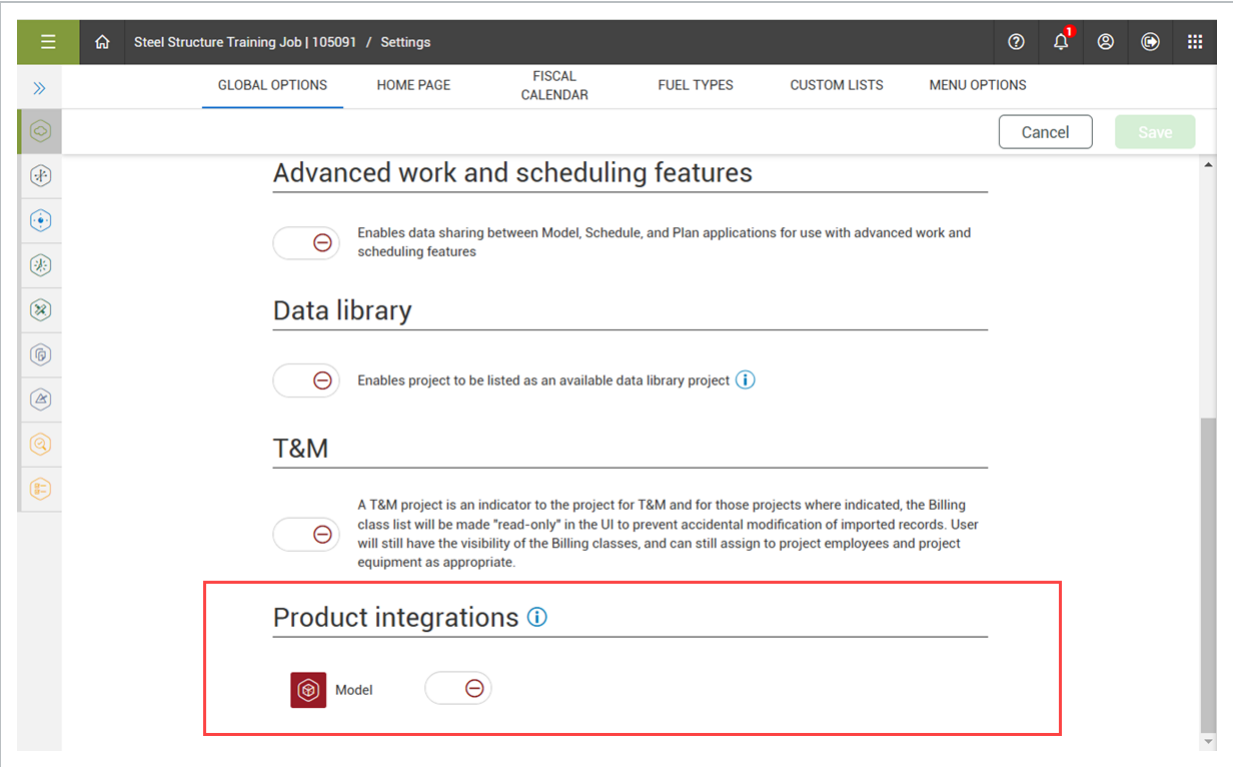

5. Select **Yes** to enable the setting for all non-closed projects.

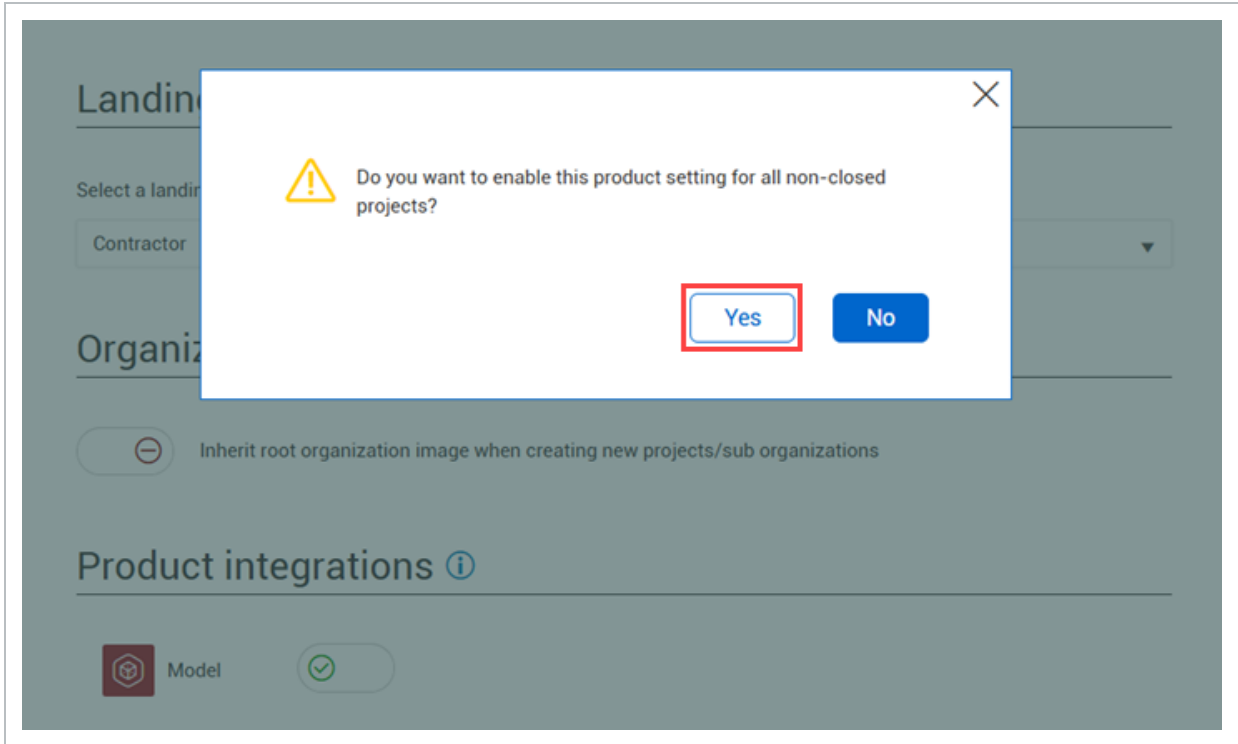

2.3 LOAD A PROJECT

Logging into an account provides access to projects in that account. To access a specific project, you first must load it.

NOTE

InEight Model integrated with InEight Platform will show all projects listed in Platform in the Load Project dialog box.

2.3 STEP BY STEP 1 – LOAD A PROJECT

1. Select File > Load Project....

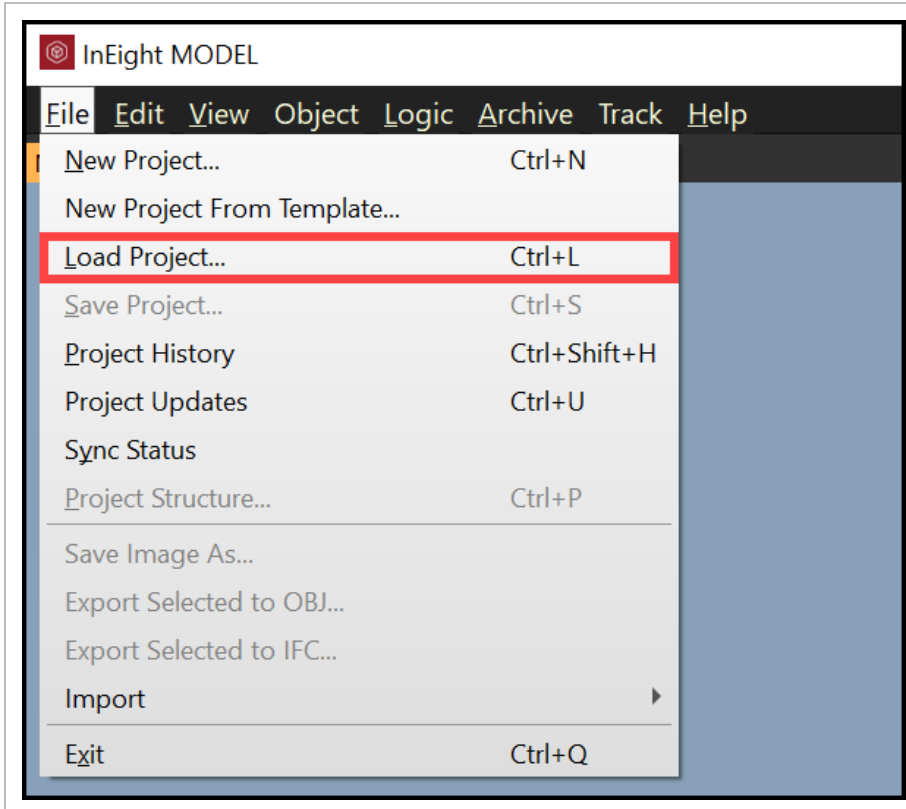

- The Load Project dialog box opens and shows all projects you have access to.

2. Select a project.
3. Select OK.

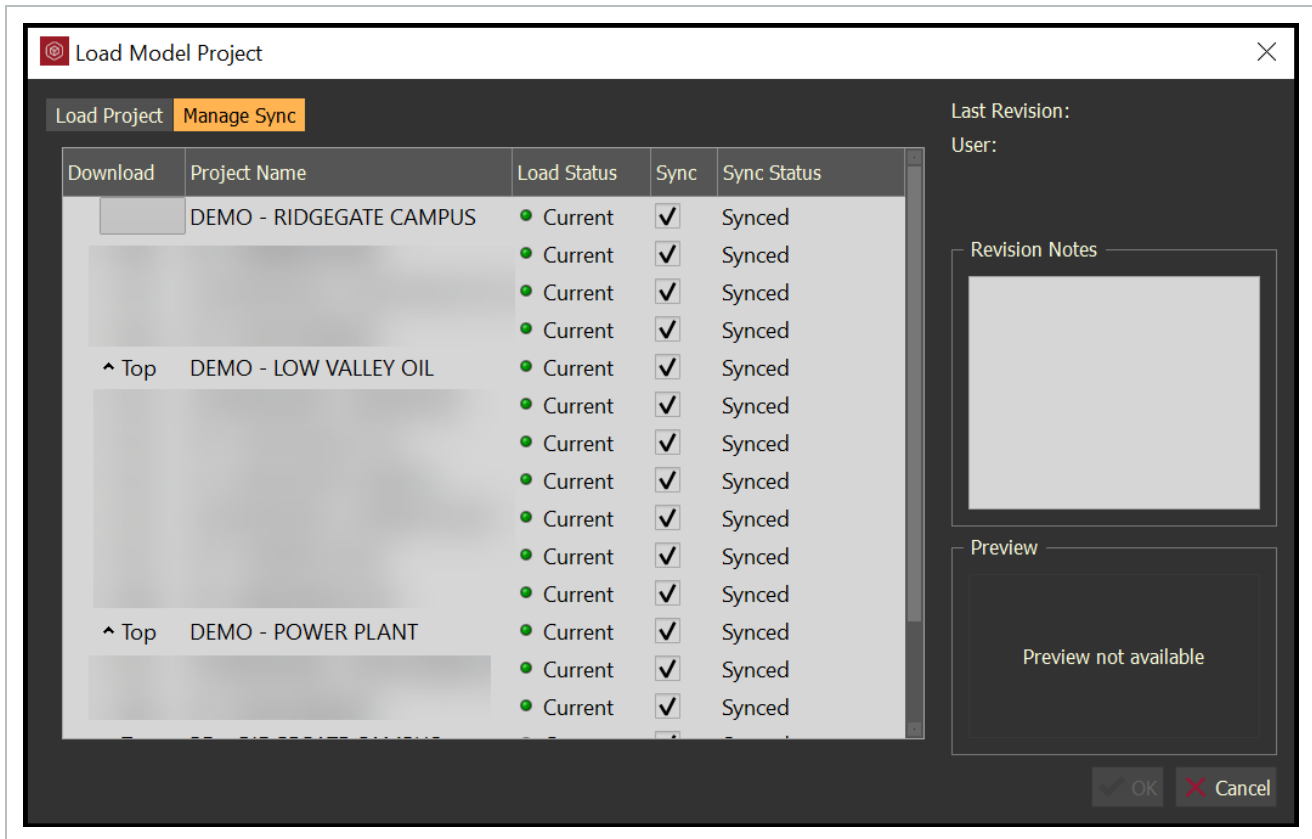

- Download column: select on ^ Top to move a project to the top of the list to be synced first
- Sync column: If Sync is checked, then the project will sync. If Sync is un-checked then the project will not sync

2.3.2 REMOVE PROJECTS FROM CACHE

You now can free up disk space by using the Remove project from cache option. When you finish working on a project, remove the project from your cache in the Load Model Project > **Load Project** tab. Right-click on a project from the list, and then select **Remove Project from Cache** to remove the projects cache.

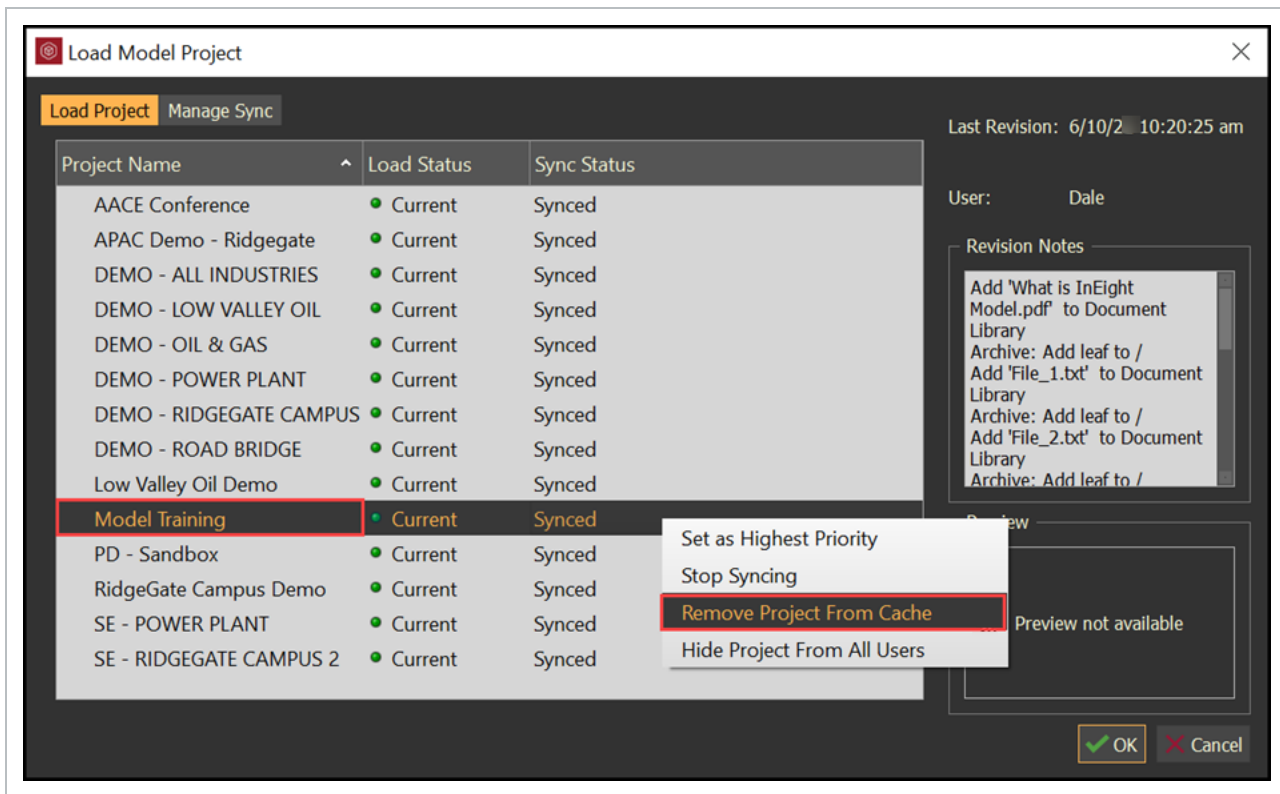

NOTE You must exit InEight Model once a project has been removed before accessing and working in another project.

2.4 CREATE A NEW PROJECT FROM TEMPLATE

In Model (not integrated with InEight Platform) you can create new projects from existing projects as a template. The following items, if existing in the template project, will be created with the new project:

- **Project Structure:**
 - The Project Structure folder structure will be present in the new project.
 - No existing model streams will be present in the new project.
- **Master Presets:**
 - The Master Preset folder structure will be present in the new project.
 - No existing Master Presets will be present in the new project.

- **Styles:**
 - All existing Style Sets with assignments to existing and non-existing tags will be present in the new project.
 - All existing customer Styles will be present in the new project.
- **Tags:**
 - All existing custom tags will be present in the new project.
- **Archive Library:**
 - The Archive Library folder structure will be present in the new project.
 - No existing documents or labels will be present in the new project.

NOTE

InEight Model integrated with InEight Platform does not provide a means to create a Model specific project from a template.

2.4.1 CONSIDERATIONS

- You must have admin permissions to create new projects.
- You can use projects as templates when Model is not integrated with InEight Platform.

2.4.2 STEPS

CREATE A NEW PROJECT FROM TEMPLATE

1. Select File > New Project from Template.

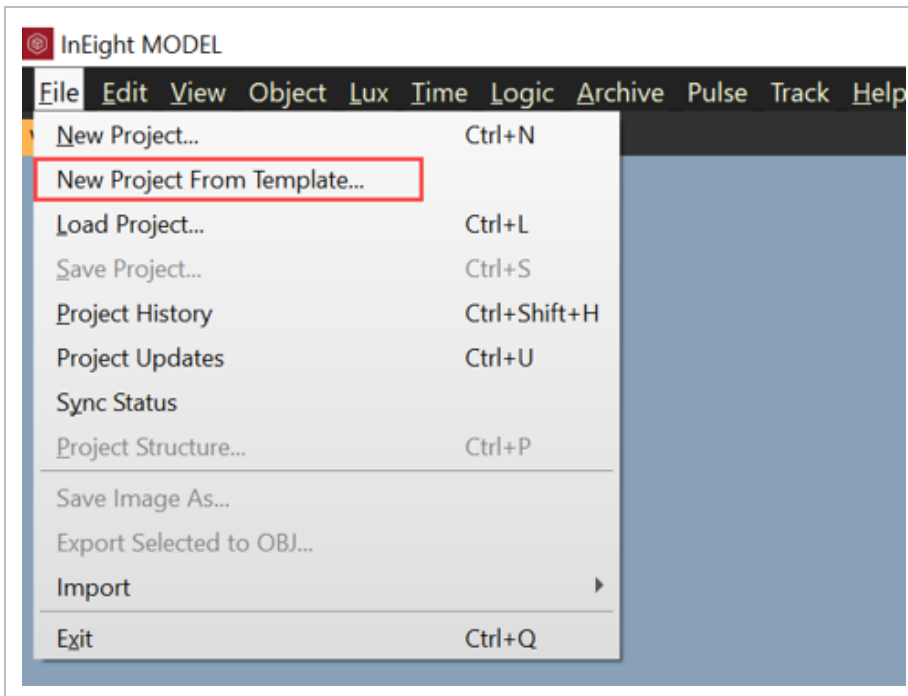

- The New Project dialog box will open

2. Type in the name of the **New Project**.

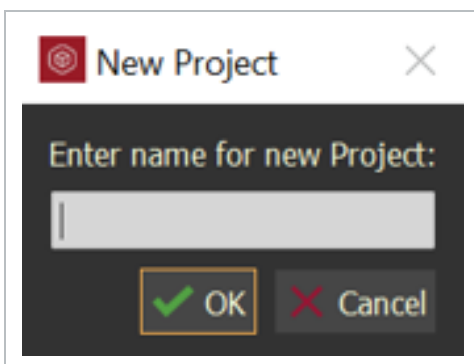

- The Template Project dialog box will open.

3. Select the project to use as the desire **Template**, then click **OK**.



- A validation dialog box will open

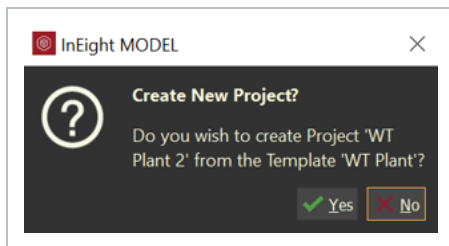

4. Click **Yes**, if the information is correct.

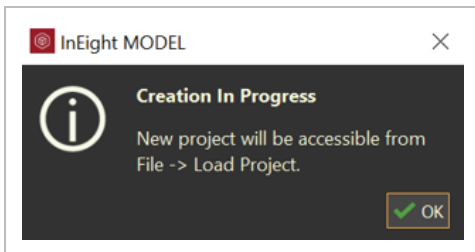

5. Click **OK**, then load your new project

LESSON 2 REVIEW

1. Before you can import a model, you should first create a project.
 - a. True
 - b. False

2. The Manage Sync folder allows you to sync projects to your _____ .
- a. Model Library
 - b. Cache Folder
 - c. Model Stream
 - d. Plugin Folder
-

As a result of this lesson, you can:

- Create and load a project

This page intentionally left blank.

CHAPTER 3 – MODEL STREAMS

3.1 MODEL STREAMS OVERVIEW

A model that is published (imported) into InEight Model is referred to as a Model stream, whether they are exported from a design application or imported from a design file type using plugin tools.

When models are published the following Tag Names are created:

- InEight_Object_Total_Surface_Area
- InEight_Object_Volume

Each plugin tool has standard tags that are included in every published model as shown in the following tables:

Revit

Tag category	Tag value
Model Stream	<model name>
Tag_Level	<level names>
Tag_PhysicalType	Window, Floor, Door, etc.
Revit_Family_Type	<Family Instance names>
Revit_Function	<Walls and Floors>
Material Name - CAD	<face material names>

AutoCAD

Tag category	Tag value
Model Stream	<model name>
ACAD Block	<block names>
ACAD Layer	<layer names>
ACAD Material	<material names>

IFC

Tag category	Tag value
Model Stream	<model name>
IFC Class	<IFC class names>
IFC Layer	<IFC layer names>
IFC Material	<IFC material names>
IFC Name	<IFC name names>

3.2 CONFIG SETTINGS

Config Options gives you the ability to define the parameters, or metadata, that will export along with the geometry, as well as providing some advanced options for applying various transformations.

The **Config Options** column in the **Model Exporter** will report three different states.

1. **Basic** - Indicates the Config Options have not been defined by you. This is the default state of an unpublished Model Stream.
2. **Previous** - Uses the same Config Options as a previous export. This indicates that you're updating an existing Model Stream and not publishing a new one. The settings are pulled from the previous project and are not dependent on the Model Stream being updated from the same computer, or even by the same user.
3. **Custom** - Indicates that the Config Options have been modified during your current session.

TIP Config Options can be configured in bulk by multi-selecting the listed Model Files in the Model Exporter window then clicking within any of the Config Options field that corresponds with your selection.

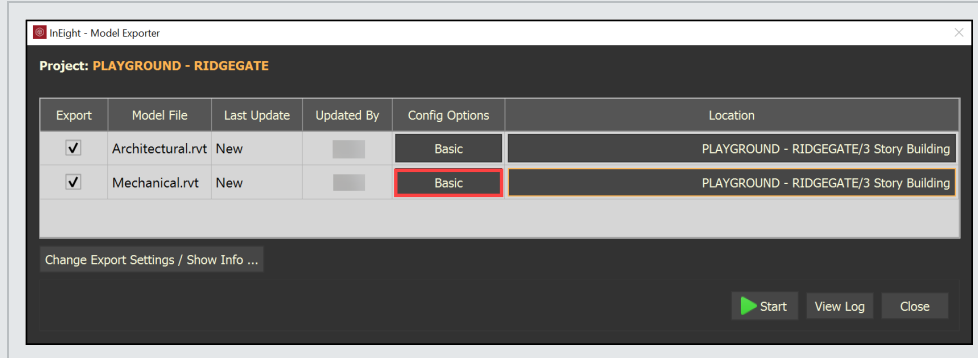

The Parameters tab in the Config Options window allows the user to define what metadata will be exported along with the geometry. The Basic Tags are also displayed along the top of the search bar. Basic Tags will be included in every export regardless of configuration.

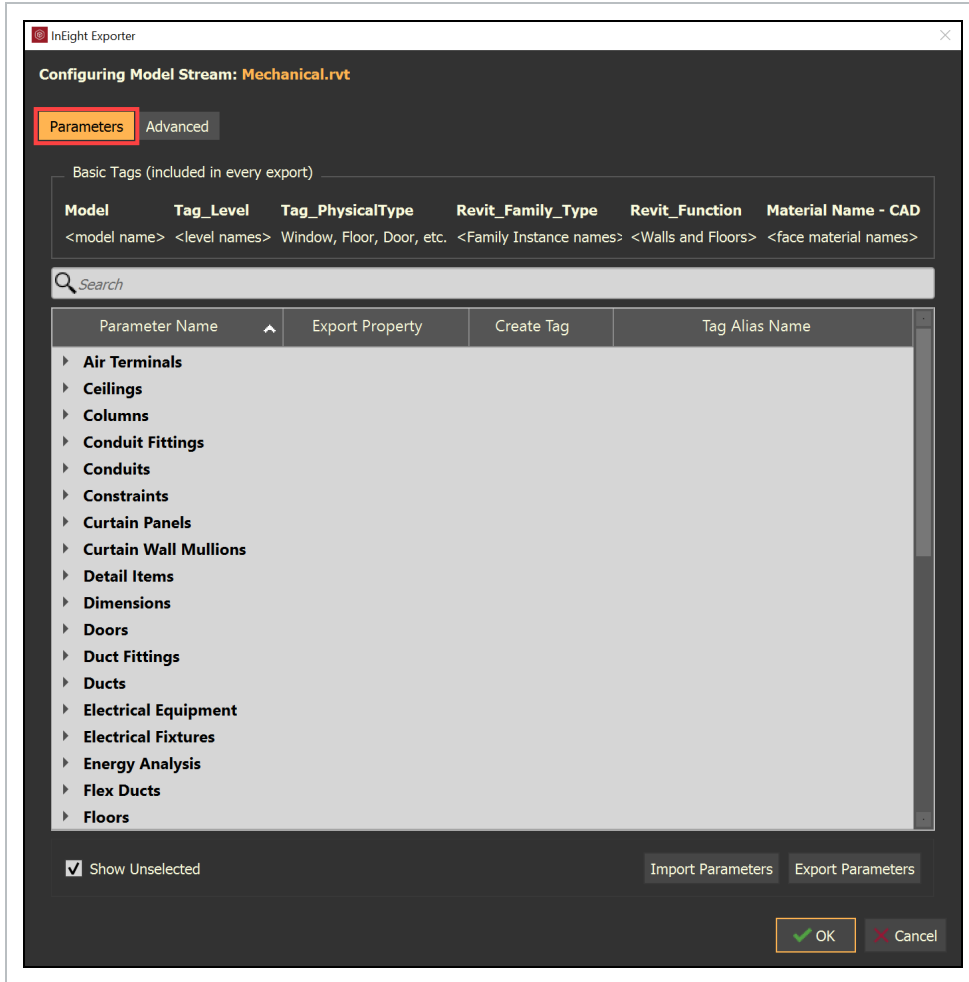

Choose your desired tags and/or properties by expanding a category and checking the box next to a value. In the image below, we see that the Voltage and Wattage for the Electrical Equipment will be exported as a tag and that the Length and Volume for Structural Columns will be exported as properties. Additionally, clicking in the **Click to rename...** field in the Tag Alias Name column, the Length of the Structural Columns has been renamed to Cut Length. Renaming these values is a quick and easy way to achieve consistency when pulling geometry and metadata from files authored by various different organizations that may be using different values to represent the same data.

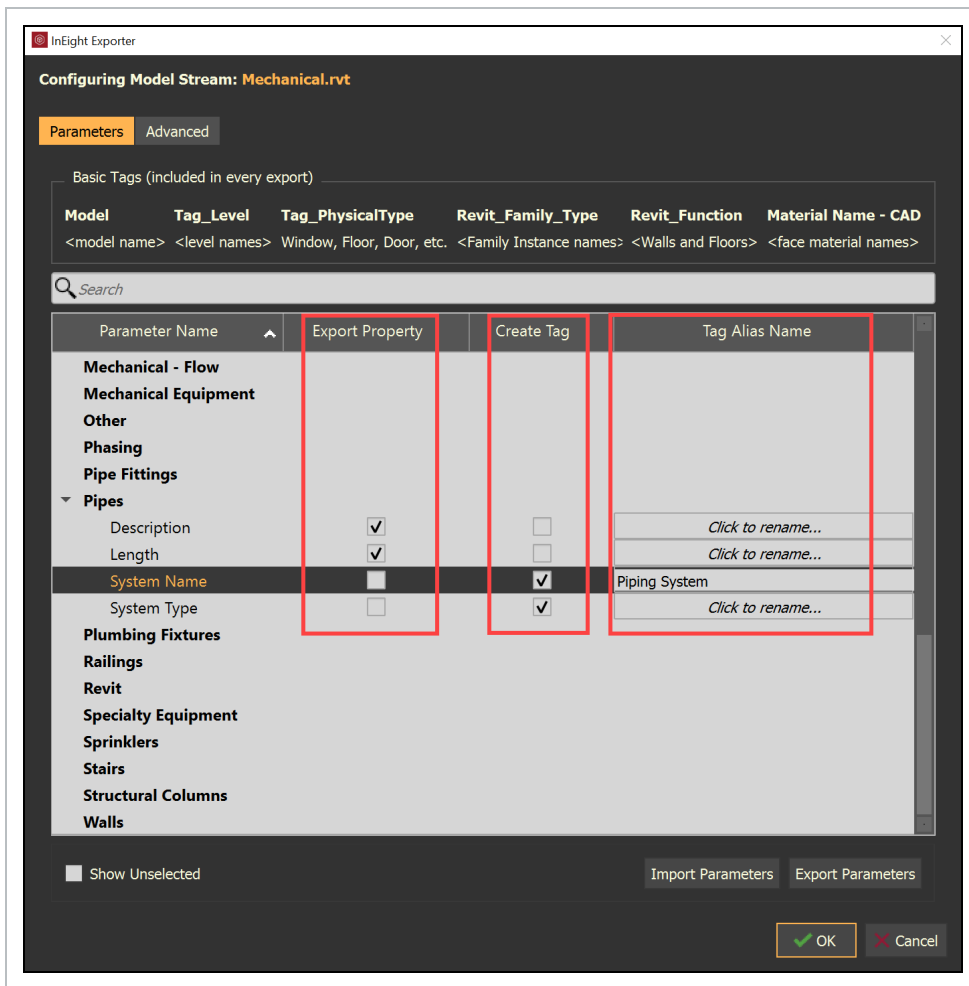

With the **Show Unselected** box checked (in the bottom left corner), all available parameters will be displayed. With the **Show Unselected** box un-checked, only the selected parameters will be displayed, this allows the user to easily view the current configuration.

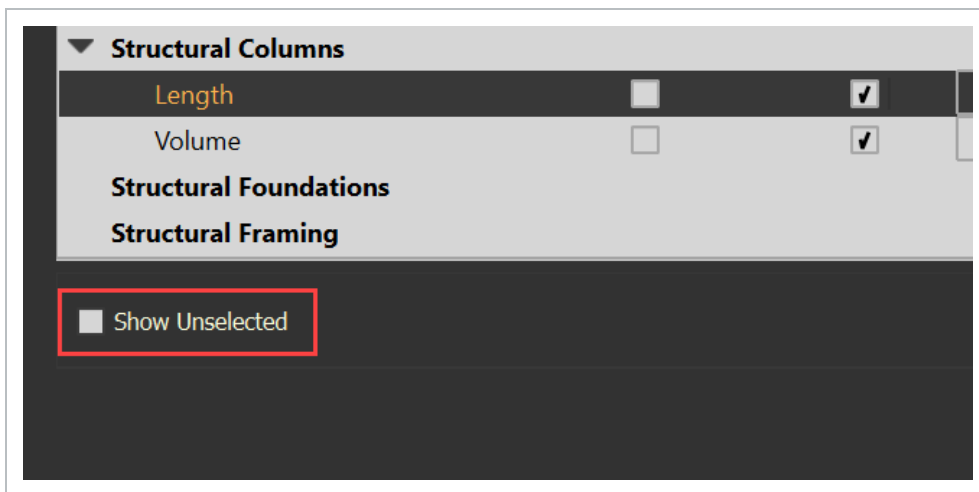

Use the **Import Parameters** and **Exporter Parameters** buttons to save your configuration to a local file or to import a previously saved configuration.

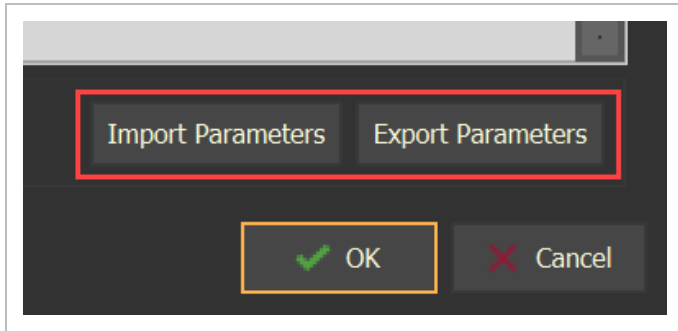

The **Advanced** tab allows Scale, Rotate, and Translate (move) options upon export. Settings configured in the Advanced Options are retained in future model updates.

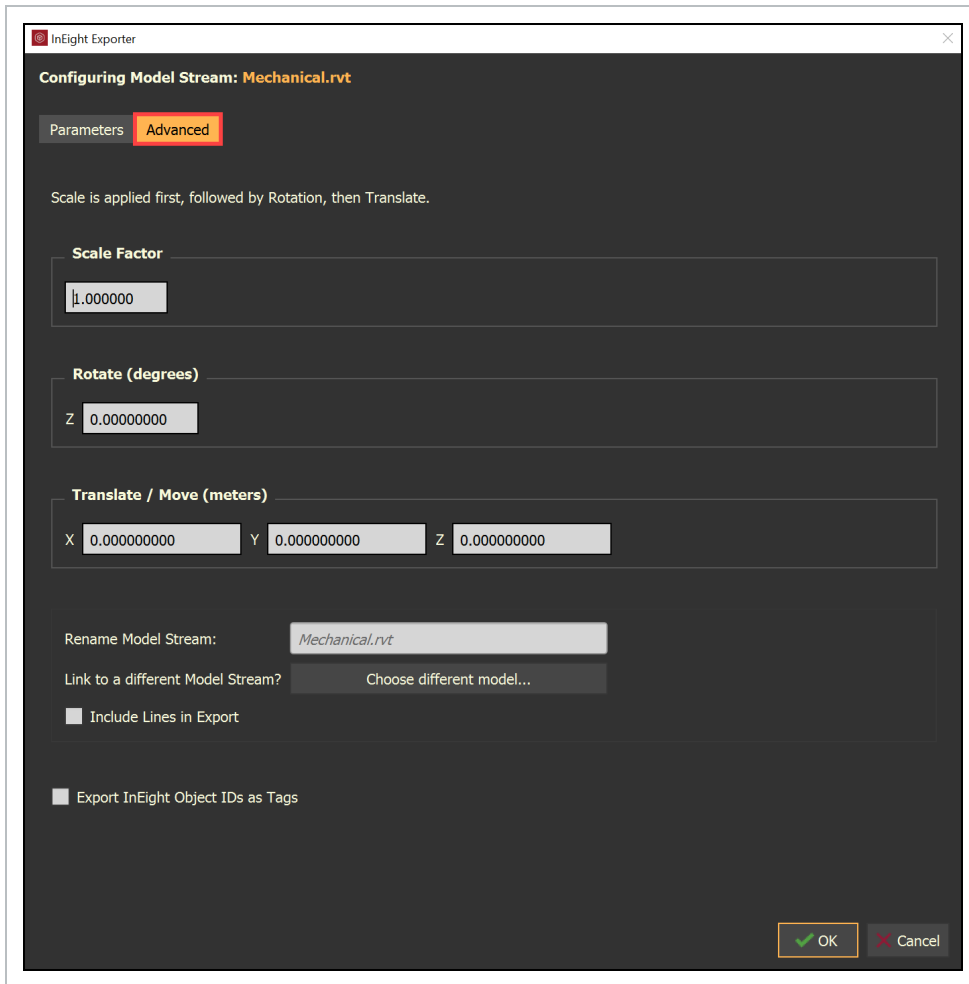

To change the name of the Model Stream simply click in the **Rename Model Stream** field and enter the desired name.

If desired, check the **Include Lines in Export** box to include 2D and 3D line work.

- **Scale, Rotate and Translate / Move** provides a way to adjust the model as needed up export
- **Rename Model Stream** provides a way to rename the model file upon export
 - The new name will appear in the Objects panel and as a value within the Tag Category "Model"
- **Include Lines in Export** provides a way to include 2D and 3D line work upon export

3.2.0.1 OVERVIEW - CONFIGURING MODEL STREAMS PARAMETERS TAB

Item		Description
1	Parameter Name	Displays the Property Set Name and the Property Name of the metadata.
2	Export Property	Will export the Property Name with the existing value for each model object.
3	Create Tag	Will utilize the Property Name to create a Tag name with the existing value for each model object.
4	Tag Alias Name	Provides the capability to control what the Tag name is during the export of the model.
5	Export Parameters	Once the desired "Export Property", "Create Tag," and "Tag Alias Name" columns have been selected and filled out, then select Export Parameters to save these settings to use on similar models.
6	Import Parameters	If previous parameters have been exported, then select Import Parameters to populate Parameters.

3.2 STEP BY STEP 1 – CONFIG SETTINGS - PARAMETERS

1. Within the Model Exporter window, select **Basic**.

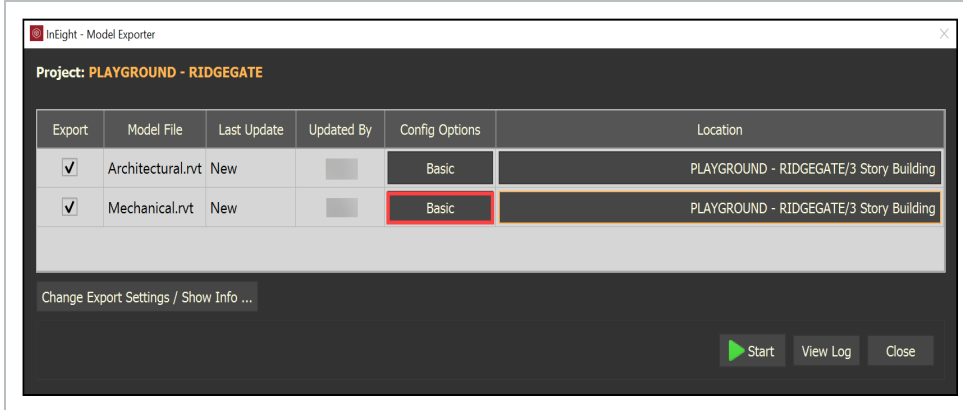

- The Config Options window opens with the initial focus on parameters

NOTE

The Parameters tab in the Config Options window allows the user to define what metadata will be exported along with the geometry.

The Basic Tags are also displayed along the top of the search bar. Basic Tags will be included in every export regardless of configuration.

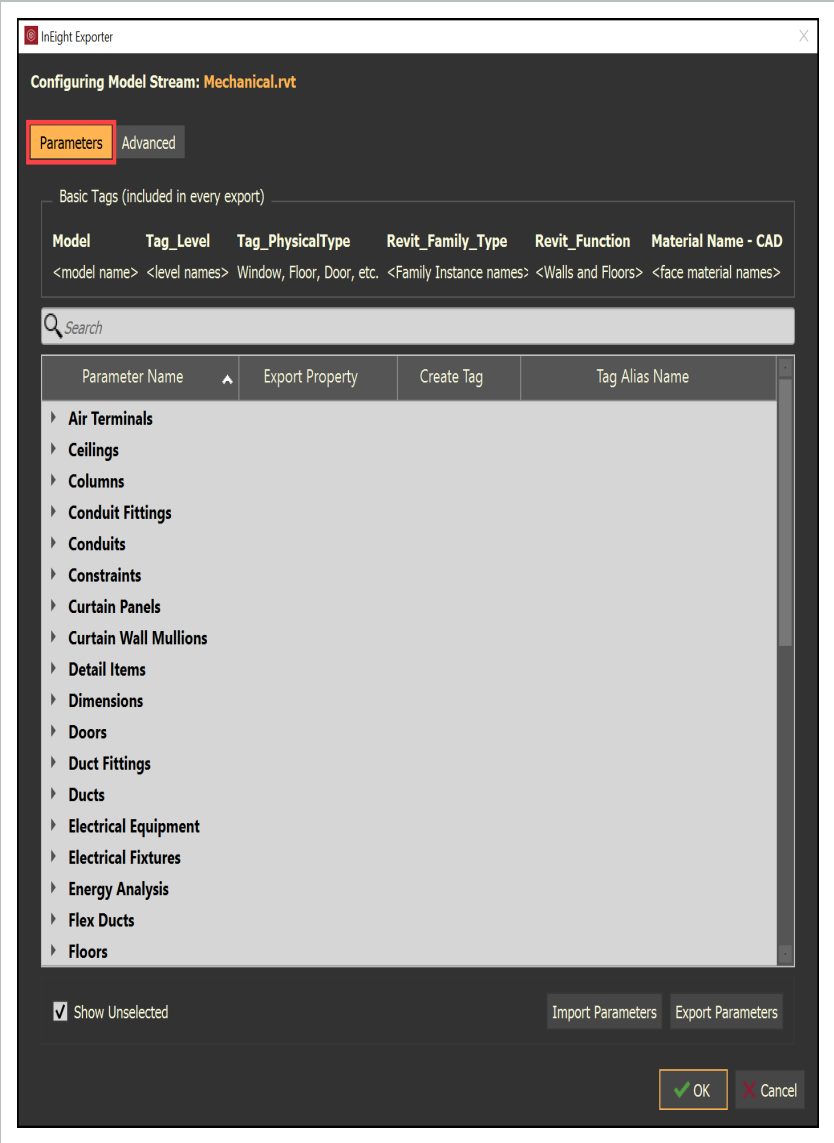

2. Select the desired tags and/or properties to export with the Model Stream.

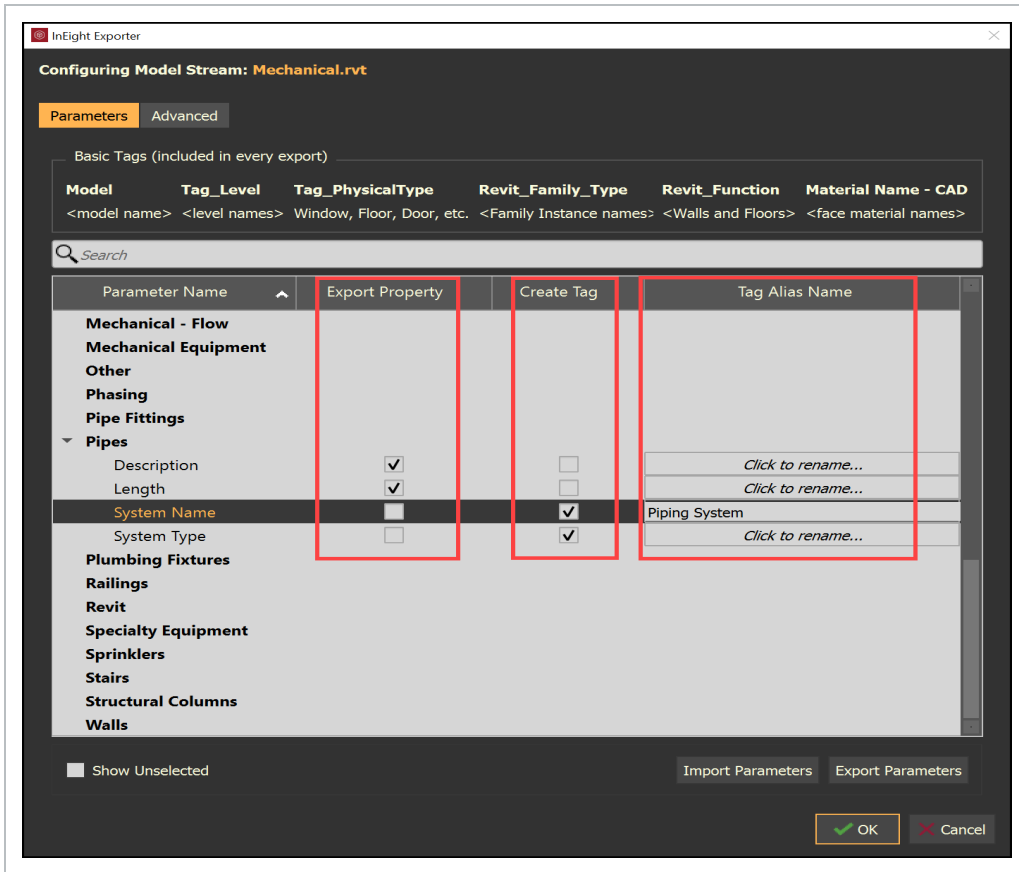

- **Create Tag** will create a tag category and tag value metadata for the relative model objects
 - Column Location Mark, Length and Volume will be the tag categories within InEight Model
- **Export Property** will create property category and property value metadata for the relative model objects
 - Fire Rating and Manufacturer will be the Property Categories within InEight Model
- **Tag Alias name** will rename the Category name

- Length will be renamed to Cut Length during the export
- Renaming these values is a quick and easy way to achieve consistency when pulling geometry and metadata from files authorized by different organizations that may be using different values to represent the same data

3. Select or unselect **Show Unselected**.

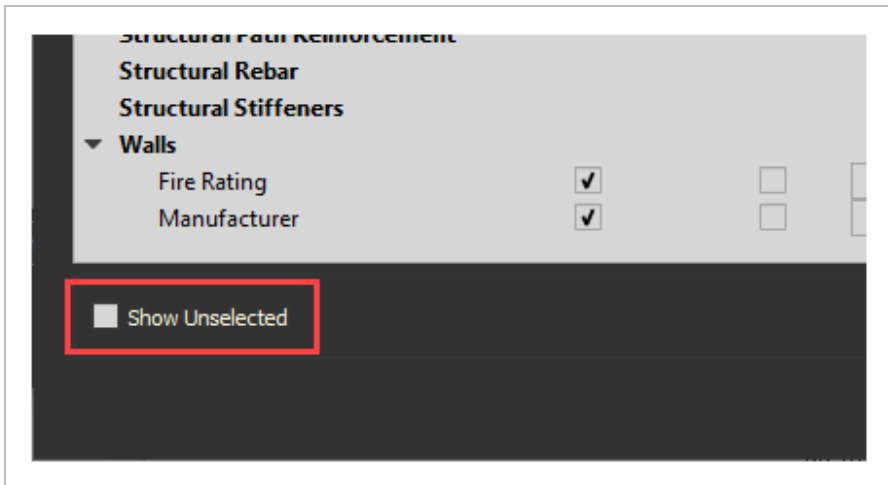

4. Select **Import Parameters** or **Export Parameters**.

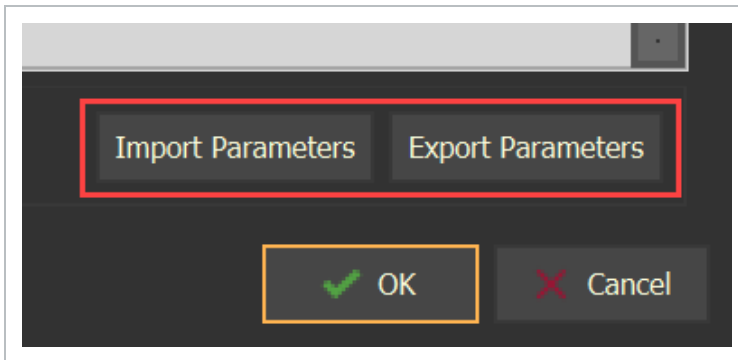

5. Select **OK** when you have completed.

3.2 STEP BY STEP 2 – CONFIG SETTINGS - SCALE / ROTATE / XYZ

1. Select the **Advanced** tab from the Model Exporter.

- The Advanced tab shows options to manipulate the model.
- If the Scale Factor, Rotate, and/or the XYZ are needed to adjust the model then they are applied in the displayed order from top to bottom (Scale Factor > Rotate > XYZ).

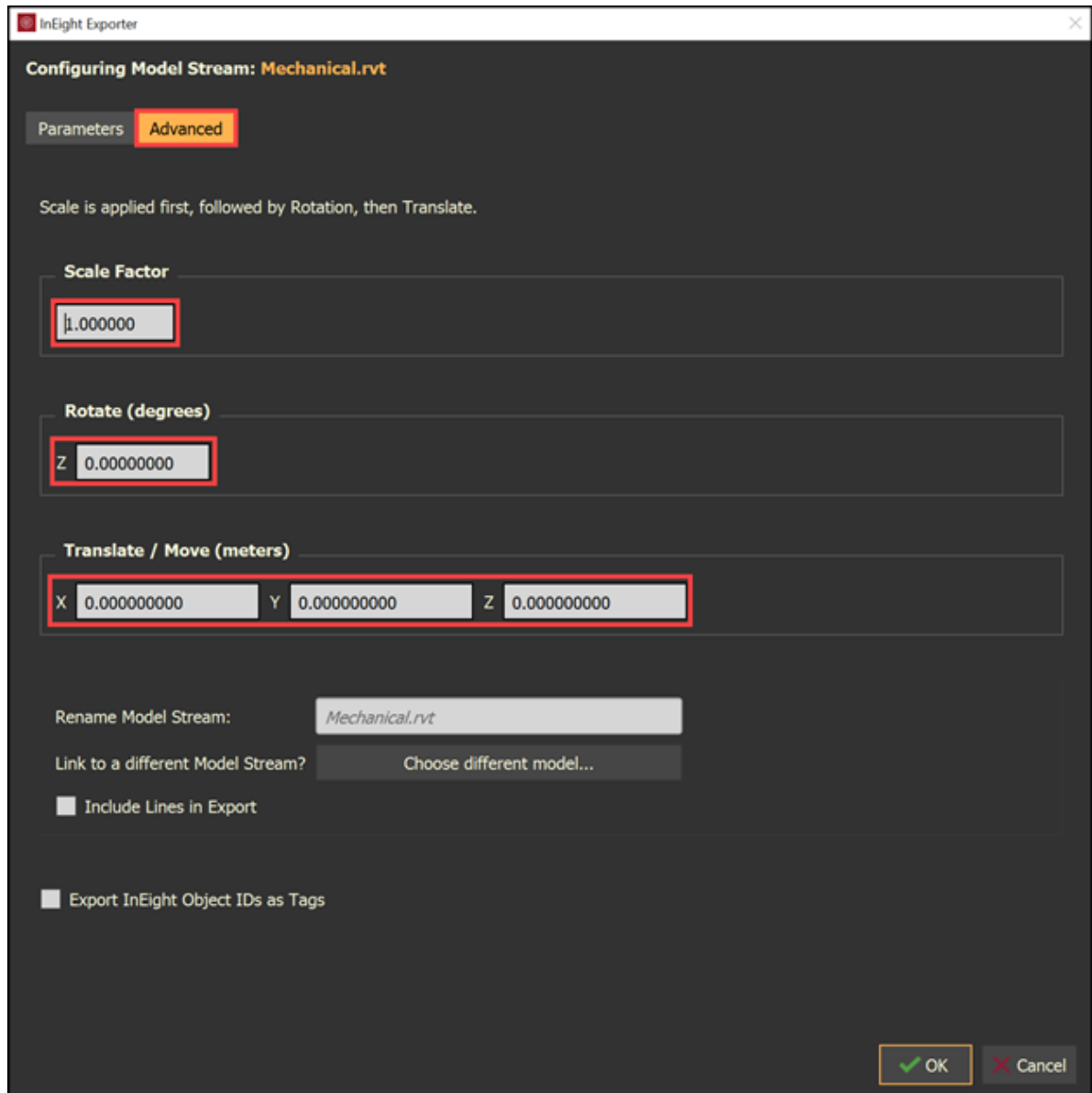

2. Add a scale factor to adjust the scale of the model as needed.

3. Add a Rotation angle by degrees as needed.
4. Add X, Y, and Z coordinates as needed.
5. Click **OK** when done with Config Options.

3.2 STEP BY STEP 3 – CONFIG SETTINGS - RENAME MODEL STREAM

1. Select the **Advanced** tab from the Model Exporter.
 - The model file name might change if the designer or architect puts a revision status or date on the file name with every version.
 - The Rename Model Stream lets you rename the model stream without changing the model file name and provides a consistent model stream name for all end users to

access.

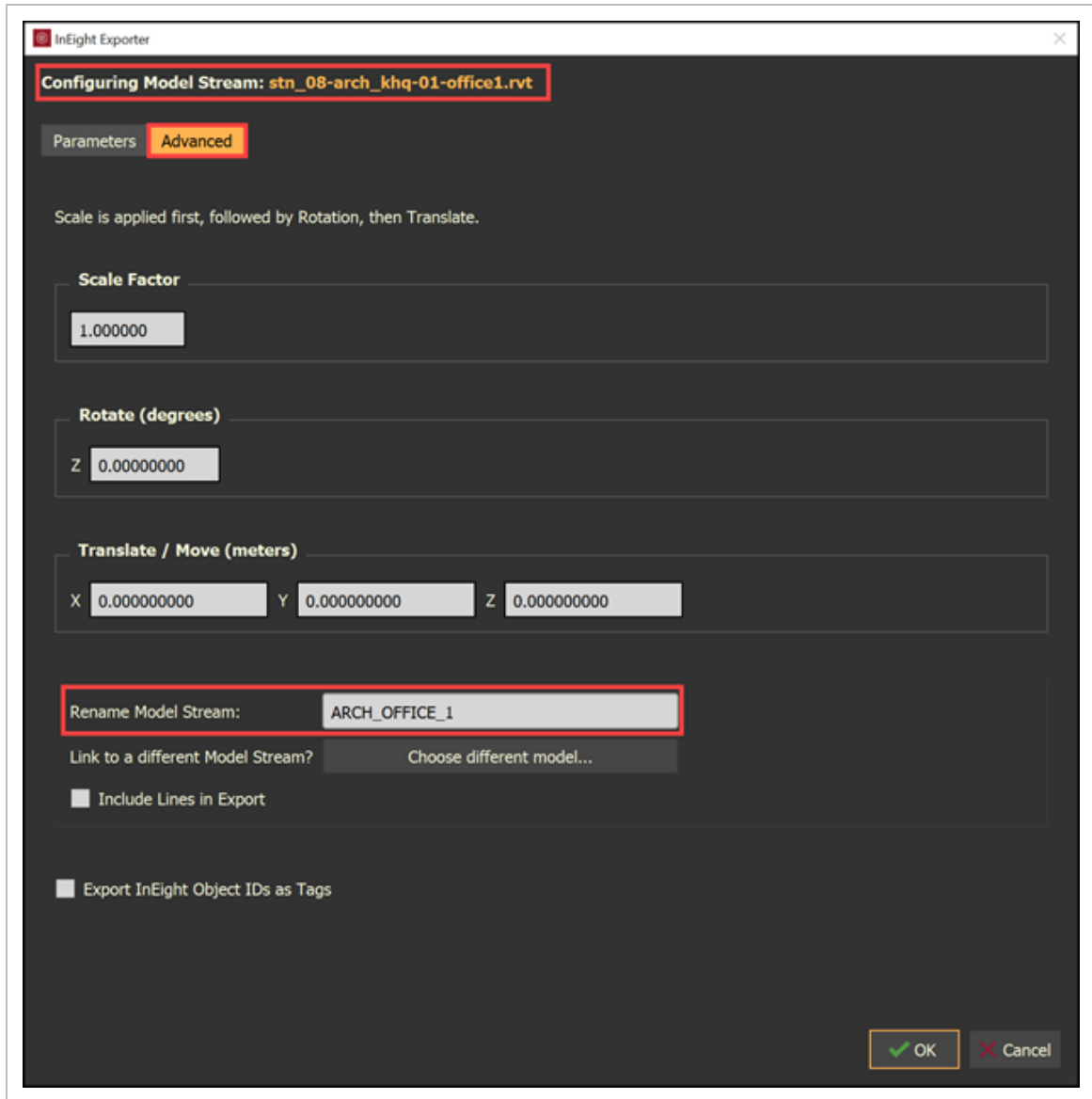

2. Type a Model Stream Name.
3. Click **OK** when done with Config Options
 - The Project Structure shows the Renamed Model Stream and, in the Revision History, shows the Model Stream Source File name.

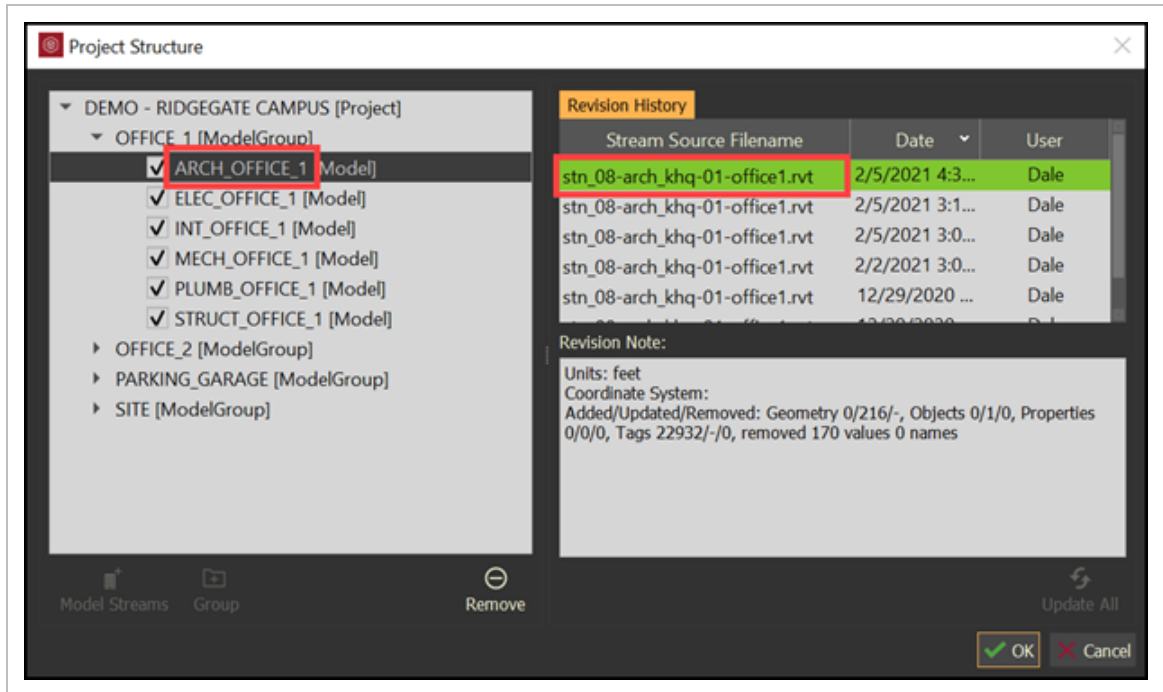

- The Tags and Objects panel shows the Renamed Model Stream in the Object tab for the project team to use throughout the project.

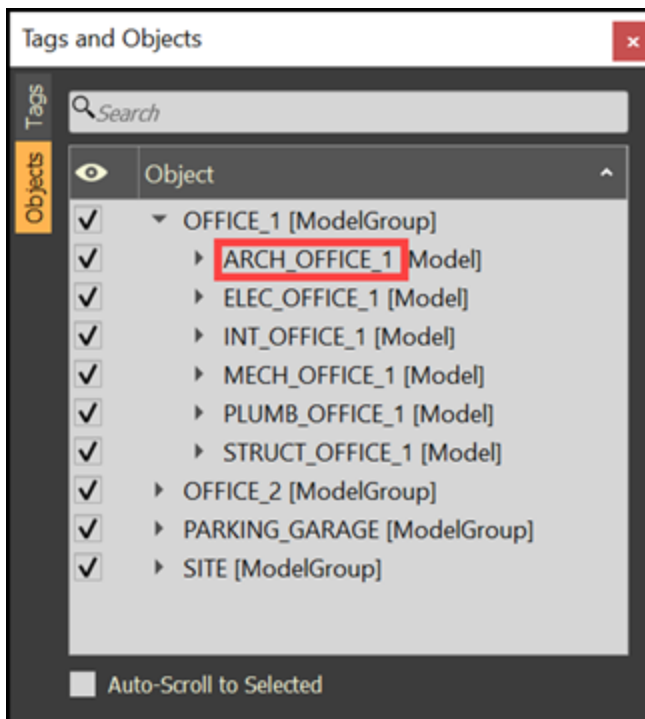

3.2 STEP BY STEP 4 – CONFIG SETTINGS - LINK TO A DIFFERENT MODEL STREAM

1. In the Model Exporter, you might see a message of “Resolve Model Conflict...**” in the Location column. This is a result of multiple models loaded with similar names. Click **Resolve Model Conflict...****

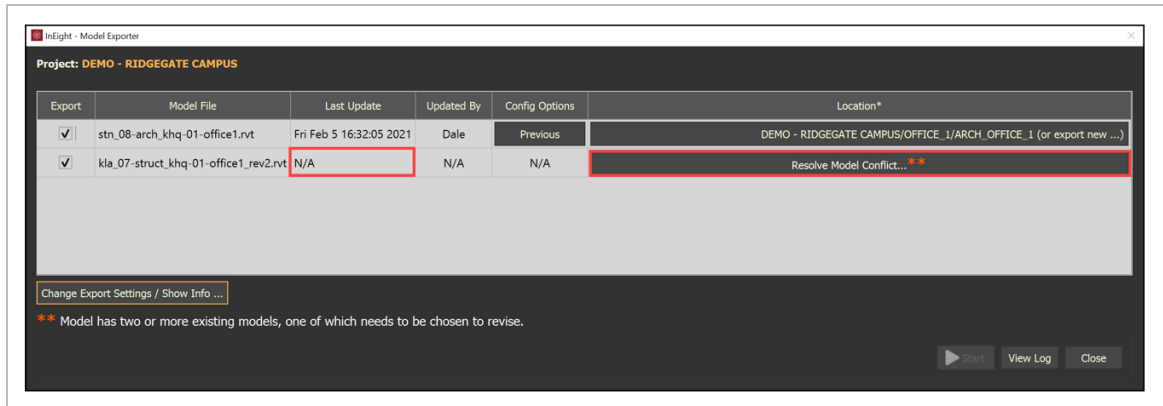

2. If the model stream is not shown, then click **Export as New...**

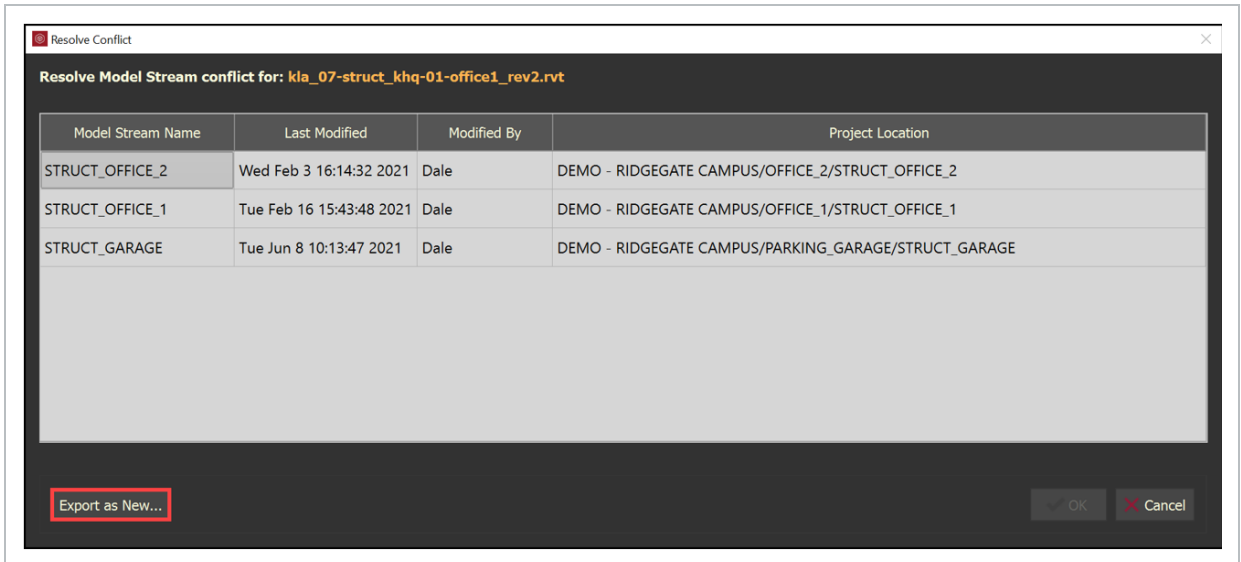

3. Choose a location.

- You can only select the parent level or a group level location.

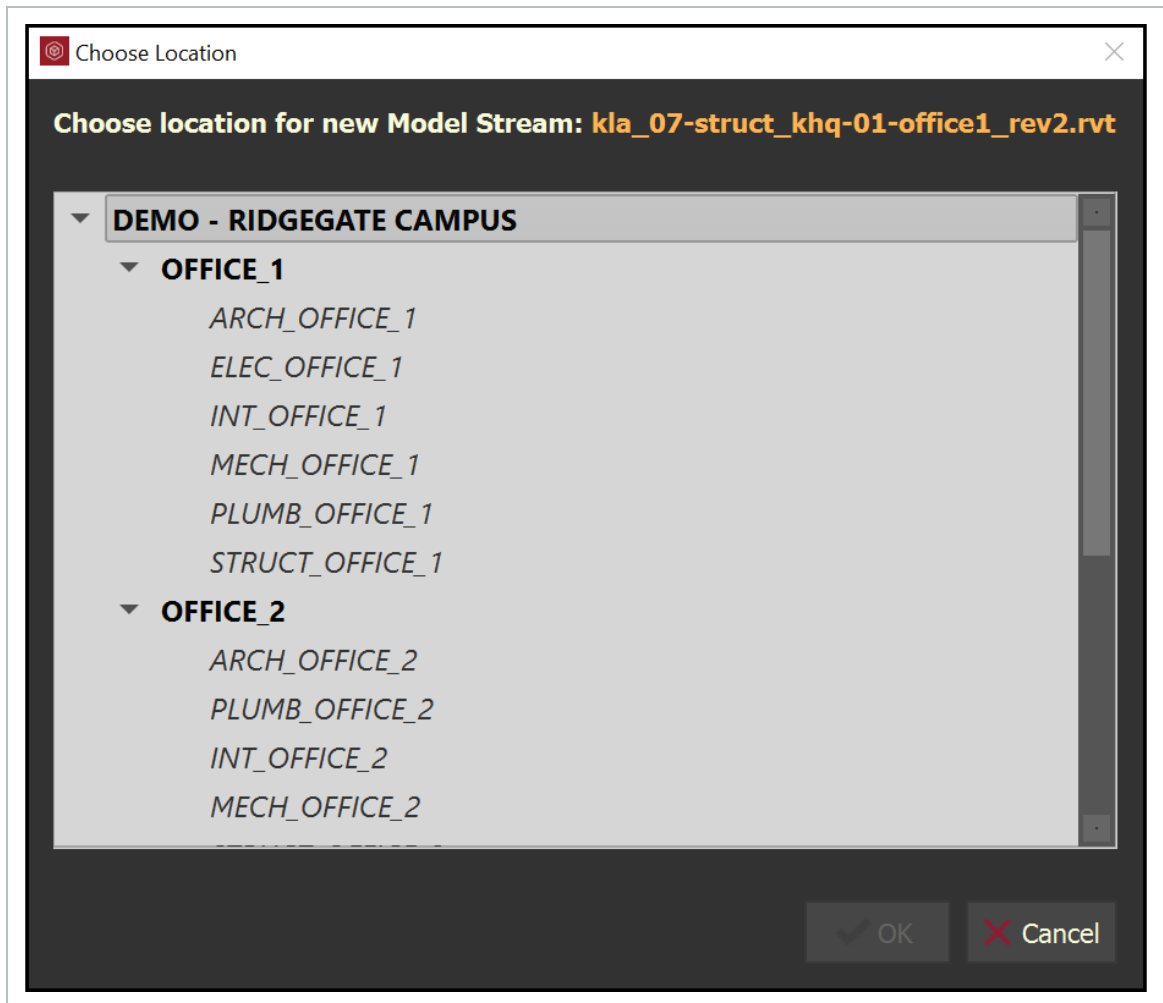

4. Click **OK** to close the Choose Location dialog box.

5. Click **OK** to close the Resolve Conflict dialog box.

6. Click **Basic** in the Config Options column.

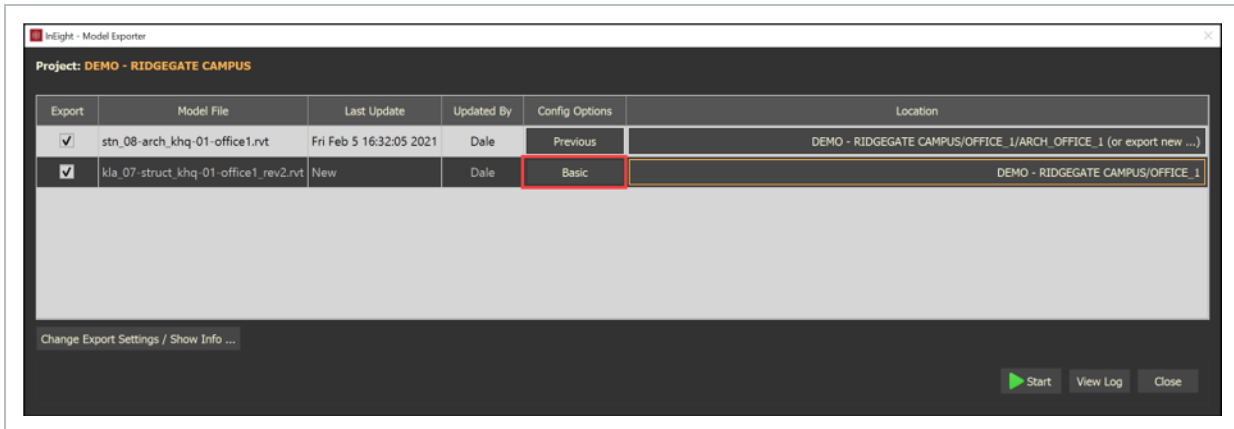

7. Click the **Advanced** tab.

8. Click **Choose different model...**

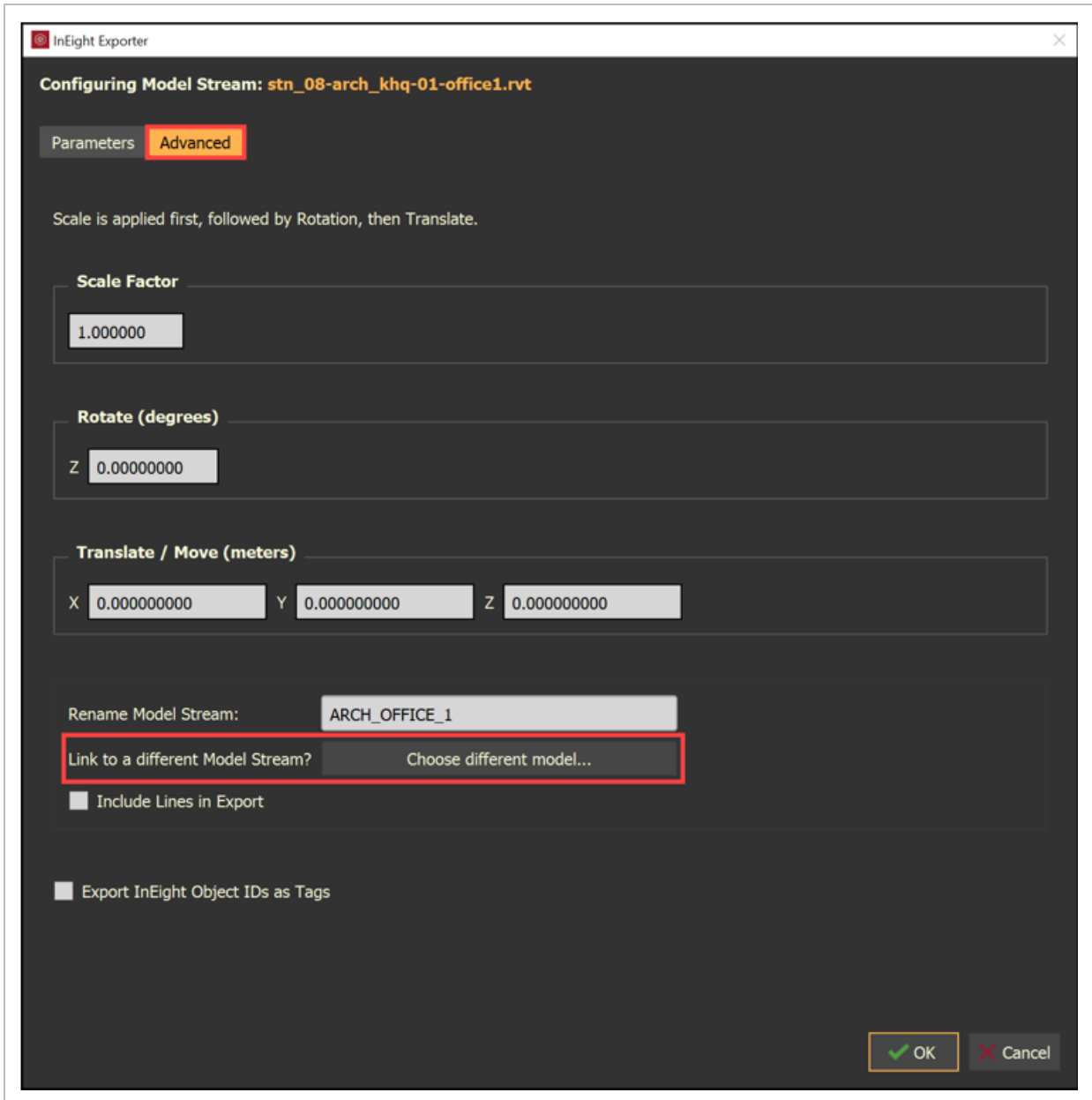

9. In the Choose Location dialog box, select a Model Stream to link to.

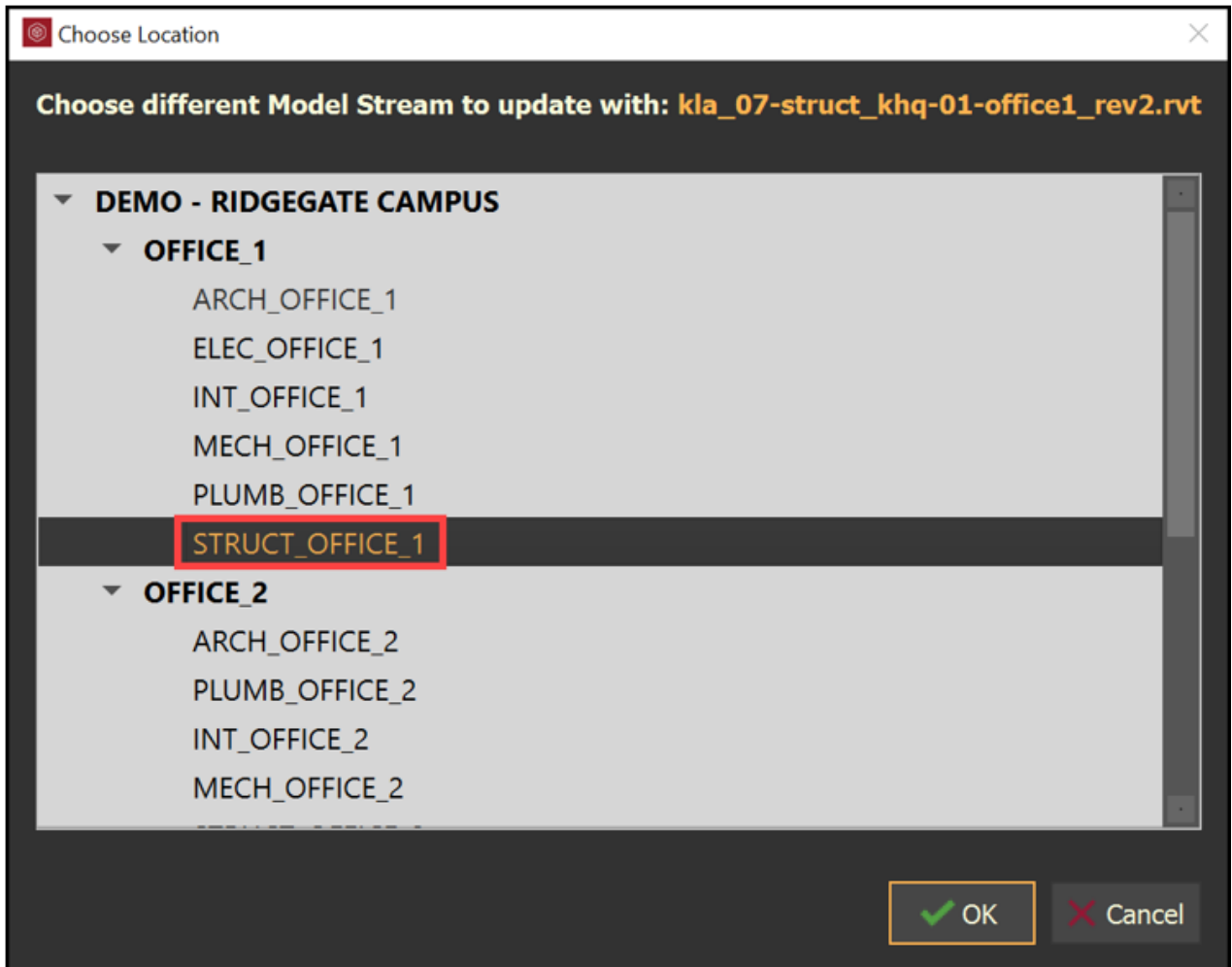

10. Click **OK** when done with Config Options.

3.3 EXPORT SETTINGS

When available for plugin, Export Settings lets you configure the model location options and the model visibility options.

3.3.0.1 EXPORT SETTINGS OPTIONS:

Revit Location refers to the coordinate systems contained within the Revit Project and can be defined three ways

- **Ask on Export** - The Model Exporter will prompt the user to select the appropriate coordinate system during export
- **Use Revit Project Location** - Uses the active project location
- **Use None** - Resets project location to default values

Export Selected will require the user to have an active selection prior to initializing the Model Exporter and will only export selected objects

Visibility tells the Model Exporter which geometry to include in the export

- **Export Visible** - Exports all visible content within the 3D view
- **Export Visible + Room Volumes** - Exports all visible content within the 3D view plus room volumes
- **Export All** - Exports all geometry found within the Revit project, even if it's hidden in the active 3D view

Info displays some basic information about your current session

- **InEight Connection** - Displays the current status of the Model Exporter's communication with InEight Model
 - **Connected - Online** - Connection is established to the server
- **Disconnected - Offline** - Not connected to the server. Check your Internet connection or login to your project within InEight Model
- **Logged-in as** - The currently logged in user
- **Cache Location** - The path of the InEightModel_Cache folder

3.3.1 STEPS

EXPORT SETTINGS

1. In the Model Exporter window, select **Change Export Settings / Show Info ...** to open the Export Settings window.

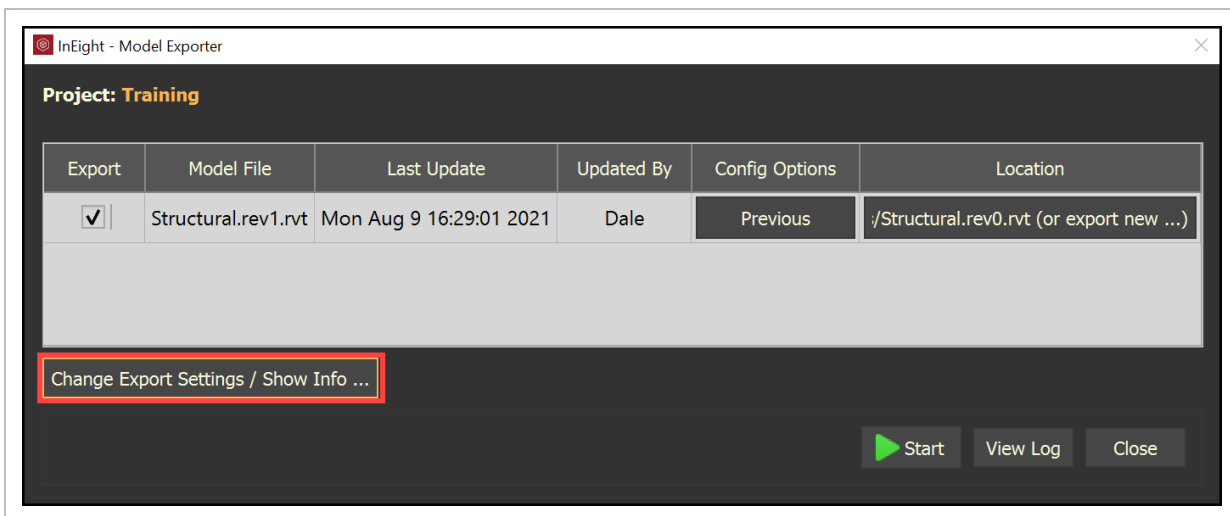

- The Export Settings window opens

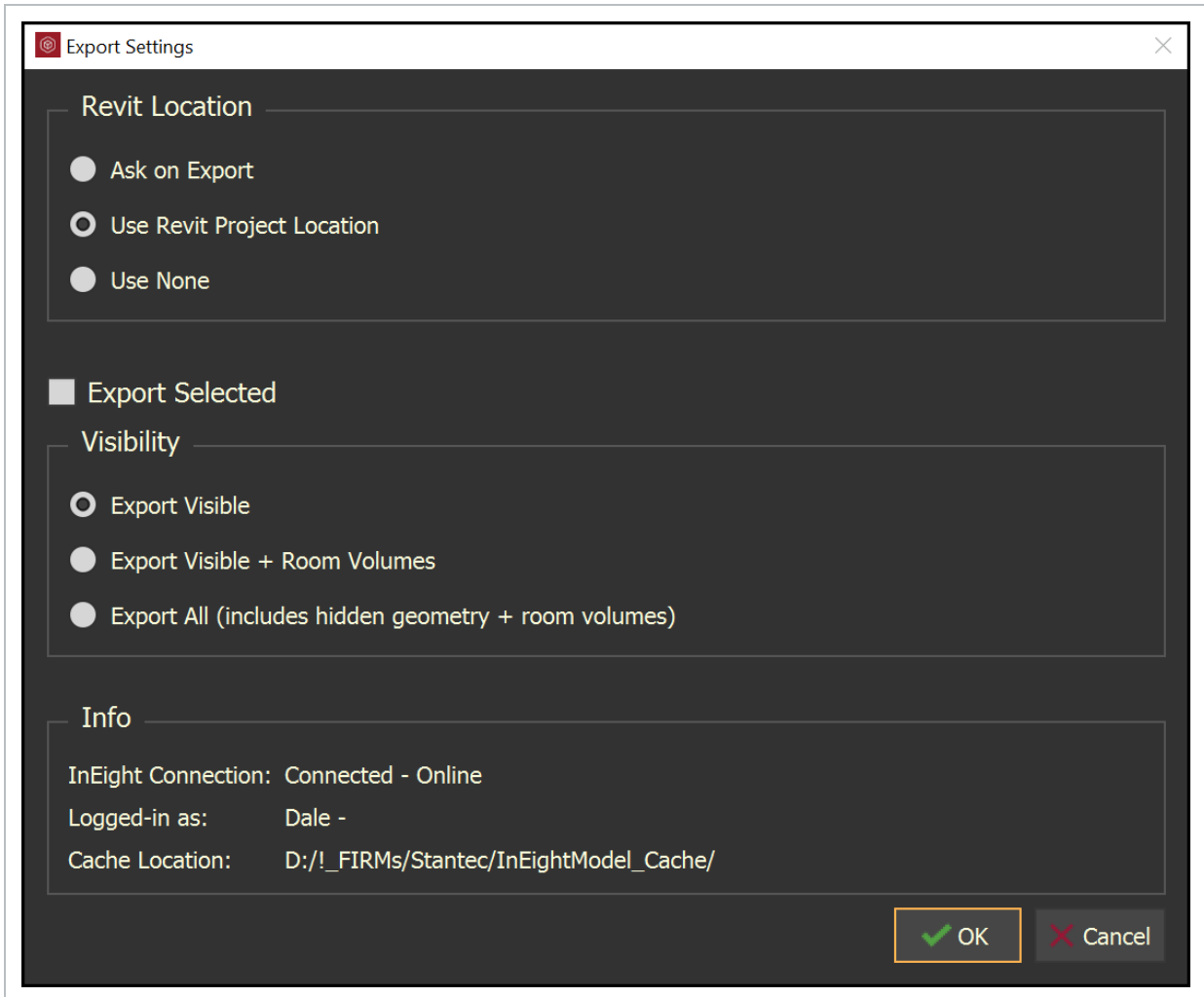

2. Complete your changes, and then click **OK**.

3.4 MODEL REVISIONS

Model revisions might occur during project execution.

3.4.0.1 MODEL WITH SAME NAME

Follow the same process of the initial exporting from AutoCAD or Revit or importing an IFC file.

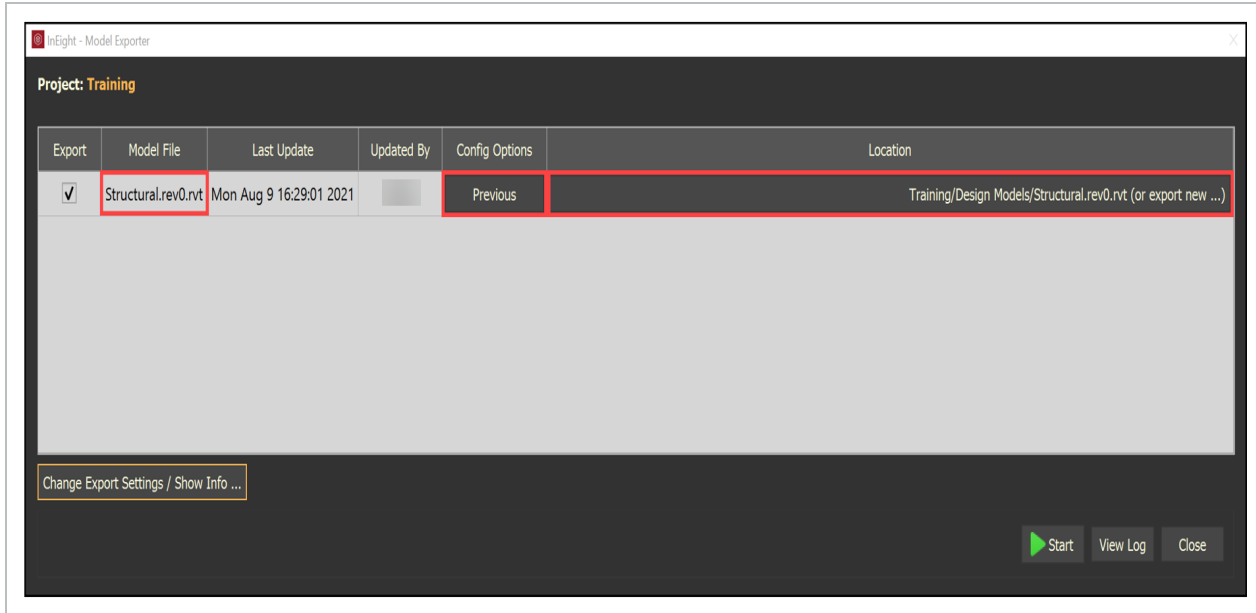

Notice the following parameters while updating the model.

- The **Model file** is the same file name that you have opened to update.
- The **Location** is populated from the previous selection and lets you export as a new model.
- The **Config Options** use the previous settings.

3.4.0.2 MODEL WITH A REVISED NAME

Follow the same procedure of the initial exporting from AutoCAD or Revit or importing an IFC file.

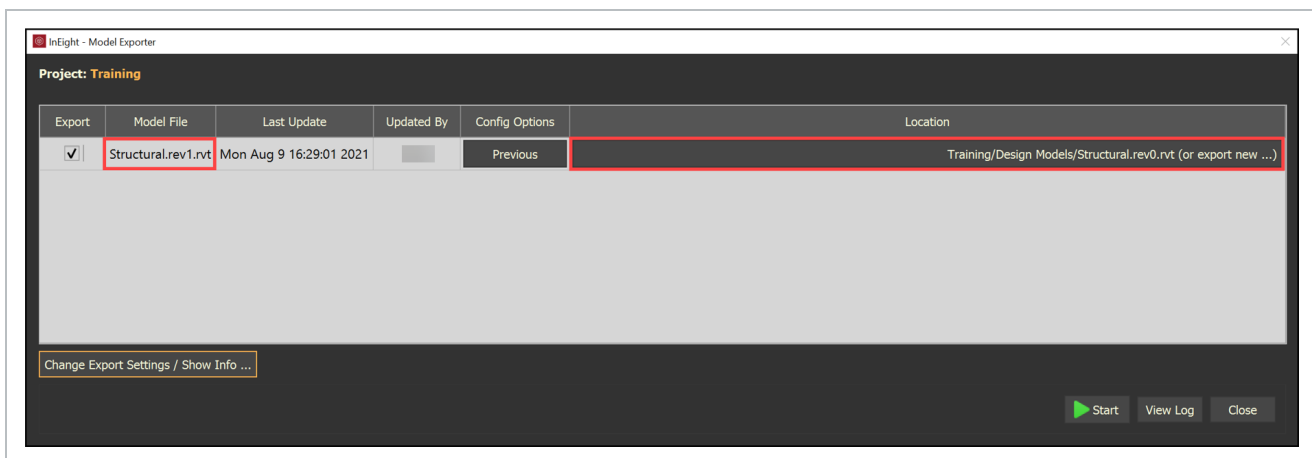

Notice the Model file has .rev2 added to it, different from the initial file name.

NOTE The system puts the revised model stream in the previously selected location.

3.4 STEP BY STEP 1 – RESOLVE MODEL CONFLICT

1. Select Resolve Model Conflict...

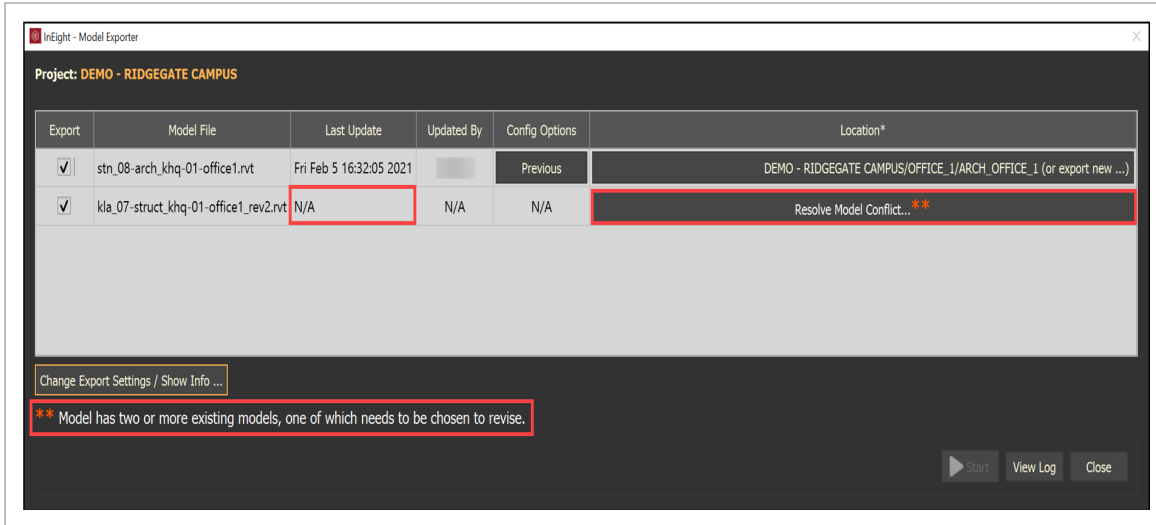

- The Resolve Conflict window opens

2. Select the applicable model stream to be revised.

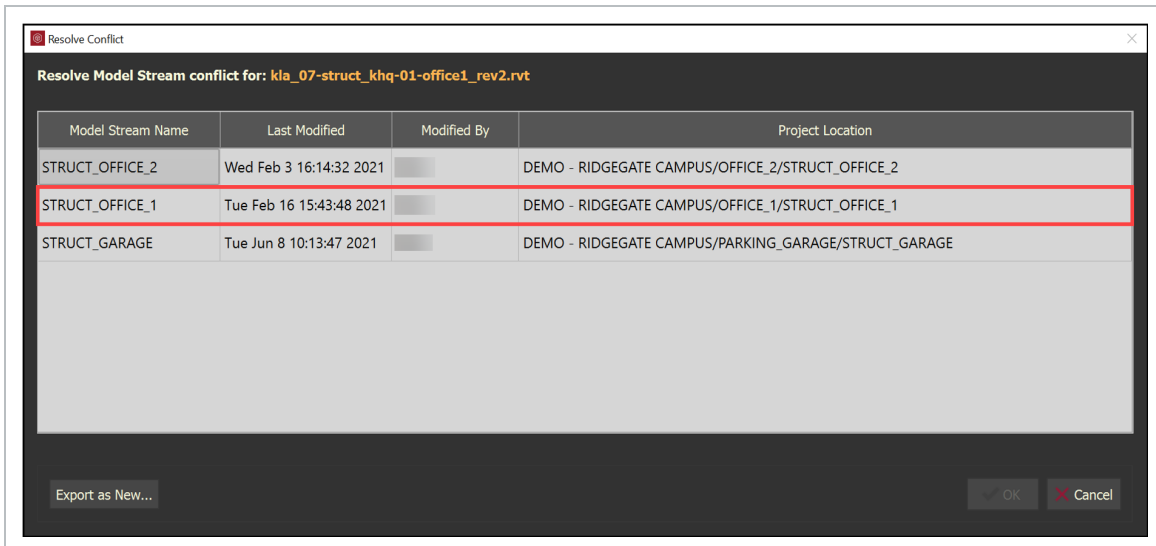

3. Select **Export as New...** if this is a new Model Stream.

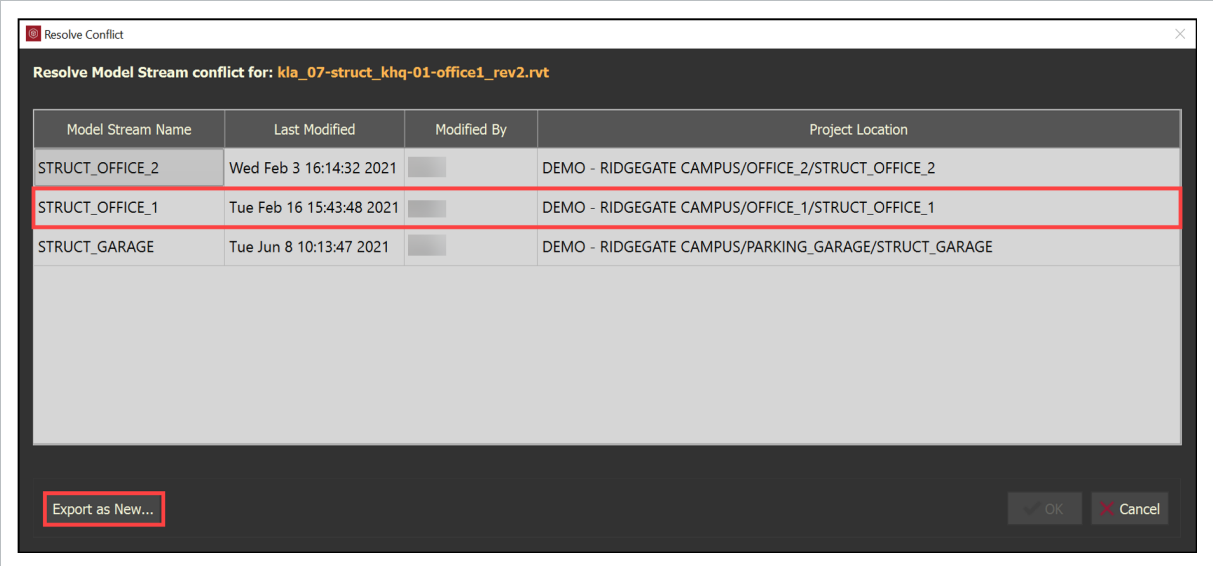

- The Choose Location window opens.

4. Select the preferred location in the Project Structure.

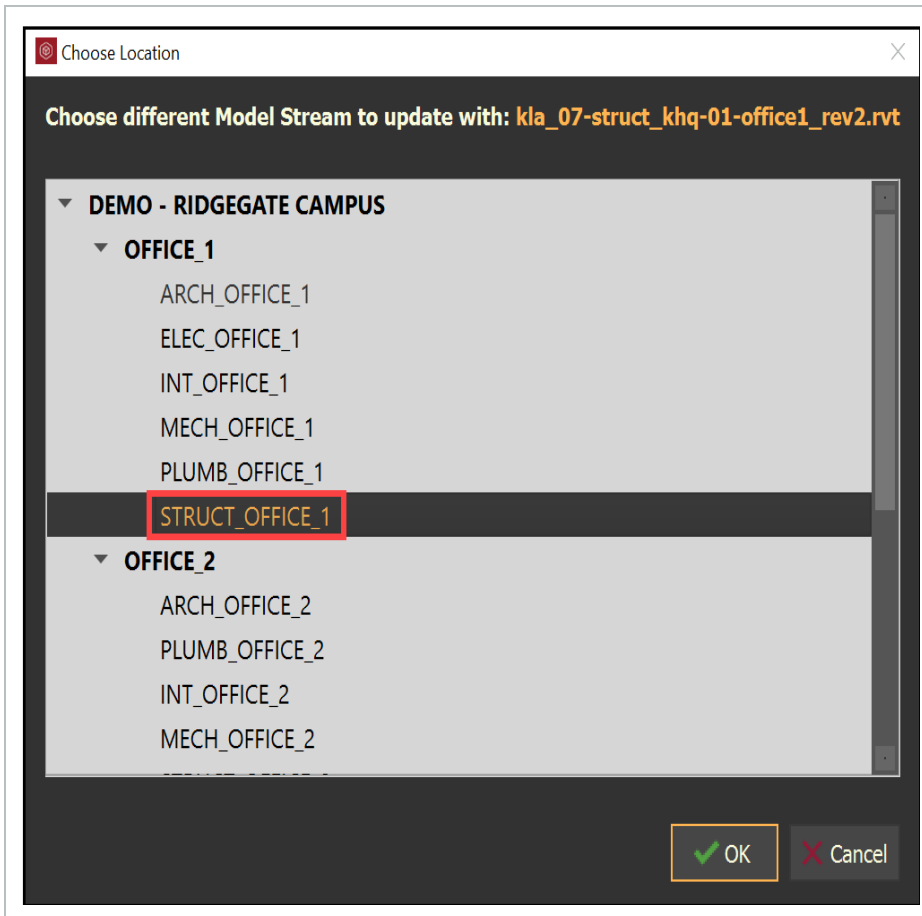

5. Select OK to complete.

NOTE

When exporting a model with a similar name to more than one model, the system shows **Resolve Model Conflict...** in the location column.

3.5 ANALYZE MODEL CHANGES

Analyze Model Changes provides the ability to compare models over time. The comparison is not limited to two models, the comparison is triggered off two calendar dates, which could include 2 or more model stream revisions.

The comparison will provide which model stream was compared, how many objects were added, how many objects we updated, and how many objects were removed.

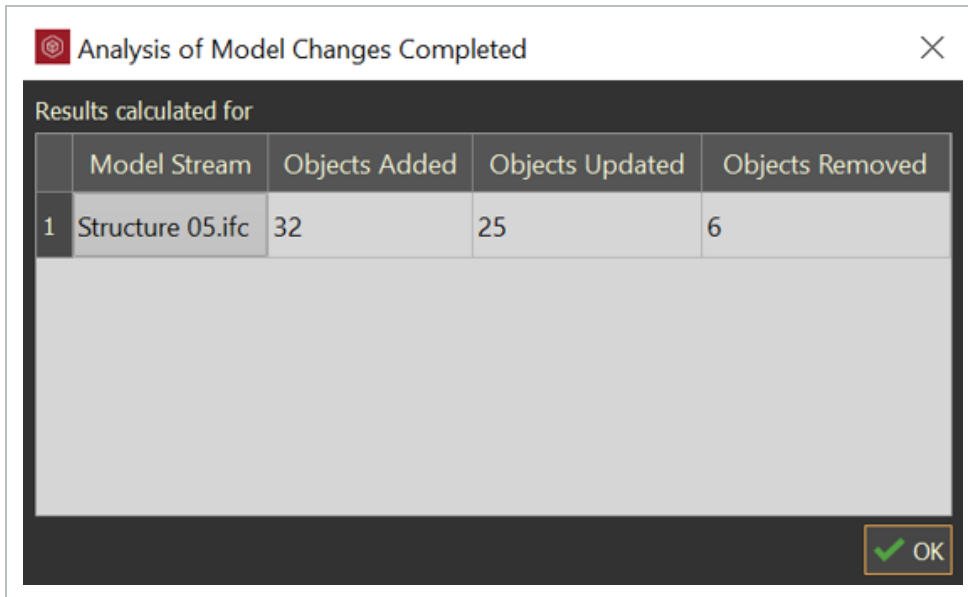

Analysis of Model Changes Completed

Results calculated for

	Model Stream	Objects Added	Objects Updated	Objects Removed
1	Structure 05.ifc	32	25	6

OK

The comparison will also create a new Tag Category named Tag_User with two tag values: *(date range) (Model Stream Name)_added* and *(date range) (Model Stream Name)_updated*.

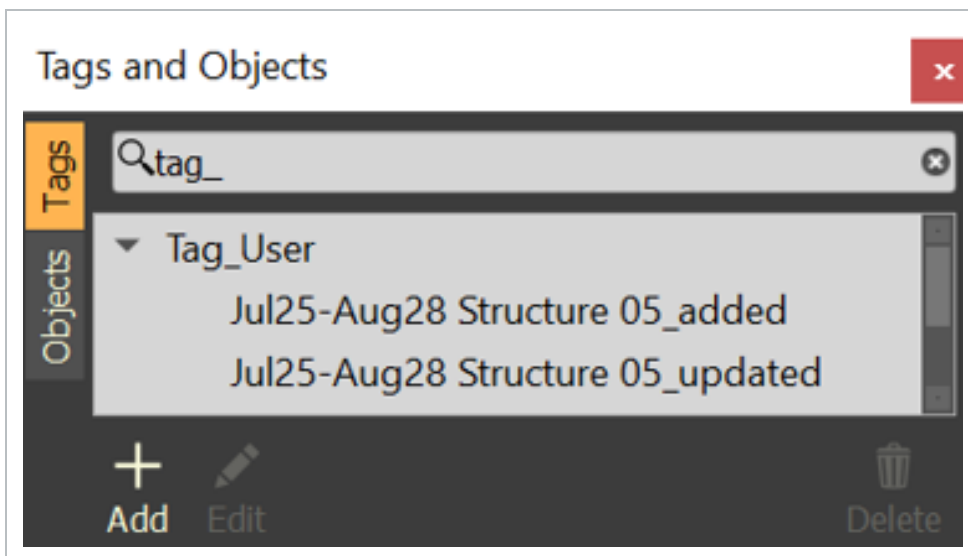

Also, a Style Set is created within the Styling Panel with the name *(date range) (Model Stream Name)*

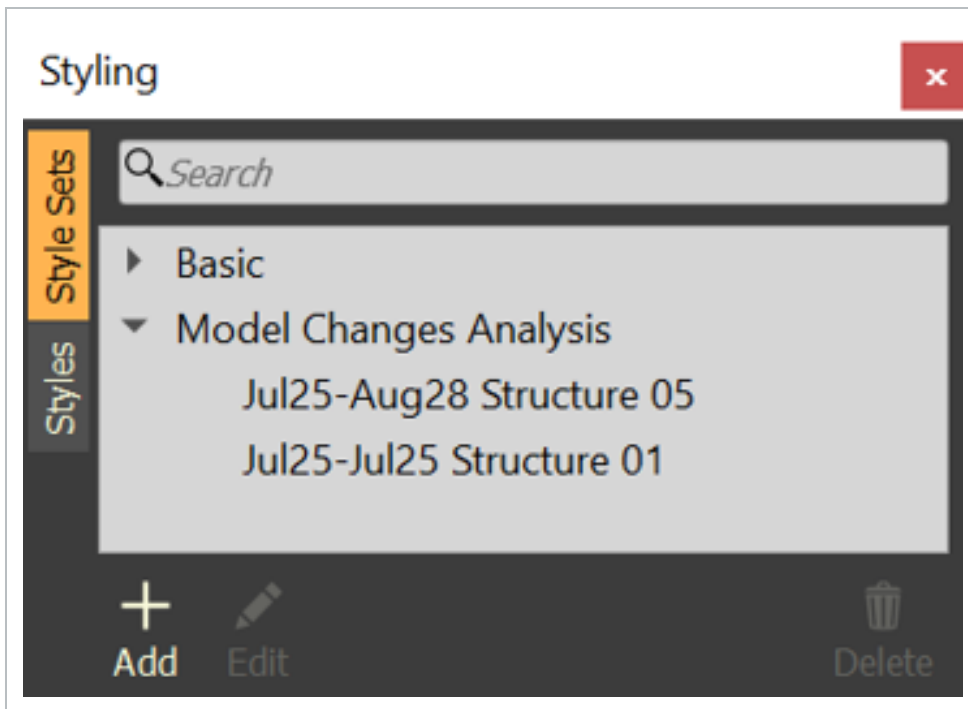

3.5 STEP BY STEP 1 – ANALYZE MODEL CHANGES

1. Have two versions of the model stream published.
2. Within the Project Structure dialog box, select on a model stream to identify the date range to use for the comparison.

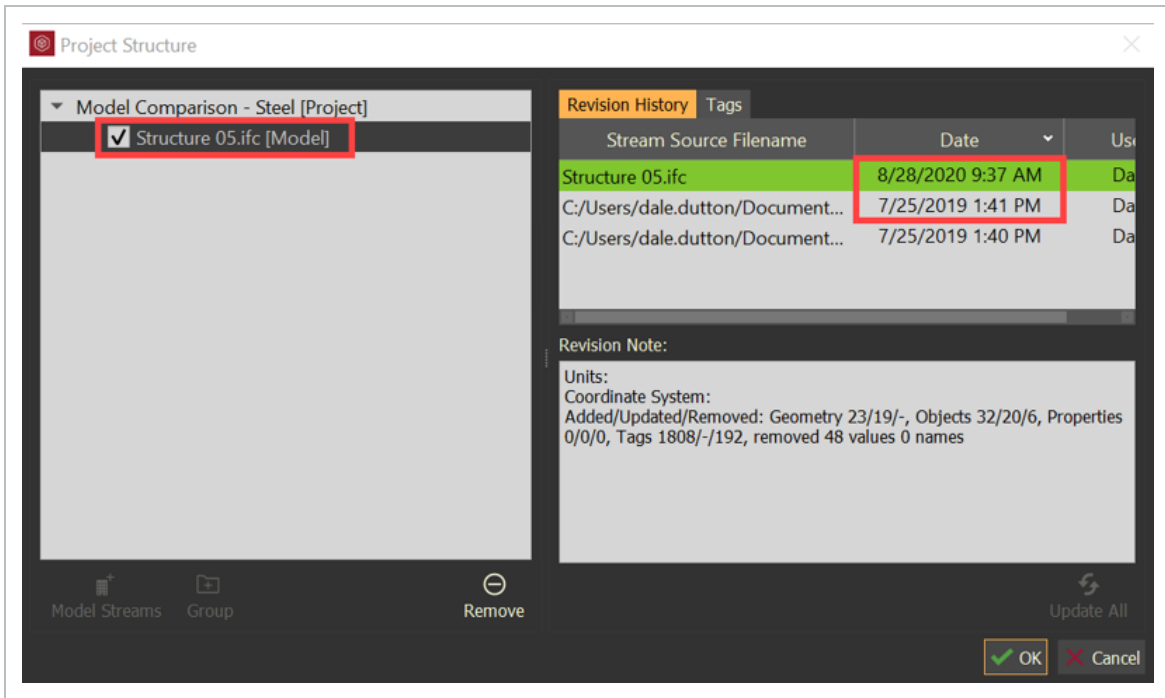

- 3. Close Project Structure dialog box.
- 4. Close Project Structure dialog box.

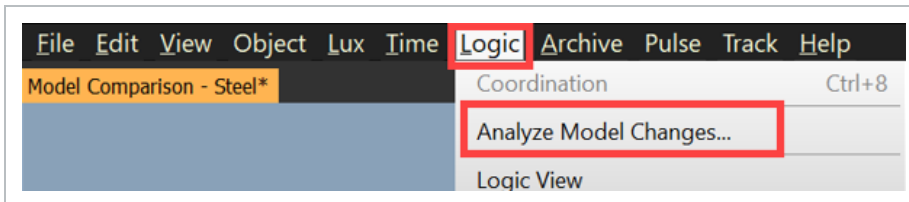

- 5. Select the **Model Stream**, set the date time frames, then click **OK**.

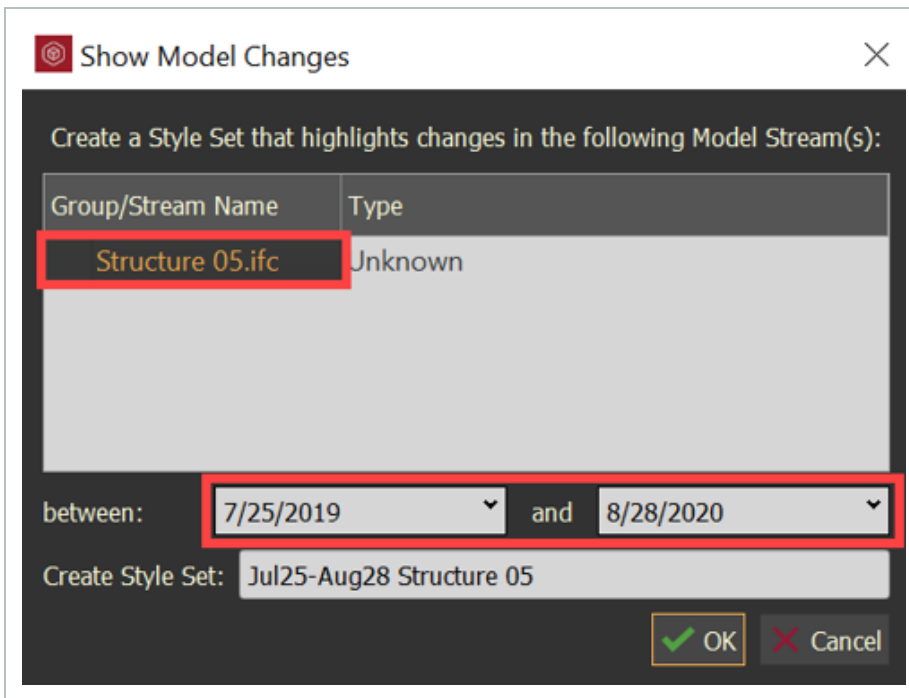

- The Analysis of Model Changes Completed dialog box will open

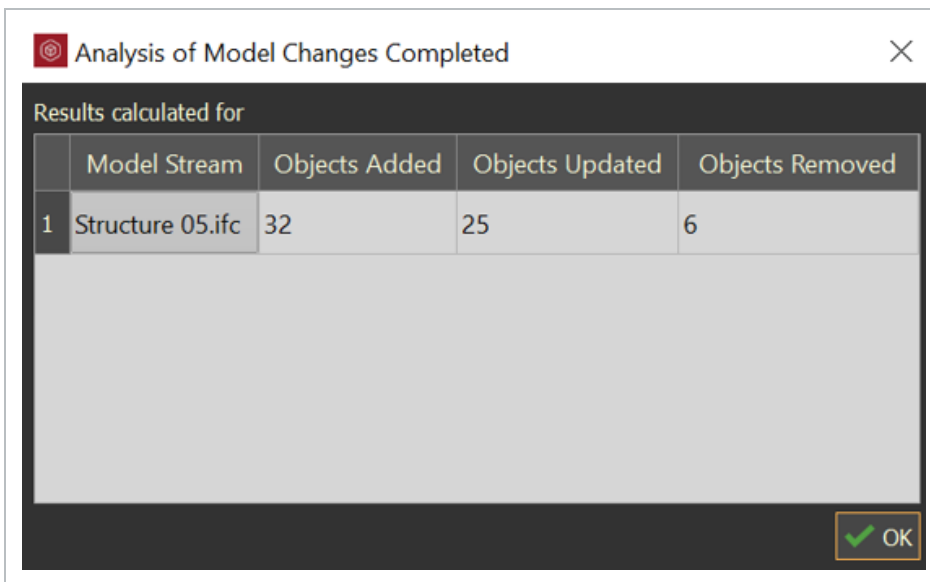

- Tag_User category was created with two values “_added” and “_updated”

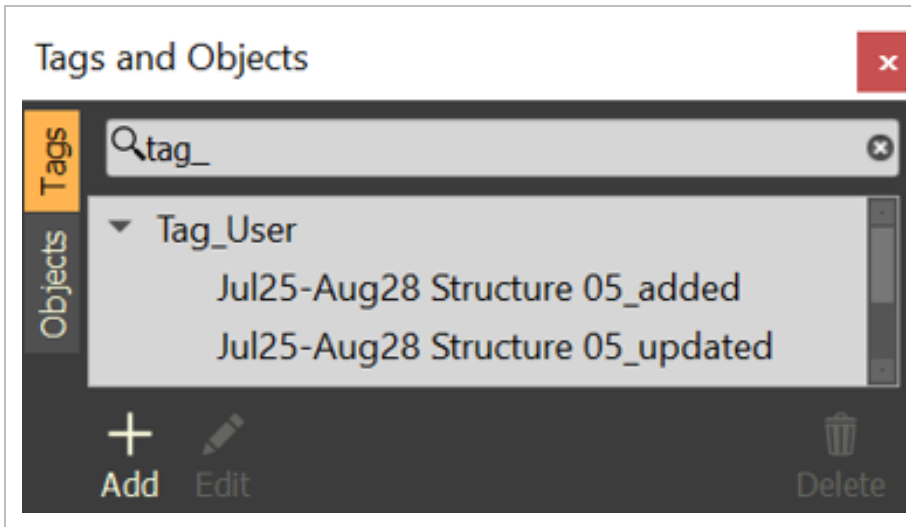

- A Style Set was created coloring the “Added” objects Lime Green and the “Updated” objects Orange

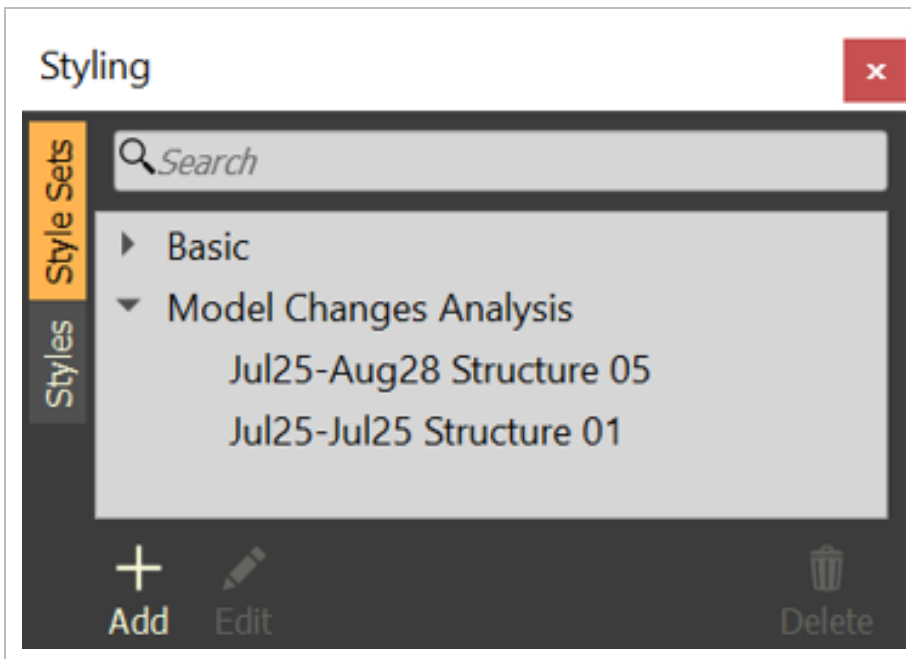

3.6 POINT CLOUD

3.7 POINT CLOUD DATA

Model support of point cloud data enables a more streamlined workflow for projects that incorporate 3D scanning or LiDAR data. You can import, visualize, and manipulate point cloud data in Model. It enhances Model's tools for design visualization, engineering, and any workflow that requires precise real-world data integration.

You can validate design data before and after construction, capture real-time visualization, and have timely issue recognition.

You can perform the following:

- Align and overlay point clouds with existing 3D models.
- Create accurate meshes.
- Refine real-world scans to enhance your designs.
- Capture precise measurements directly from your point cloud data, ensuring accuracy.
- Analyze and validate real work dimensions in your project, such as measuring distances, angles, or volumes.

3.7.1 USING POINT CLOUD

In a model, you can go to View > **Point cloud** to open the Point cloud panel to select your point cloud source file. You can also use the File > **Import** option to import your point cloud source file.

The following images show some point data model functions in Model:

- Measuring and sectioning

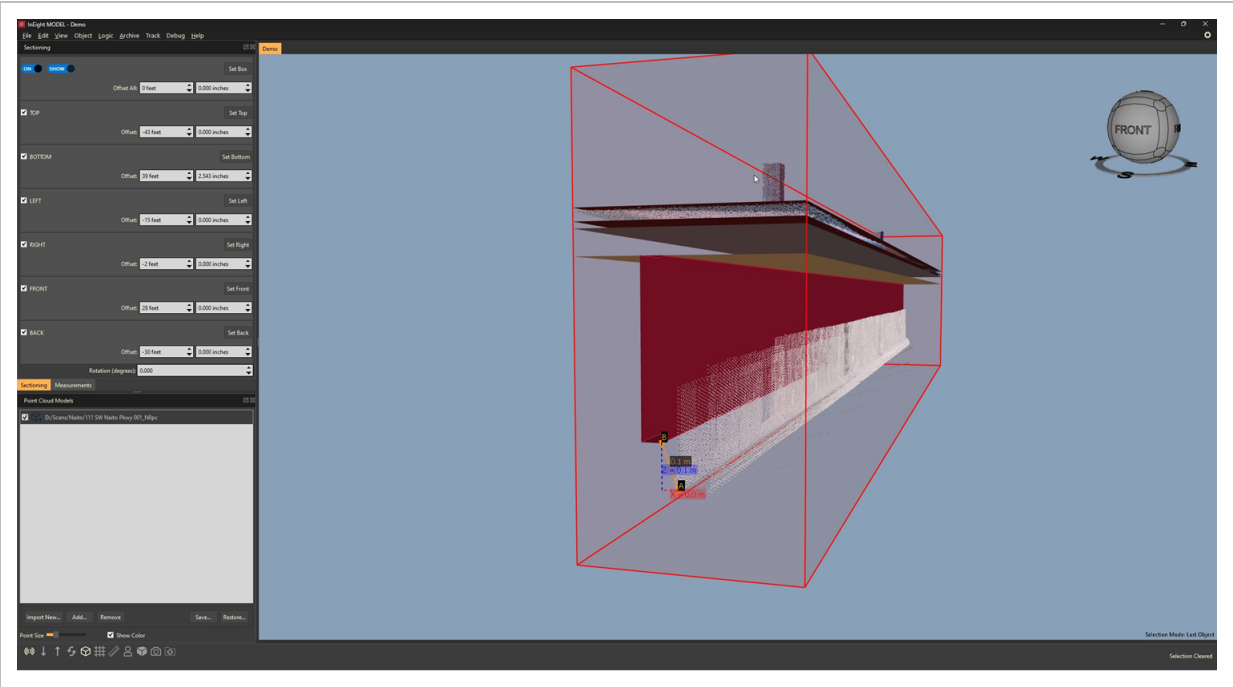

- Grayscale and RGB color comparison

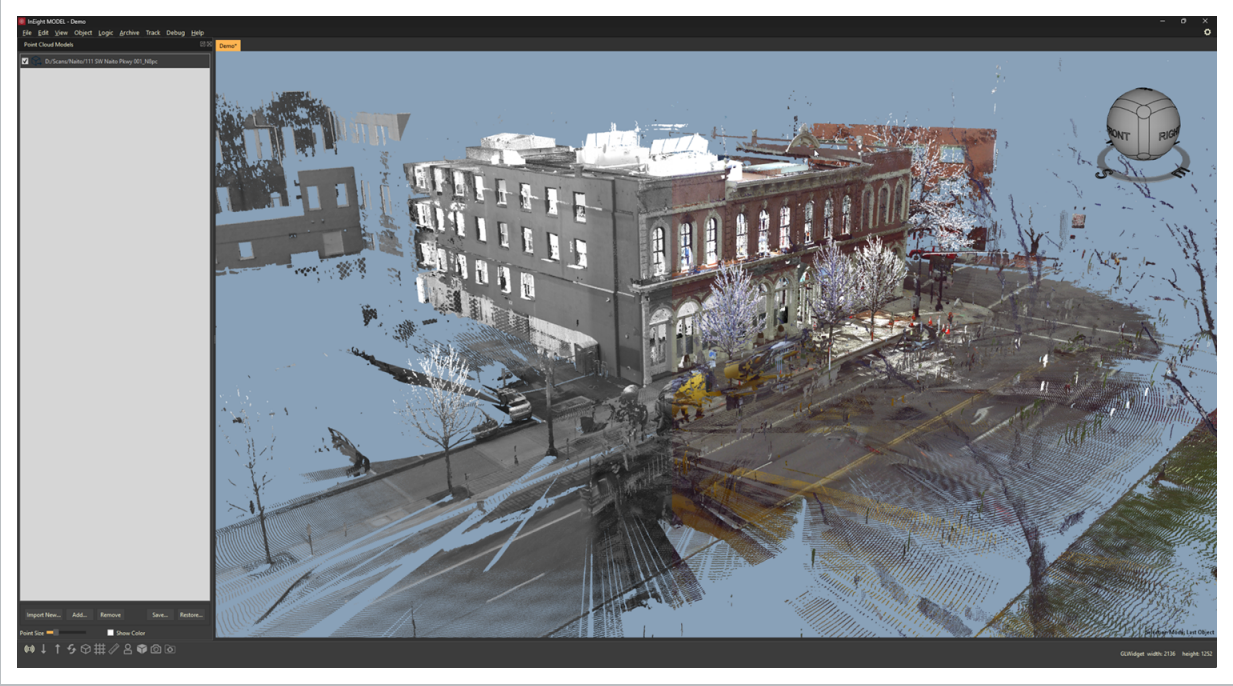

- Dot sizing

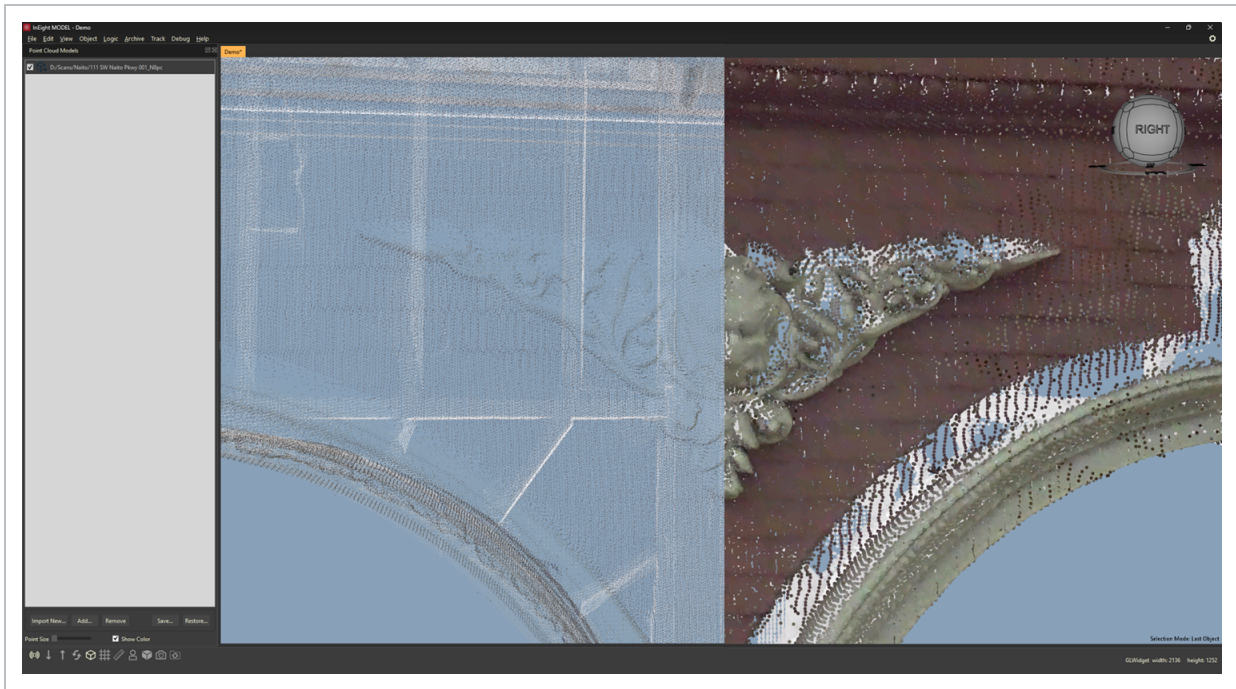

3.7.2 CONSIDERATIONS

Currently only .e57 file type is supported.

This page intentionally left blank.

CHAPTER 4 – PROJECT STRUCTURE

4.1 PROJECT STRUCTURE OVERVIEW

Project Structure is where model streams are housed after the export from authoring tools or the import of IFC type files. It provides the ability to interact with model streams by grouping and organizing, removing, temporarily disabling, accessing the revision history, importing other models streams from other projects in the environment, and more.

4.1.1 PROJECT STRUCTURE PANEL

To access the **Project Structure panel**, Select **File** from the menu bar at the top of the screen. Then, select **Project Structure**.

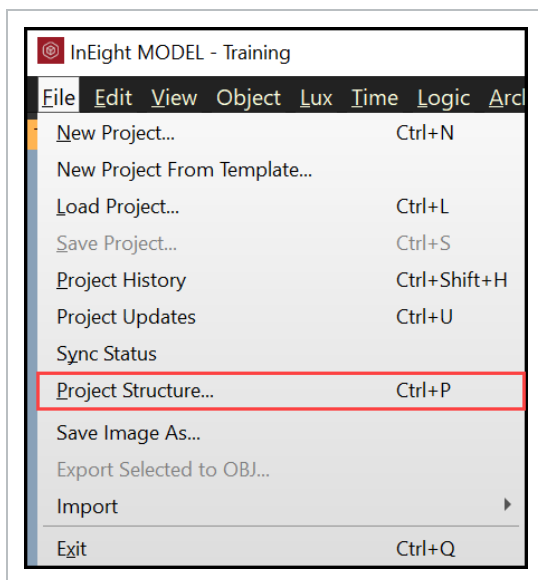

This will open the Project Structure panel.

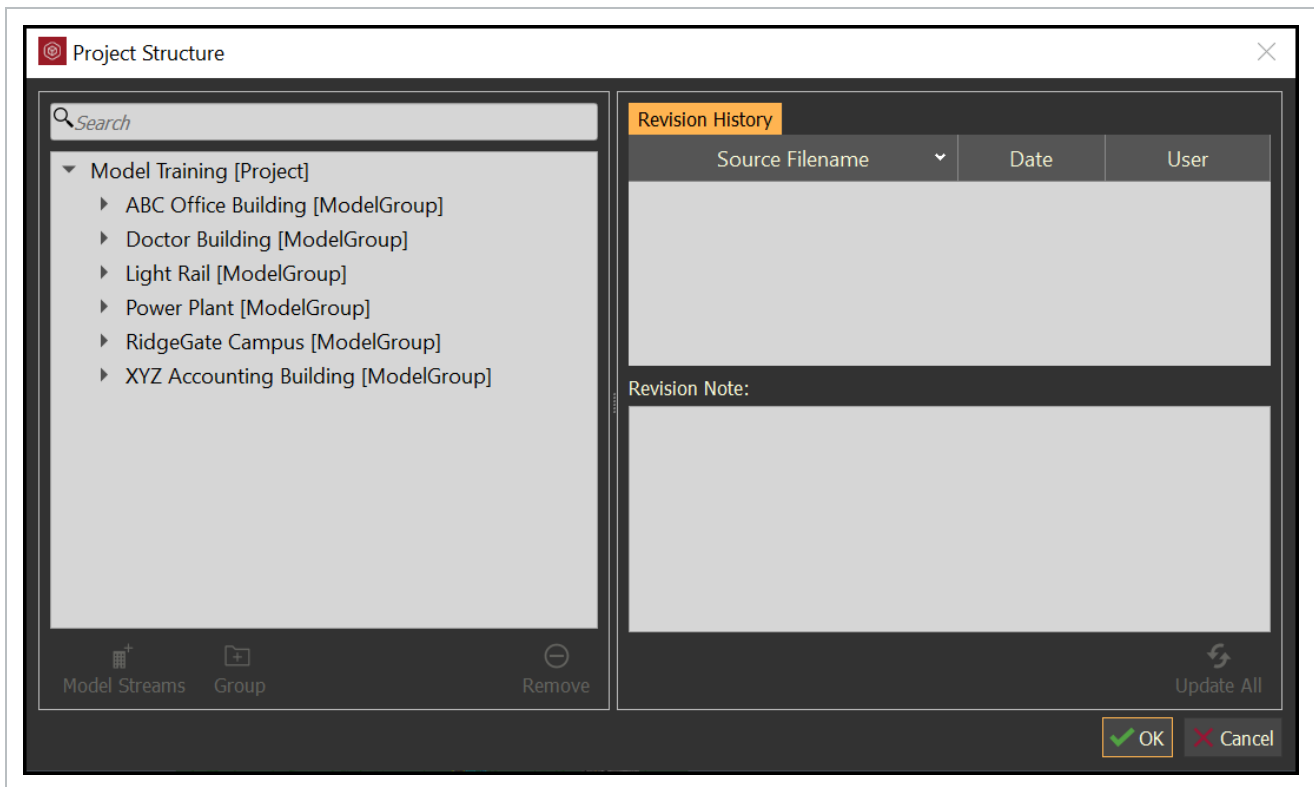

By selecting the project name within the tree structure, all the project **Revision History** will be displayed. Select on a revision to review the **Revision Notes**.

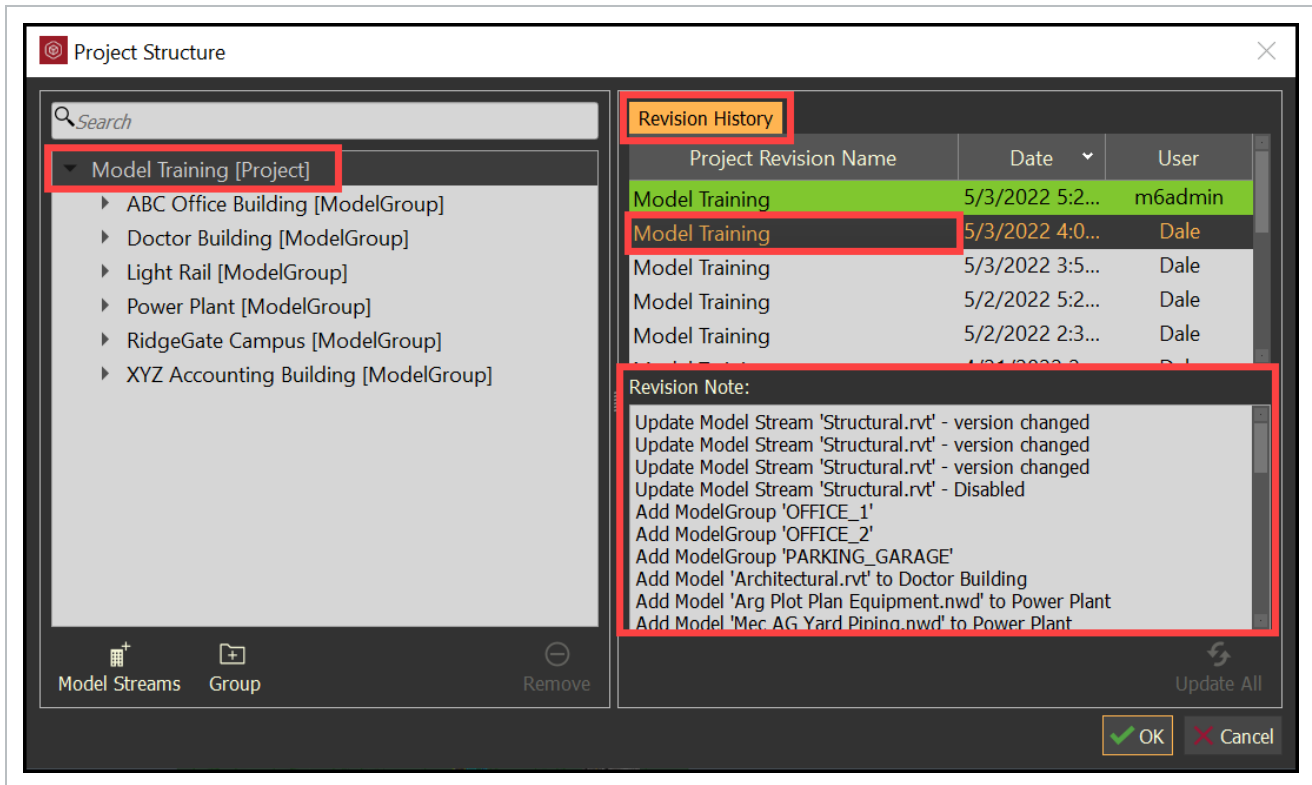

4.2 ORGANIZE MODEL STREAMS

Create groups within the Project Structure tree to organize the model streams for the project. Groups can be created before and or after model streams have been imported into the project. Model Stream Placeholders can also be created identifying anticipated or planned project model streams.

4.2 STEP BY STEP 1 – CREATE GROUPS

1. Select the **project name**.
2. Select the **Group** icon.

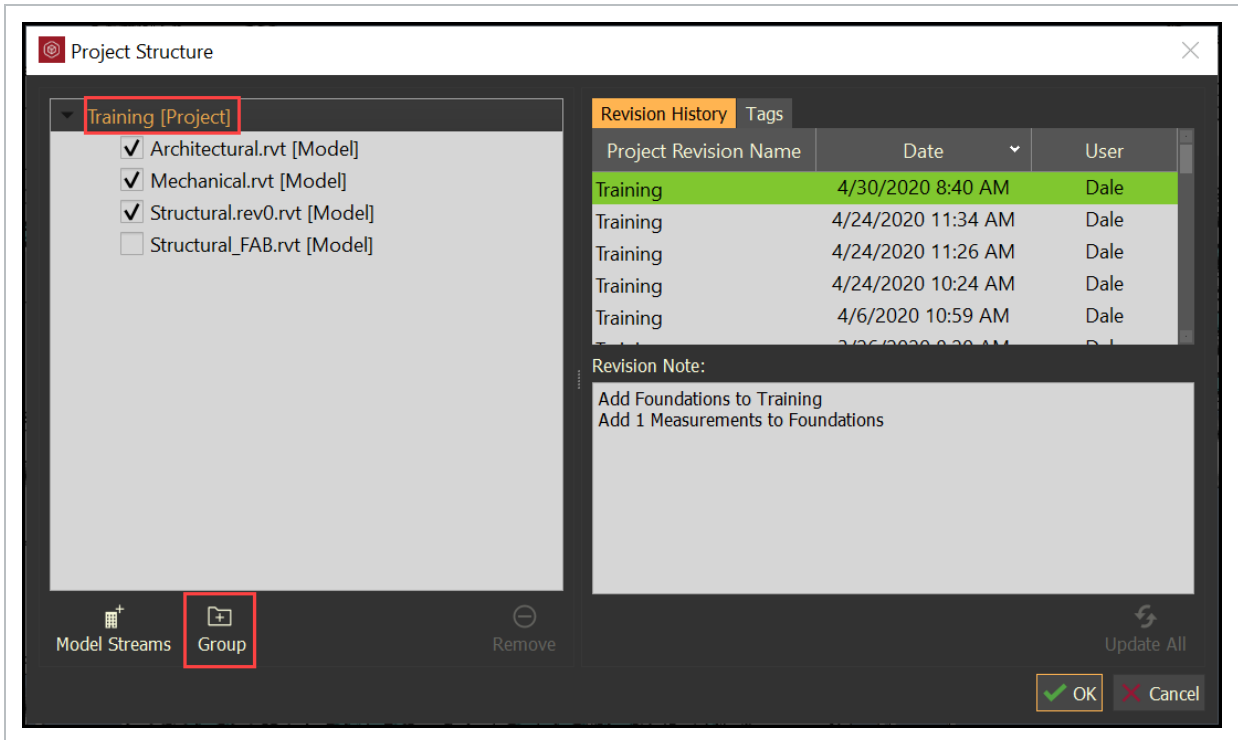

3. Type in a group name, then click **OK**.

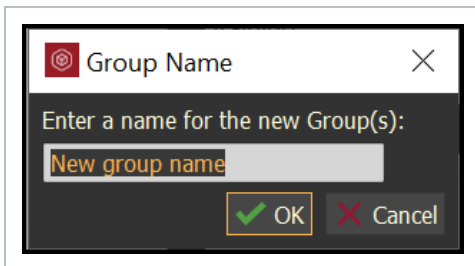

4. Drag and drop model streams into group folders.

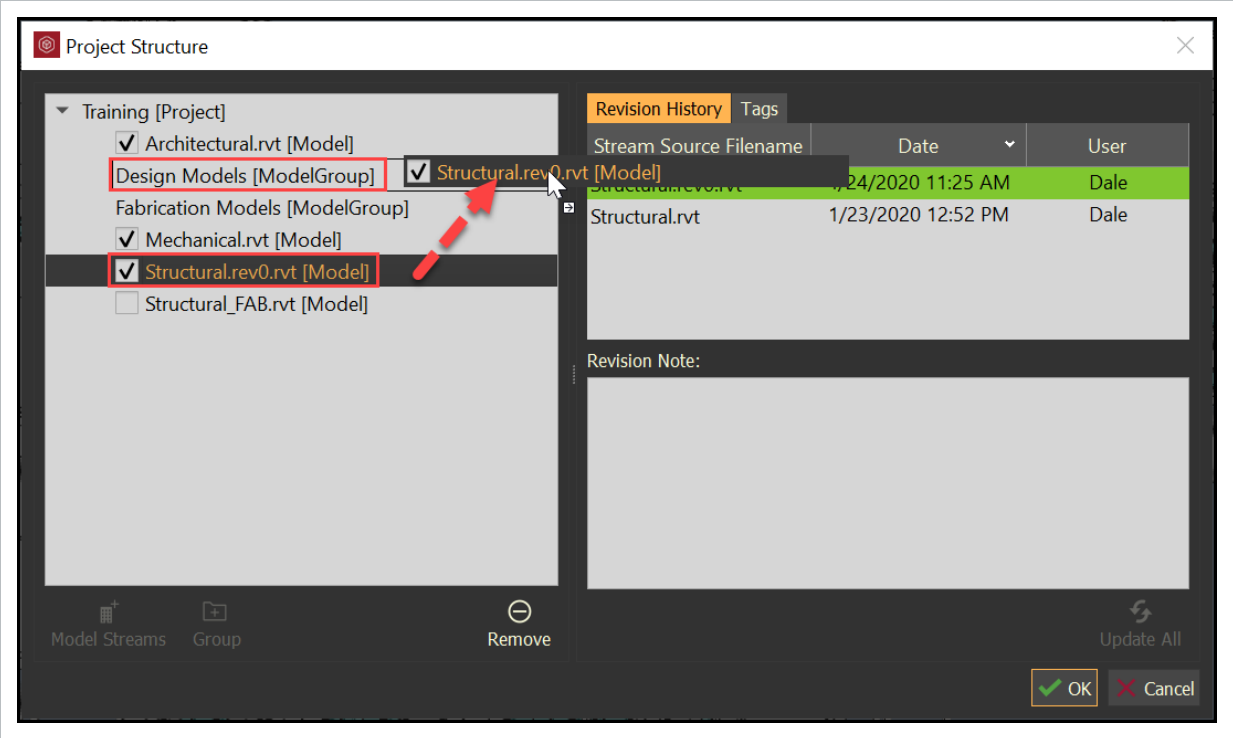

- Possible results of organized models

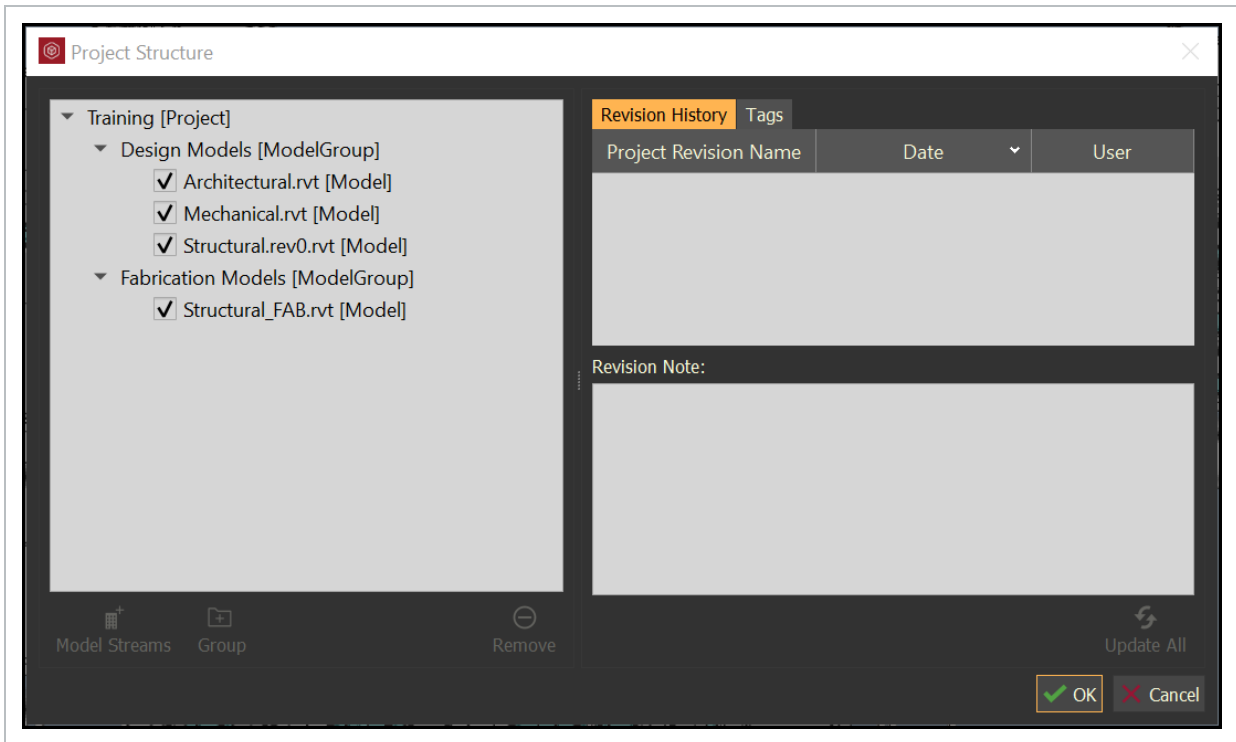

NOTE Once a group name has been created it cannot be renamed. A new group name will need to be created, then you can drag and drop the model streams from one group to the other.

4.2 STEP BY STEP 2 – DELETE GROUPS

1. Select the group name to be deleted.

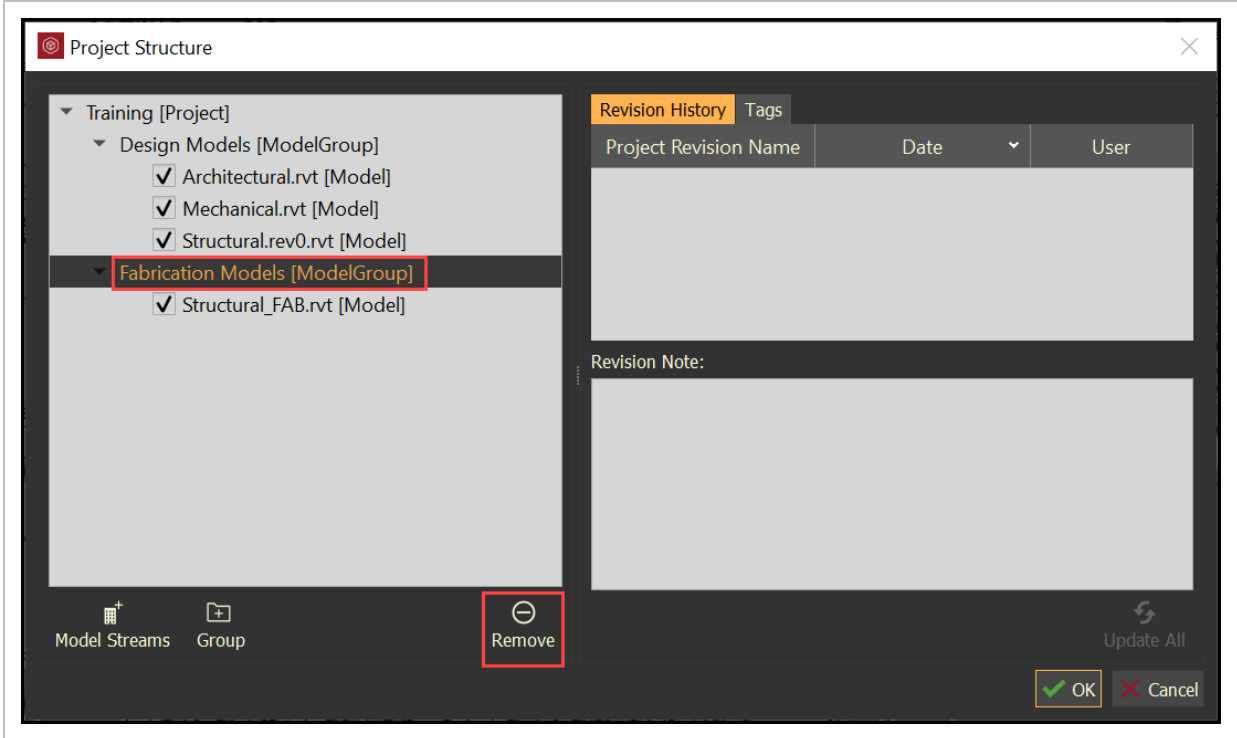

2. Select the **Remove** icon.

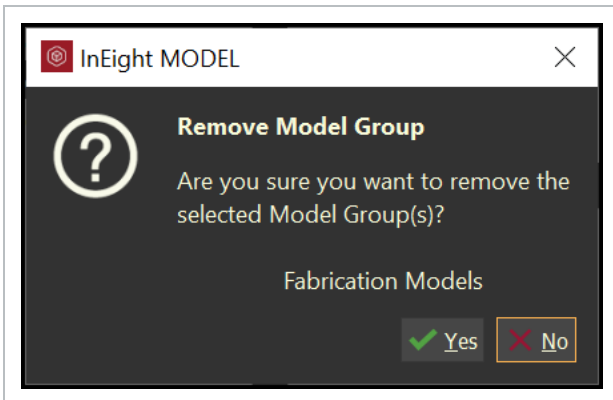

- The Remove Model Group confirmation dialog box will open

NOTE Any model streams within the group that is being removed will be removed as well. The model streams will remain in the database, but not visible within the current project.

TIP The Project Structure will be replicated within the Objects tab within the Tags and Objects Panel.

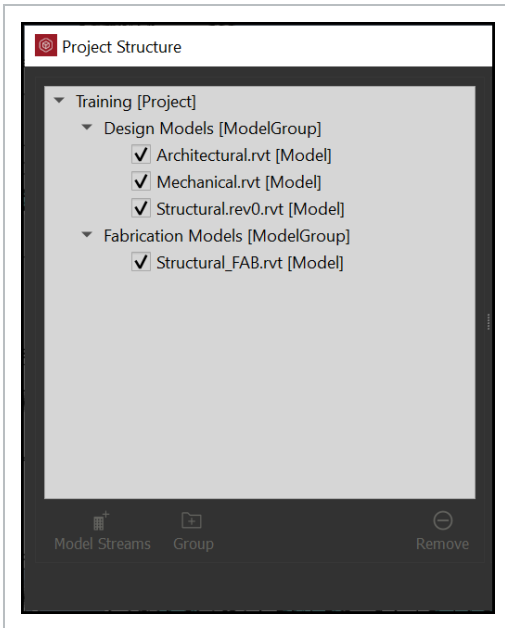

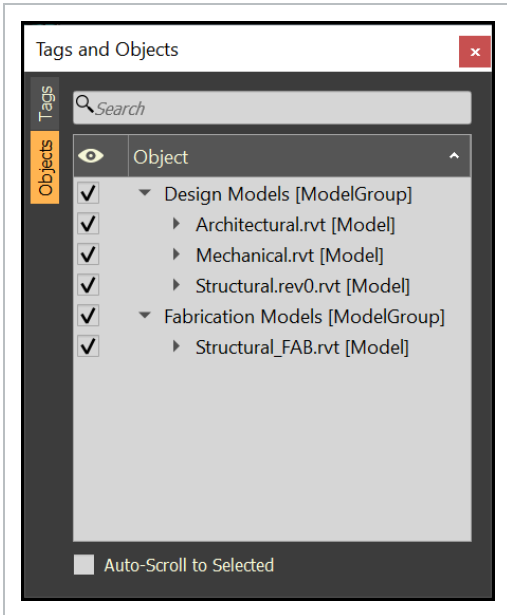

4.2 STEP BY STEP 3 – CREATING A MODEL STREAM PLACEHOLDER

1. Select on the **Project** or the **Group** for the desired Model Stream placeholder.
2. Select the **Model Streams** icon.

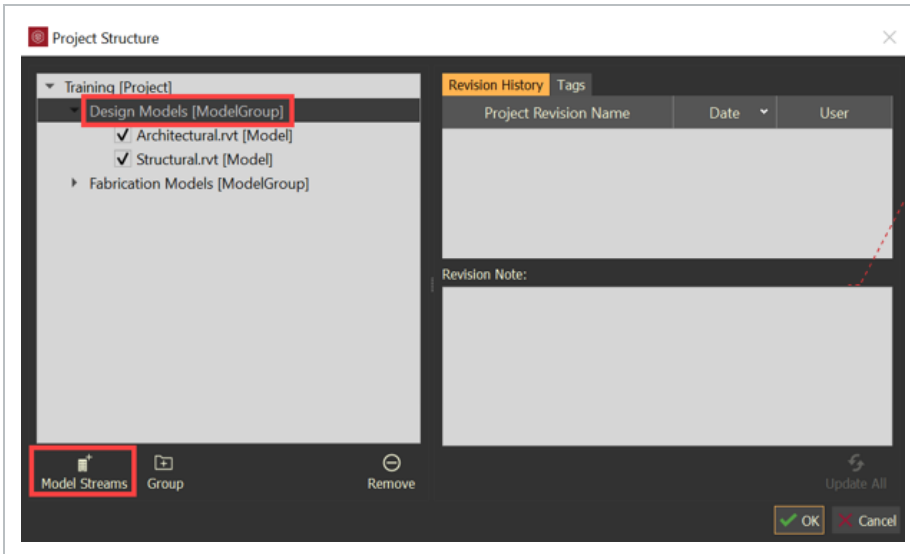

3. Select the **Add Placeholder** icon.

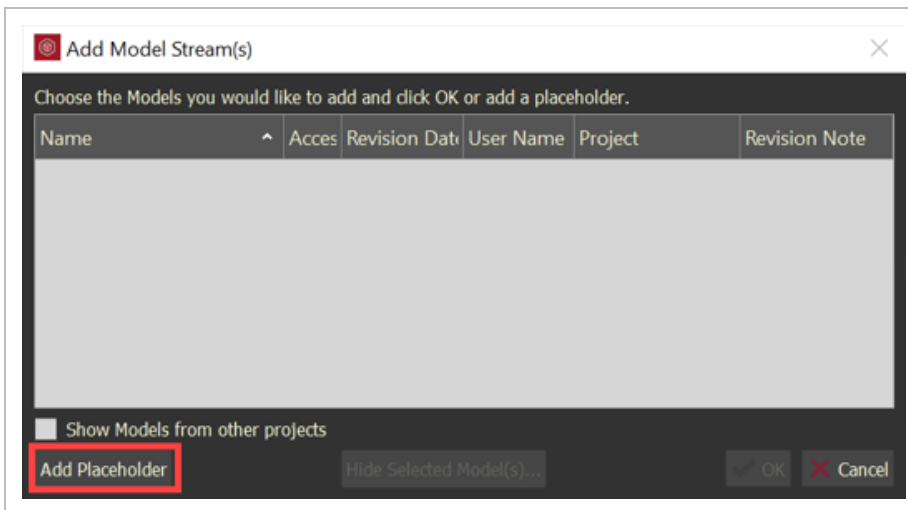

- The Remove Model Group confirmation dialog box will open

4. Type in the anticipated or planned Model Stream name.

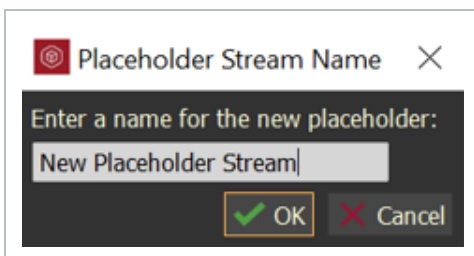

- The Model Stream Placeholder will appear in red until a model stream is uploaded in its place

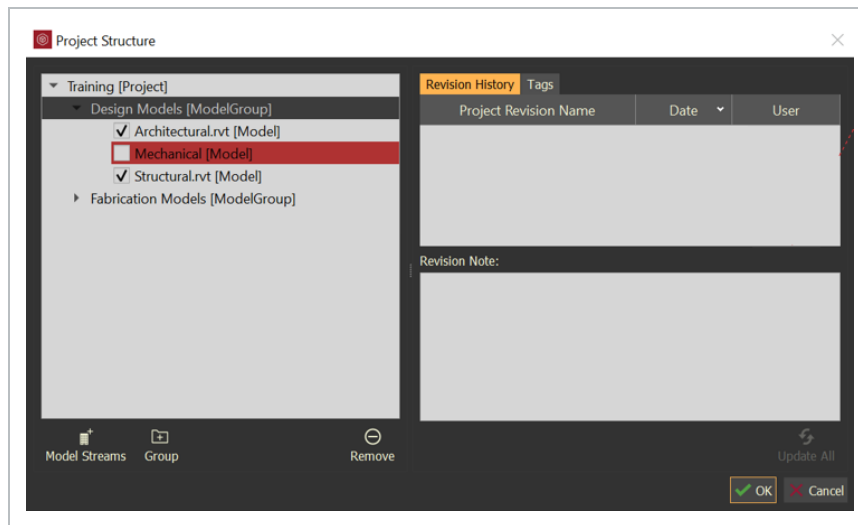

4.3 MODEL STREAM MANAGEMENT

When a model stream is updated from a plugin, a new revision is created in the Project Structure. The **Project Structure** lets the administrator switch the revision of any given model stream in the project.

4.3 STEP BY STEP 1 – CHANGE THE ACTIVE MODEL STREAM REVISION

1. Within the Project Structure tree, select a model stream.
2. Double click on an older revision.

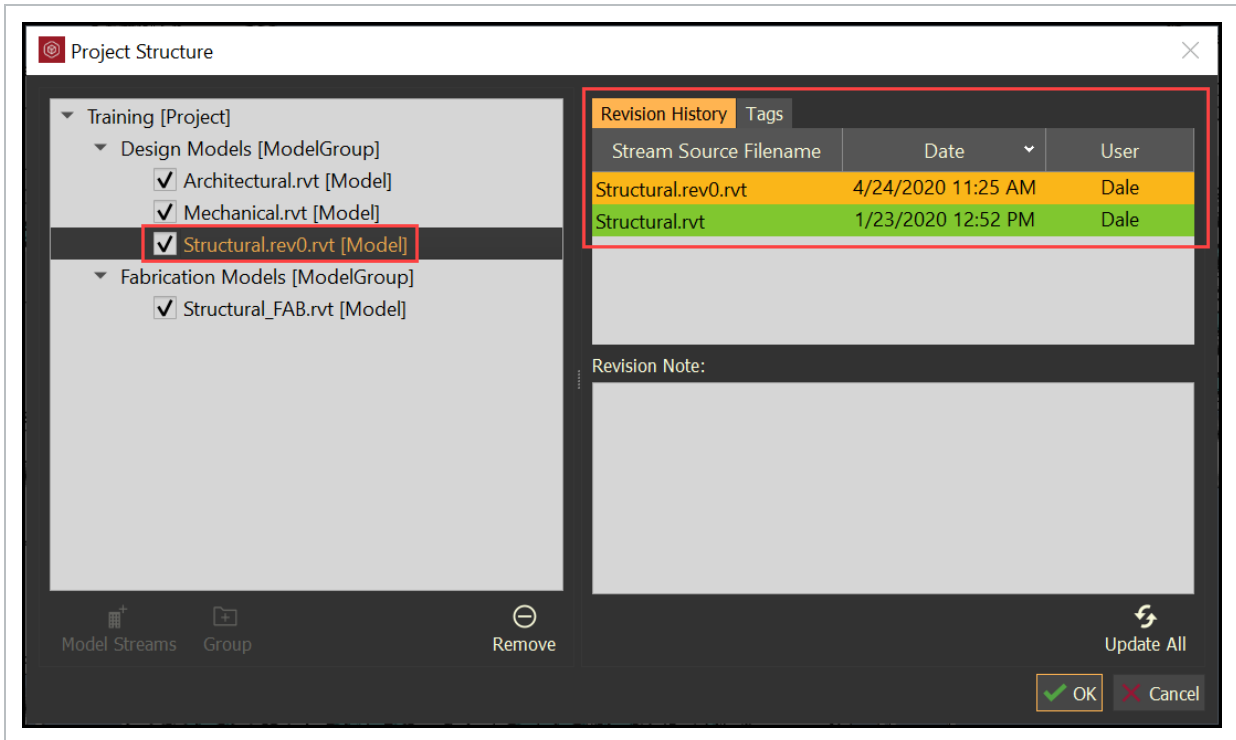

NOTE The current active revision is highlighted in green and the most recent prior revision is highlighted in yellow.

If an administrator changes the revision of any model stream and proceeds to save the project, any user loading the project or accepting updates will also be viewing the historical revision chosen by the administrator. This allows the administrator to roll back to a previous revision, if the latest revision is incorrect or non-compliant.

TIP A model stream will be highlighted in yellow if there is a new model stream revision, but not set as the active revision.

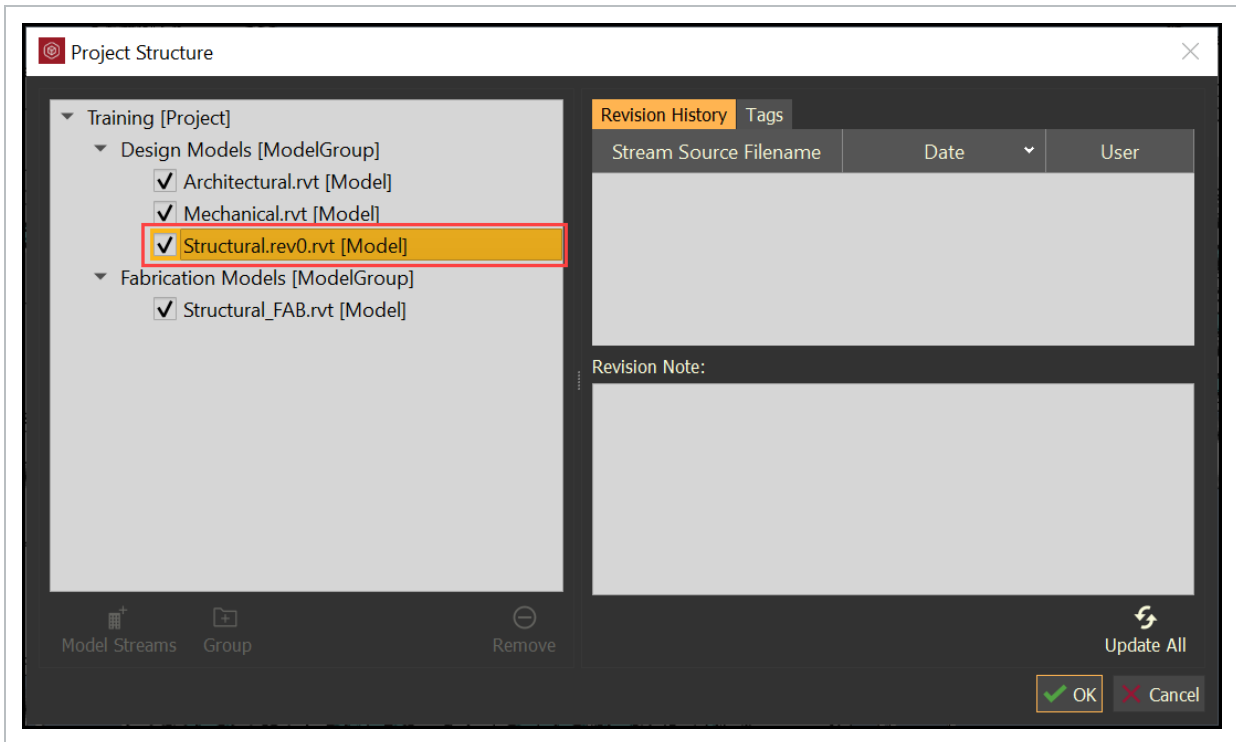

4.3 STEP BY STEP 2 – UPDATE MODEL STREAM REVISIONS

1. Within the Project Structure panel, click the **Update All** icon.

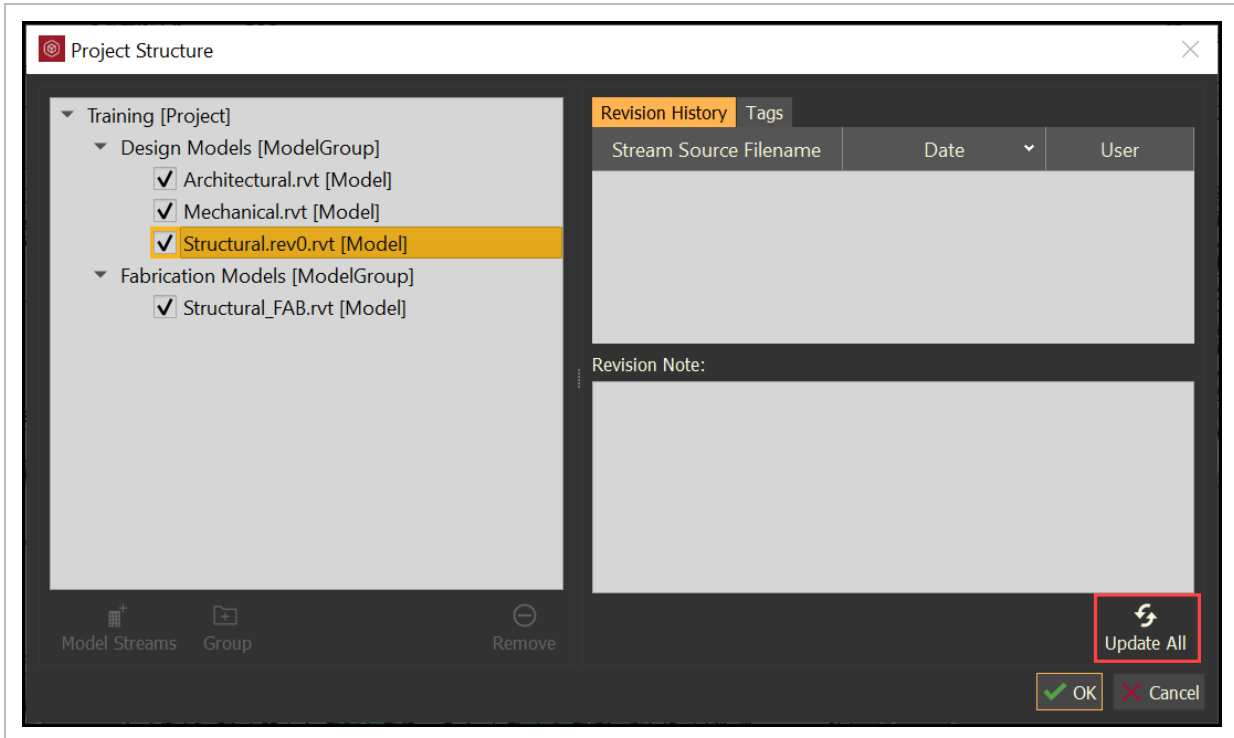

NOTE Update all will update all model streams to the latest revision.

TIP The Update All icon will not be available if there are no old revisions active.

4.3 STEP BY STEP 3 – DISABLE MODEL STREAMS

1. Uncheck the box next to the model stream.
2. Click **OK**.
3. Save the project.

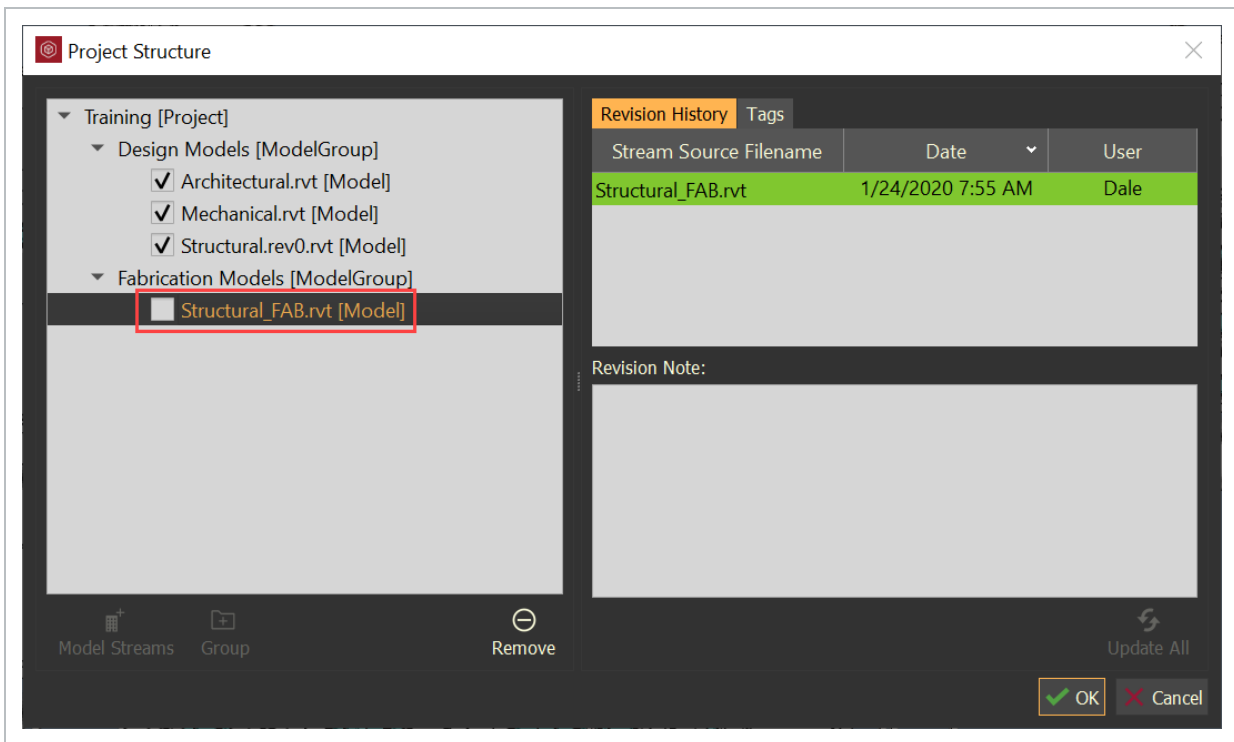

- Once the project is saved, then the model stream is hidden from the project users

4.3 STEP BY STEP 4 – REMOVE MODEL STREAMS

1. Select a model stream.
2. Select the **Remove** icon.

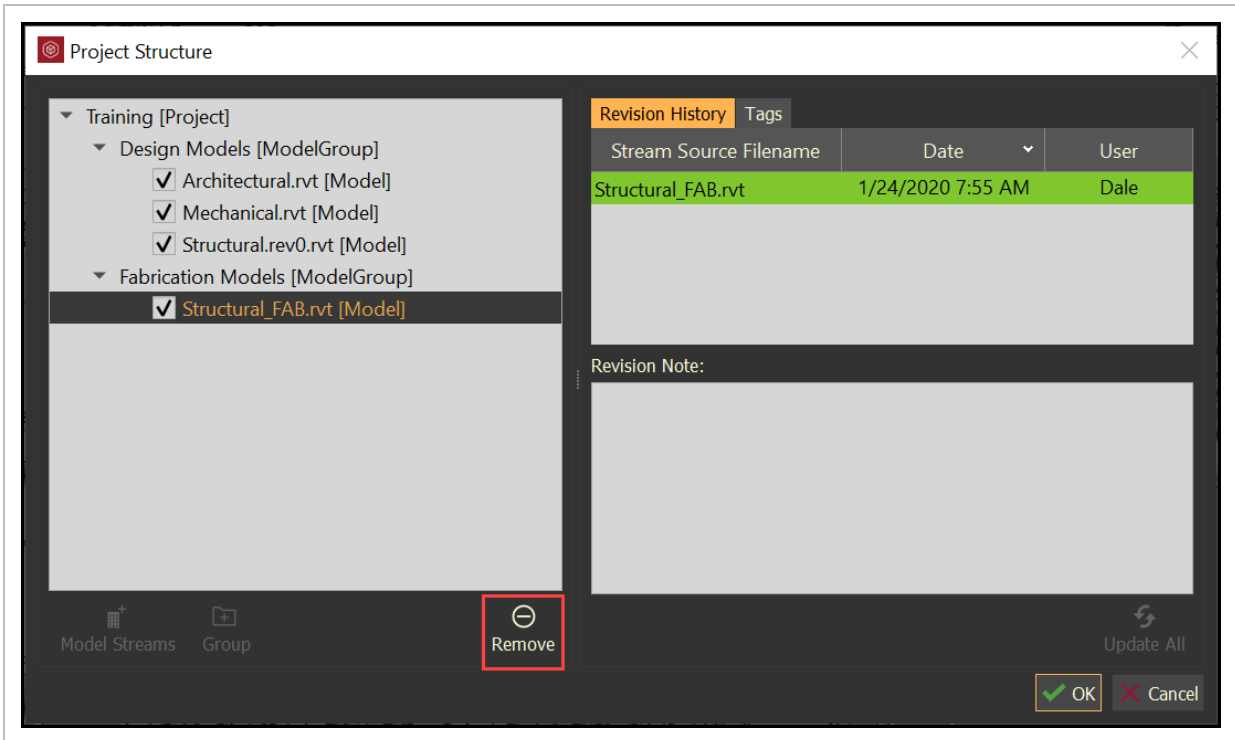

- The Remove and Discard dialog box will open

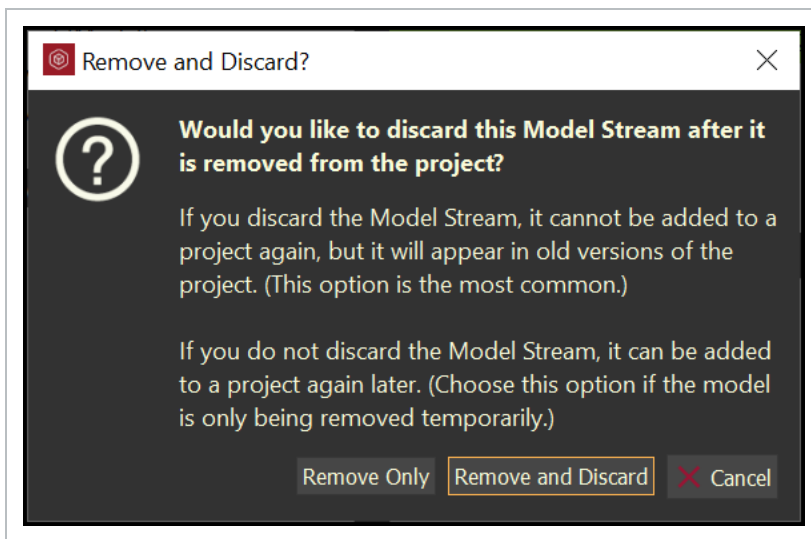

- **Remove Only** -will remove the selected model stream from the current project but it will not remove it from the database

- **Remove and Discard** - will remove the selected model stream from the database.

4.3 STEP BY STEP 5 – ADDING MODEL STREAMS FROM OTHER PROJECTS

Model streams that have been removed with the **Remove Only** command can be reloaded through the **Add Model Stream** icon.

Model streams within the same environment, but in a different project, are accessible to be included in any project within the same environment.

1. Select the root project name or a group folder.
2. Select the **Model Stream** icon.



- The Model Stream dialog box will open

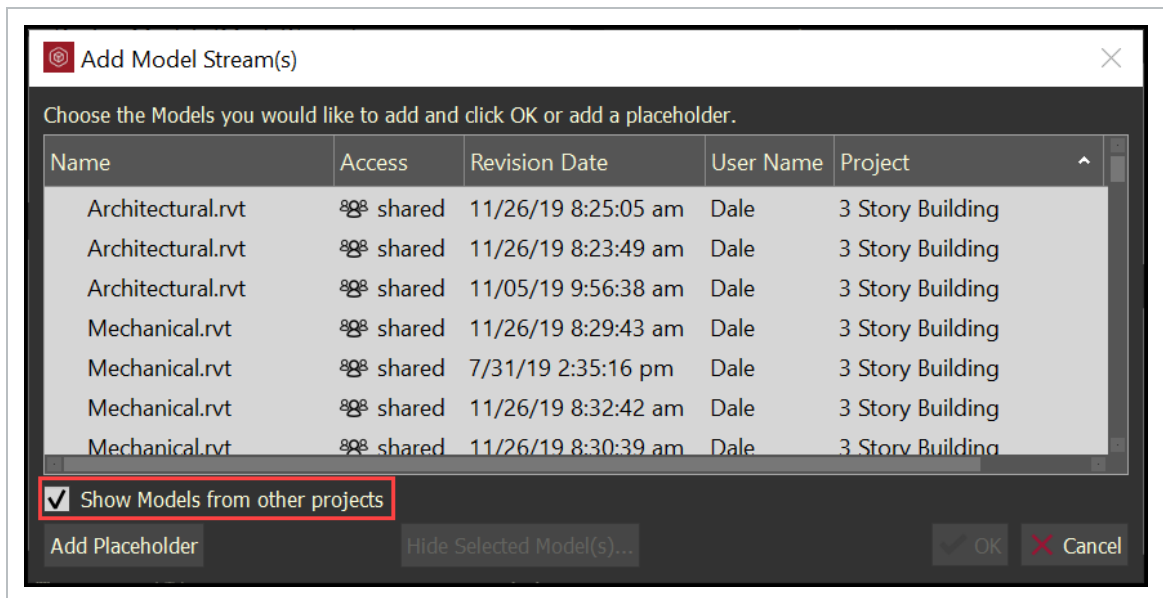

3. Select the desired models to be added to the current project, then click **OK**.

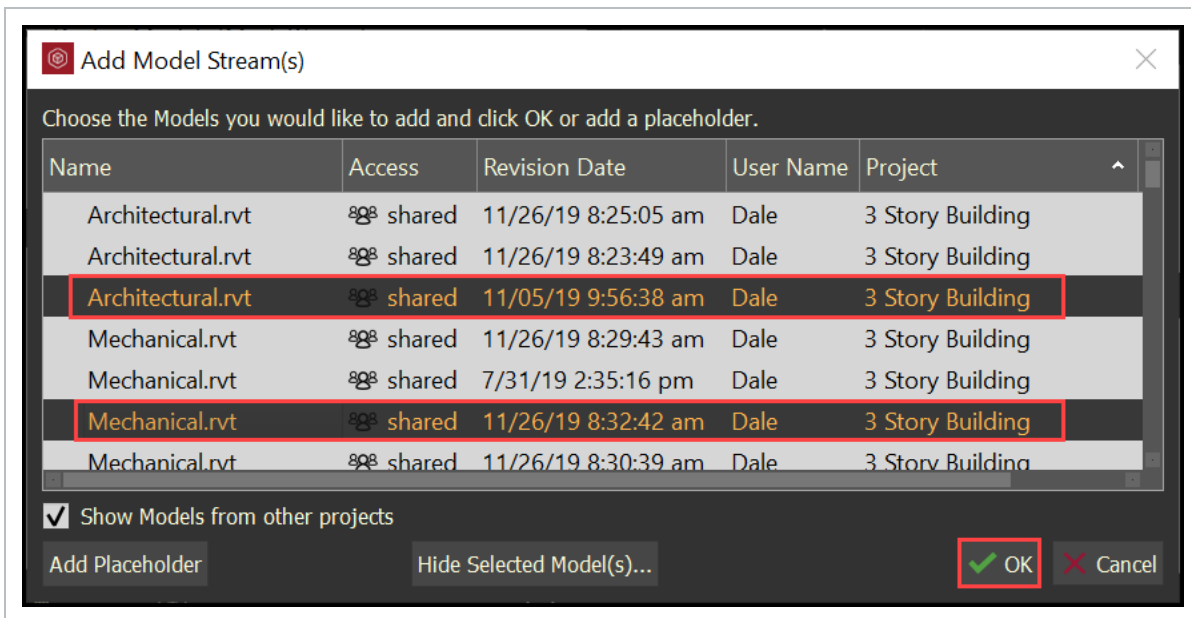

NOTE The select model stream of the particular revision date will be added to the current project along with all older revisions of the model stream.

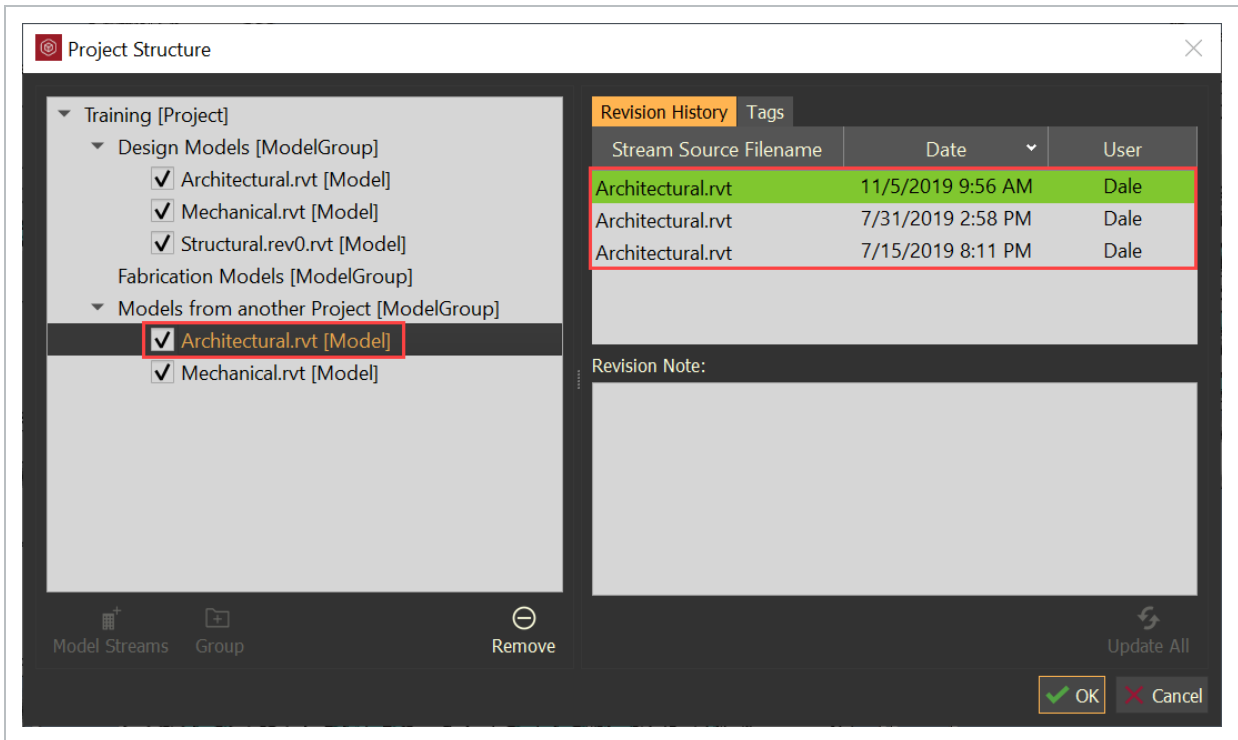

4.3 STEP BY STEP 6 – PUBLISH A MODEL STREAM INTO A PLACEHOLDER

Model Stream Placeholders show as red until a model has been published to replace it.

1. With Model open and the Design Authoring tool (that is, Revit) open, select the **Export Model Stream** icon.

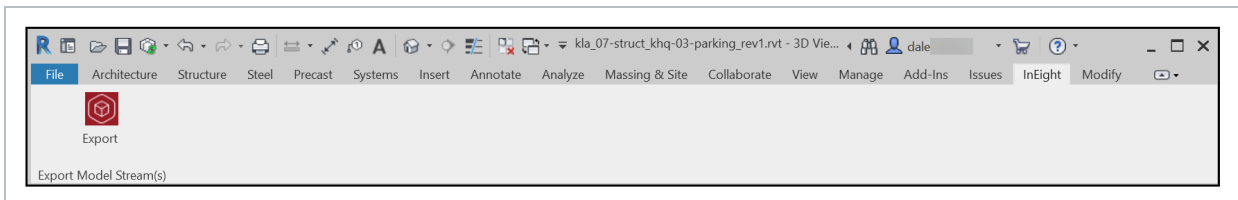

- The Model Exporter dialog box opens.

2. Select **Choose Location**.

- Even though there is a placeholder that nearly matches the name of the design file, the design file has not been published yet, so it is recognized as a new model

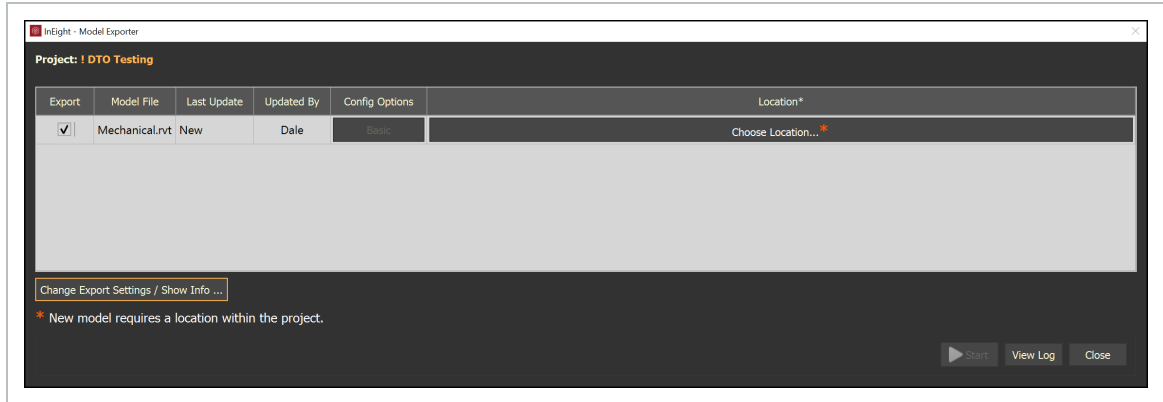

- The Choose Location dialog opens.

3. Select the folder where the Model Stream placeholder is identified.

- In this example, Mechanical is the placeholder.

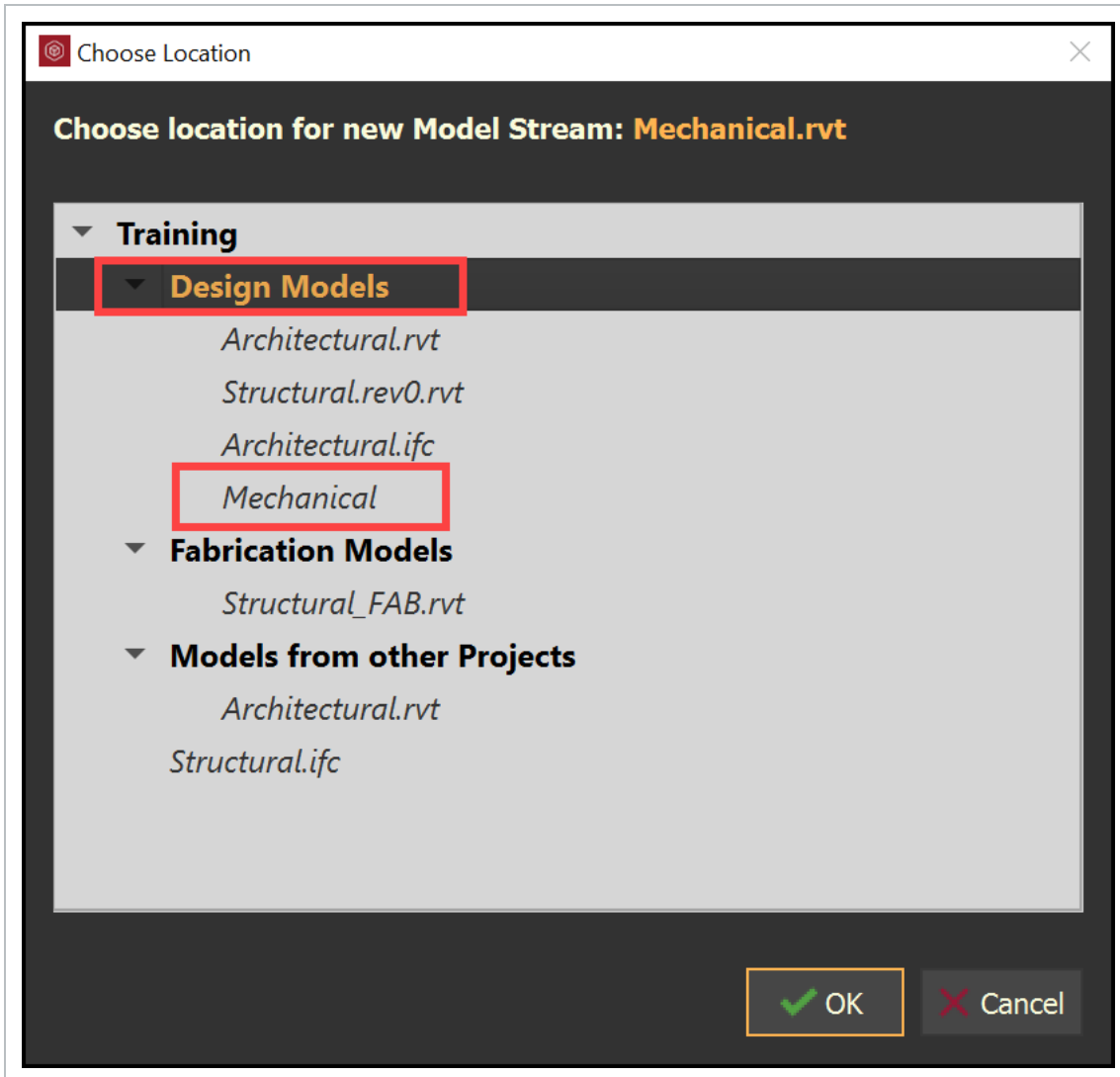
4. Click **OK**.

NOTE The new model stream does not replace the placeholder until it is linked to it.

5. Select **Basic** config options.

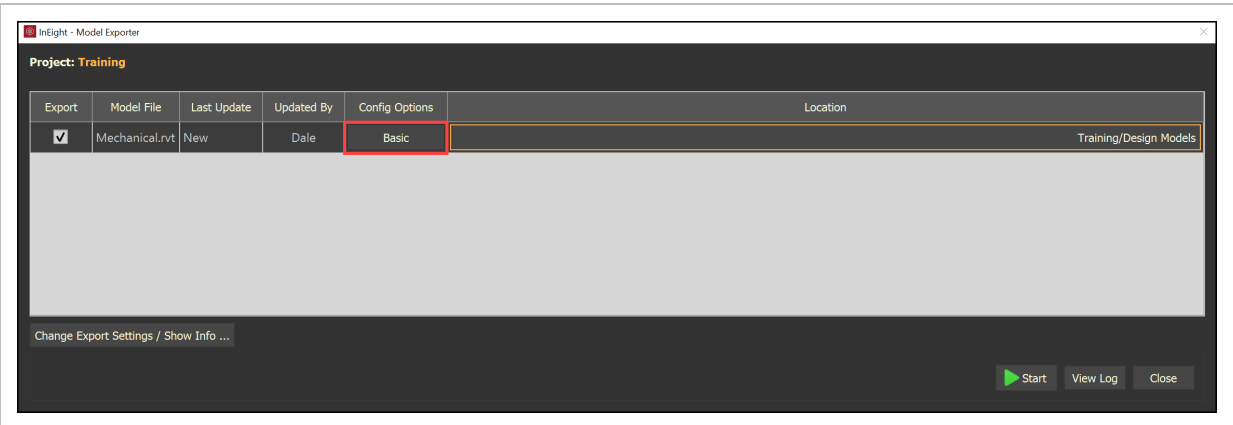

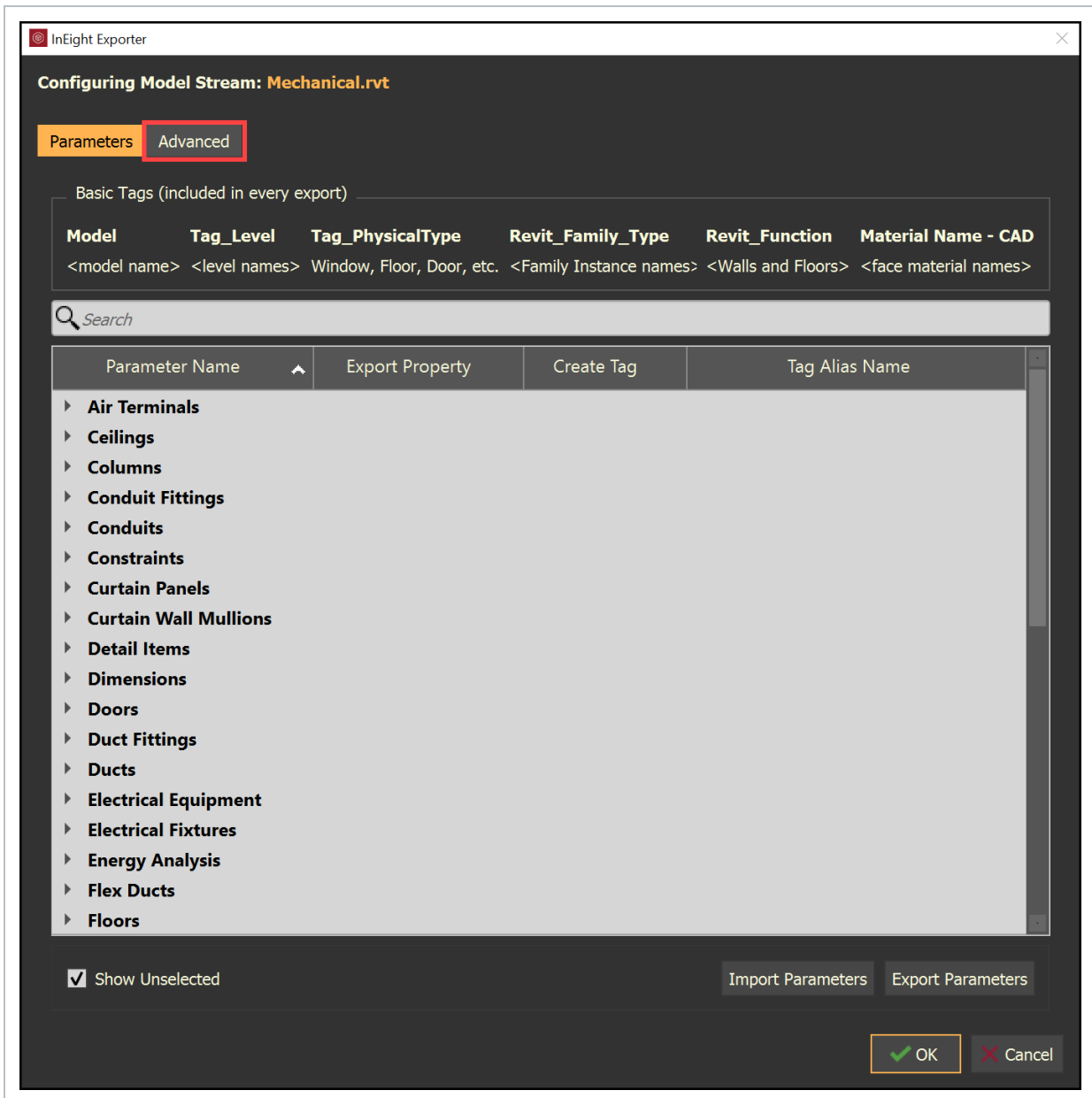
6. Select the **Advanced** tab.

7. Select Choose different model...

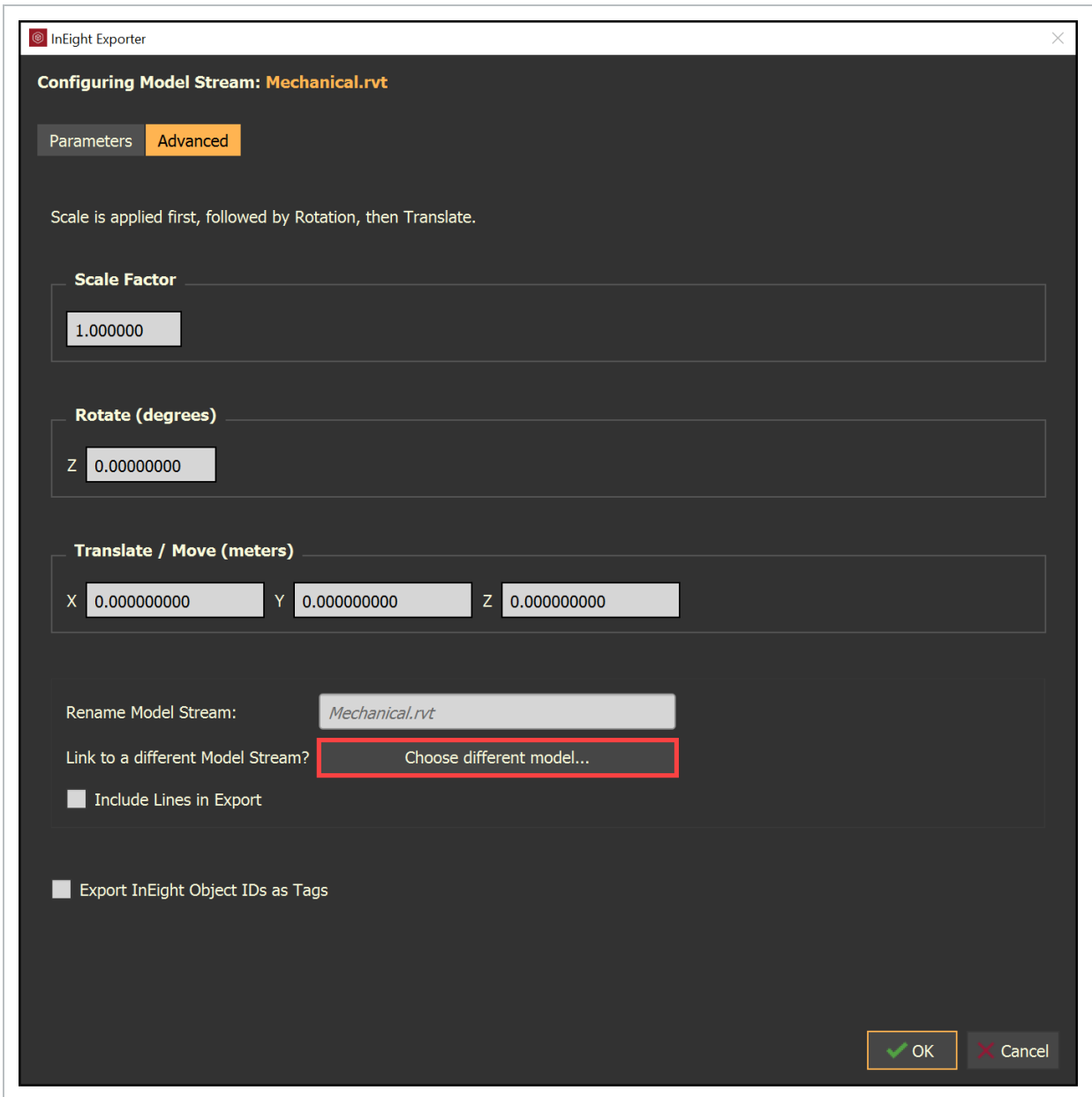

8. Select the **model stream placeholder**, and then click **OK**.

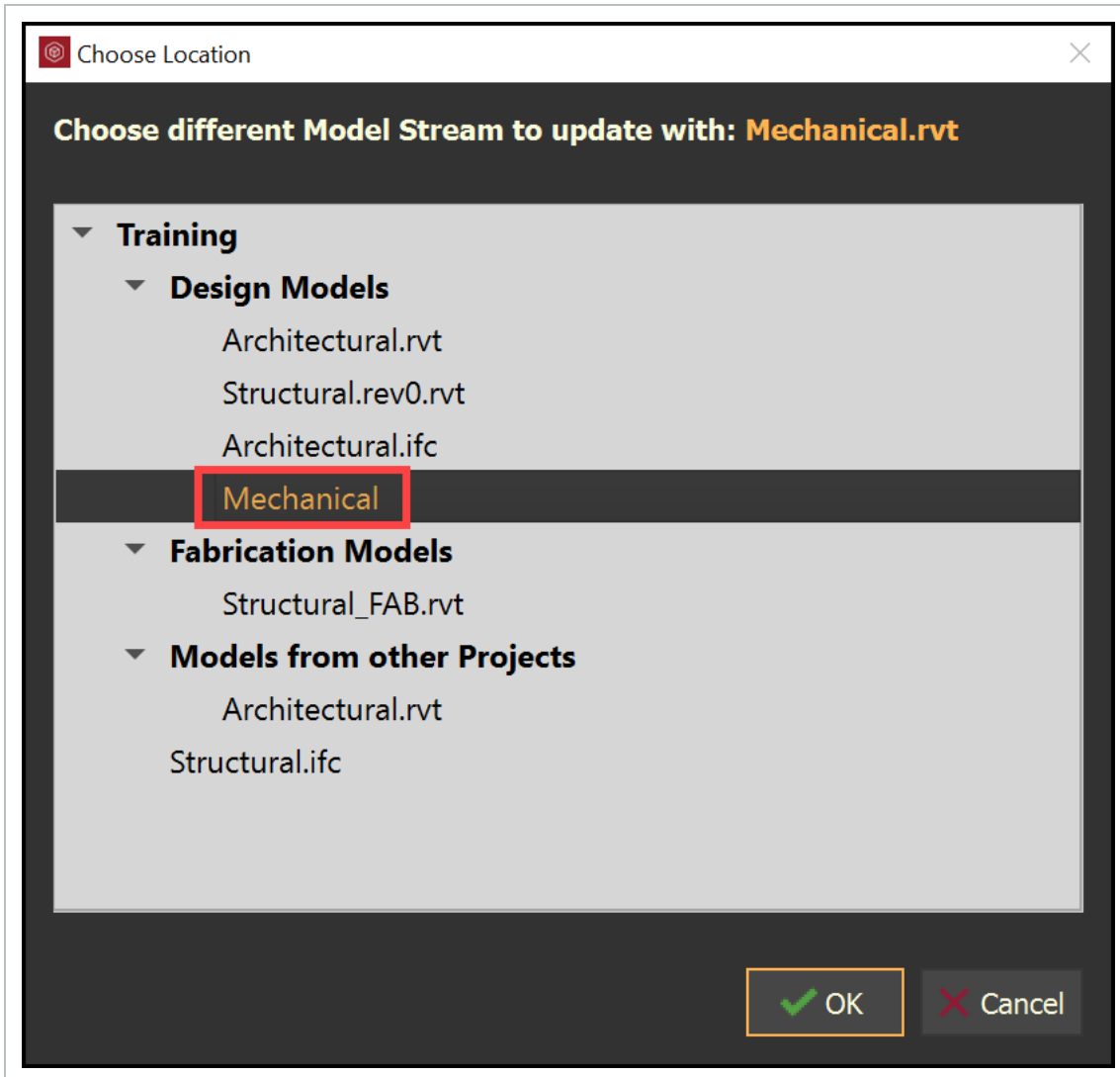

9. Click **Start**.

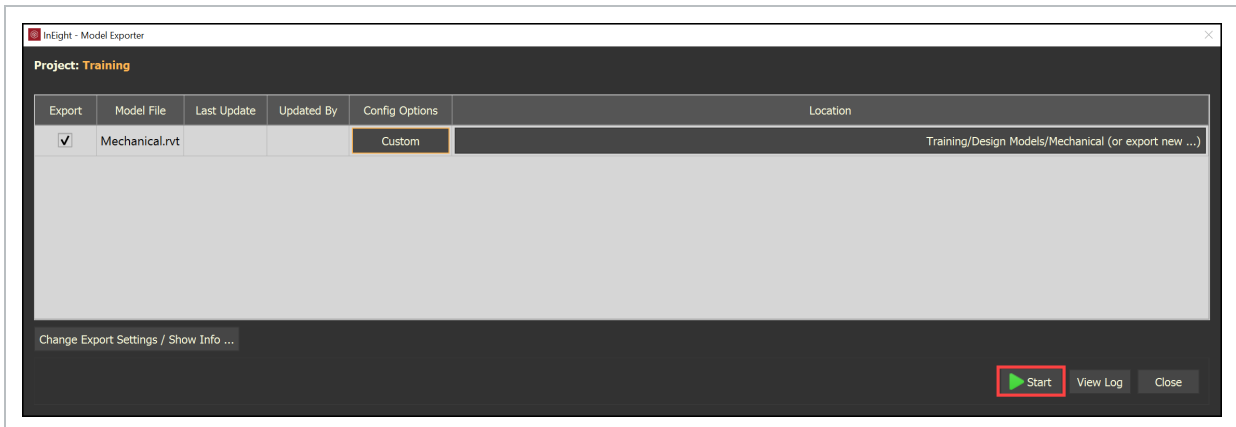

10. Save the model stream to the project.

- In the Project Structure, the new Model Stream has replaced the Model Stream placeholder.

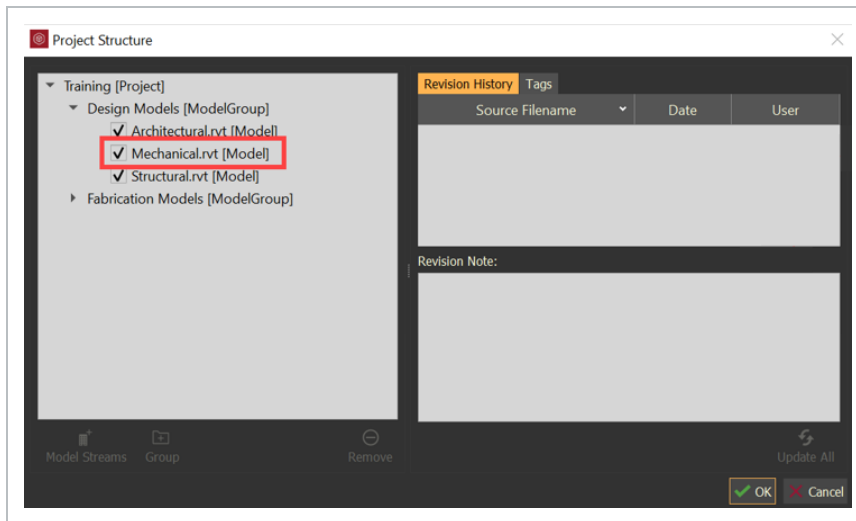

4.4 MODEL STREAM PERMISSIONS

Permissions can be set at the Group level within the Project Structure. Nested groups inherit parent group permissions.

NOTE By default, group permissions inherit project permission for users and user groups.

For best practice, only apply User Groups to projects instead of individual users. This minimizes the management of applying permissions to Model Streams.

4.4 STEP BY STEP 1 – APPLY PERMISSIONS TO GROUPS

1. Open the Project Structure dialog box.
2. Right-click on a group and select **Edit Group Permissions**.

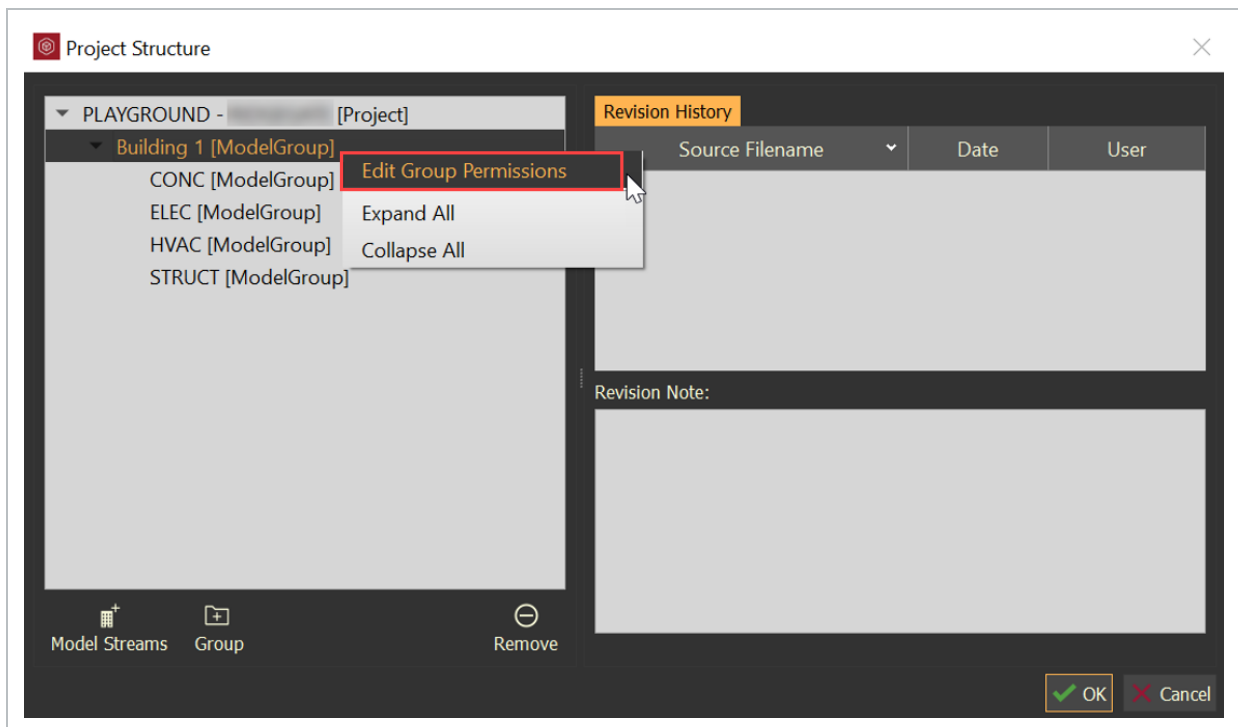

- The Edit Model Group Permissions dialog box opens.
 - By default, the User Parents Group Permissions is already checked.
3. Uncheck the **Use Parent Group Permissions** check box to apply specific User Group permissions.

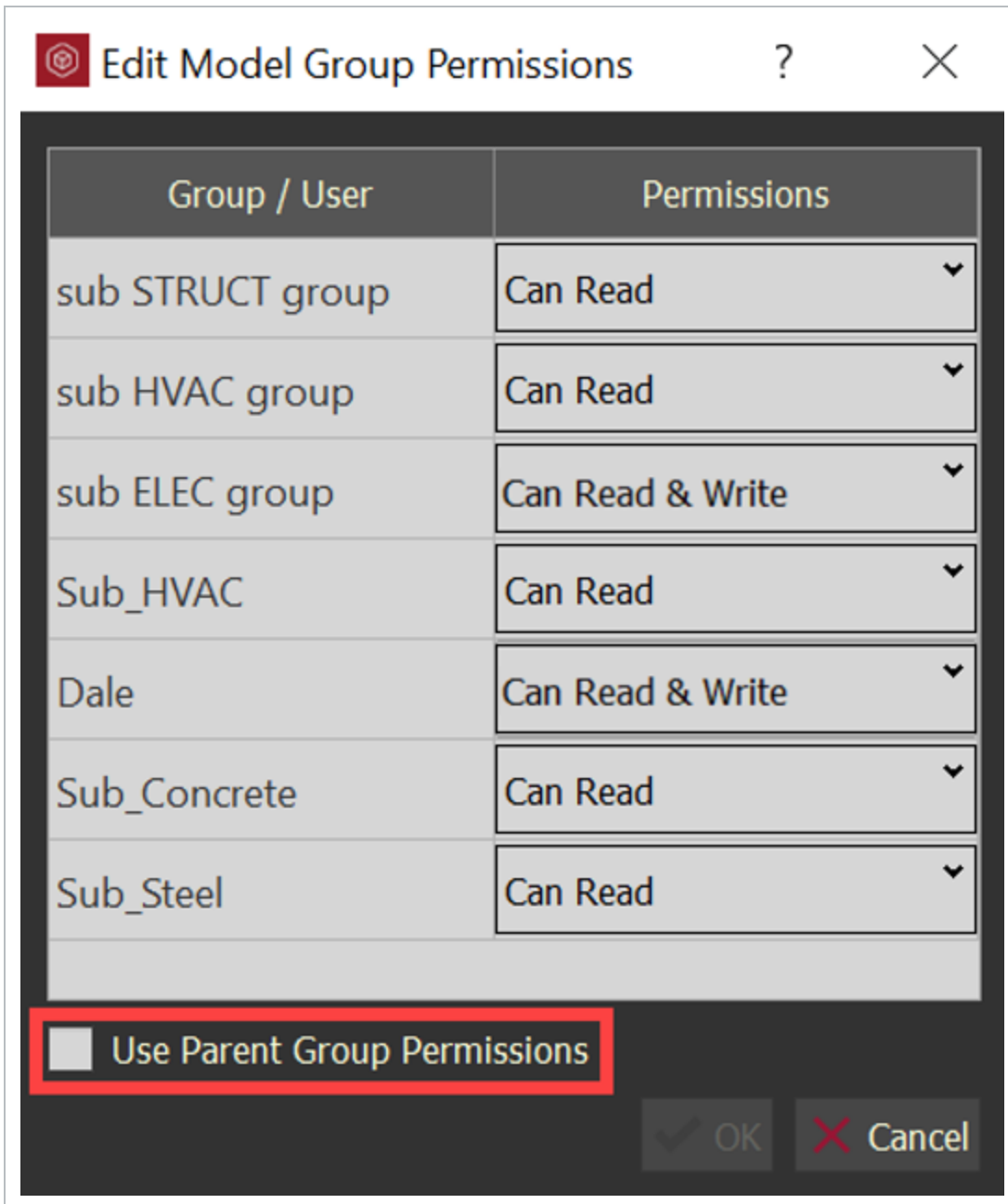

- All users and User Groups show if they have been assigned to the project.
4. Users and User Groups can only have one of the following permissions:
- **Can Read** – read-only permissions.
 - **Can Read and Write** – read, write, and edit permissions.

5. Users that have been assigned to the project within a Group have the **Can Read** permission in the Edit Model Group Permissions dialog box.
 - User Groups that display the project permissions are currently only set at the project level.
6. Use the Account Manager dialog box to reference the users assigned to Groups in specific projects.

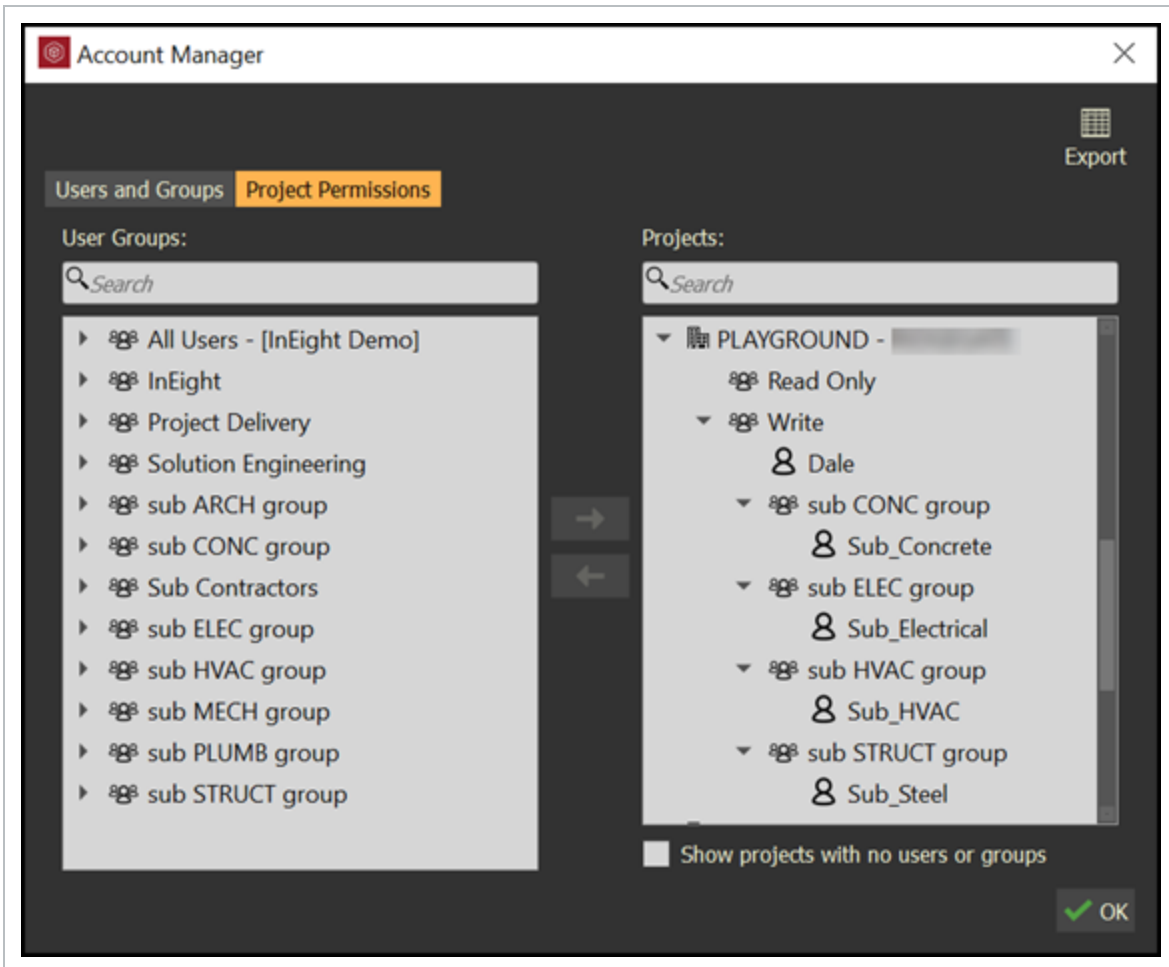

- For more information on the Account Manager dialog box, reference the Managers Users and Manage User Groups topics.
7. Set the permissions for the selected group or user.
 8. Log in as the specific user or group to publish a model.

LESSON 4 REVIEW

1. In the Project Structure tree, groups can only be created before model streams are added.
 - a. True
 - b. False

2. Once a group name has been created, it cannot be edited or renamed.
 - a. True
 - b. False

LESSON 4 SUMMARY

As a result of this lesson, you can:

- Navigate the project structure panel
- Create and delete model stream groups
- Change active model stream revision and revise model stream revision
- Disable and remove model streams
- Add model streams from other projects

This page intentionally left blank.

CHAPTER 5 – USER INTERFACE

5.1 VIEWER INTERFACE

The Viewer interface (Workspace) is highly configurable. Tools and panels are accessed through a series of menus located across the top of the application and a notification panel located across the bottom of the application.

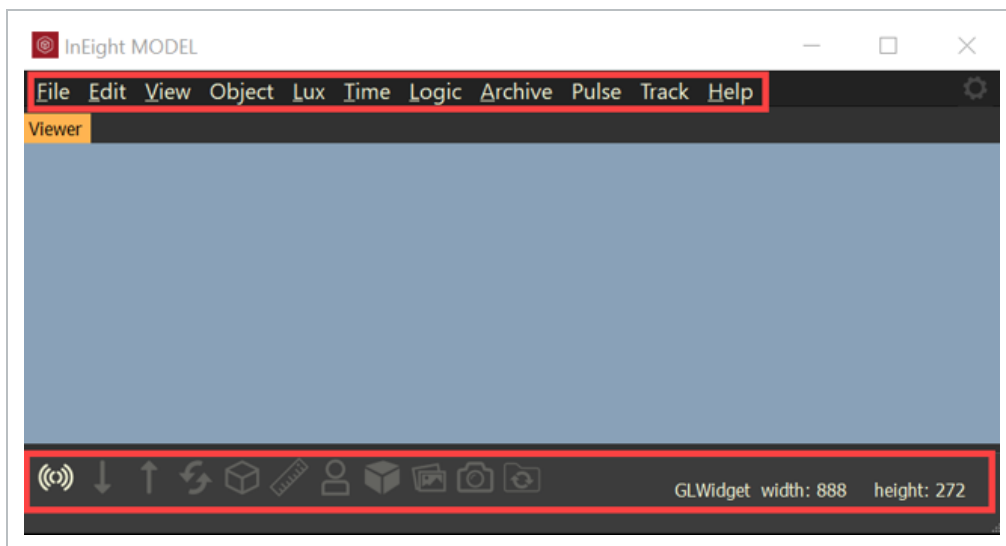

Panels can be opened, closed, rearranged, and docked into various configurations. Move, dock and undock panels by dragging the panel title bar.

TIP

Hold Ctrl before dragging a panel to prevent it from docking automatically.

- Some Panels have multiple areas, differentiated with tabs:
- When panels are docked on top of one another, each panel is represented as a tab
- Tabs can be on top, side of, and bottom of a panel
- Select the tab to activate a specific panel or area of a panel
- The active panel tab is highlighted in orange
- Re-size undocked panels by clicking and dragging the panel edge

- Resize a docked panel by clicking and dragging the edge of the panel

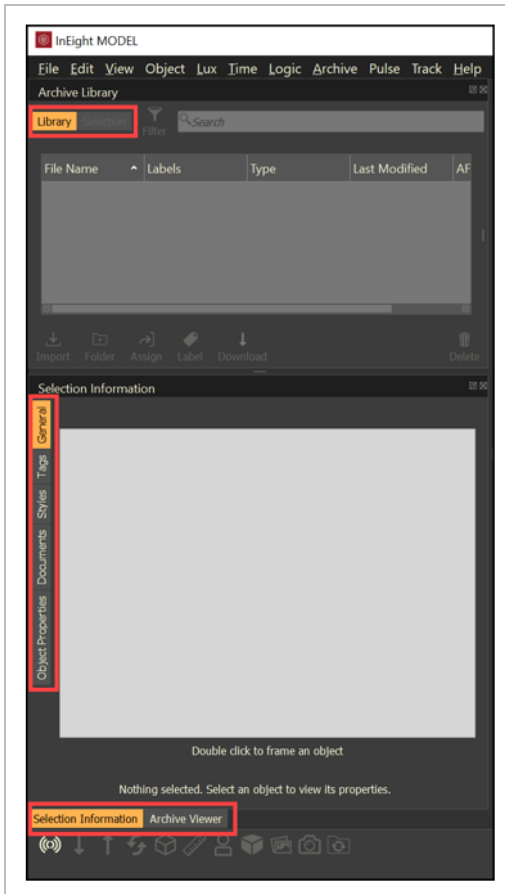

5.1.1 DOCKING PANELS:

- While moving a panel to dock at the Top, Bottom, Left or Right, the Viewer will respond by indicating a space for the panel to be docked

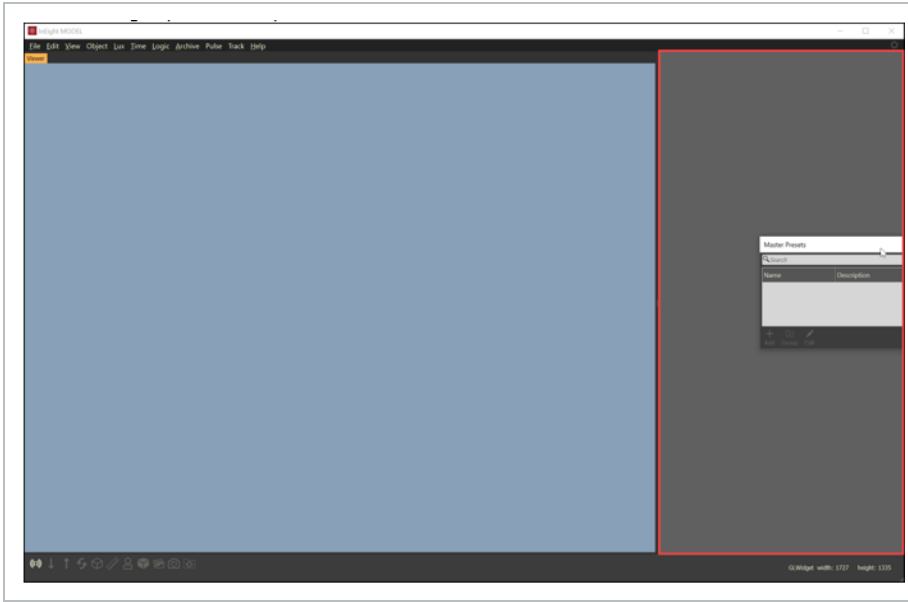

- Panels can be docked at the Top, Bottom, Right, and Left of the viewer

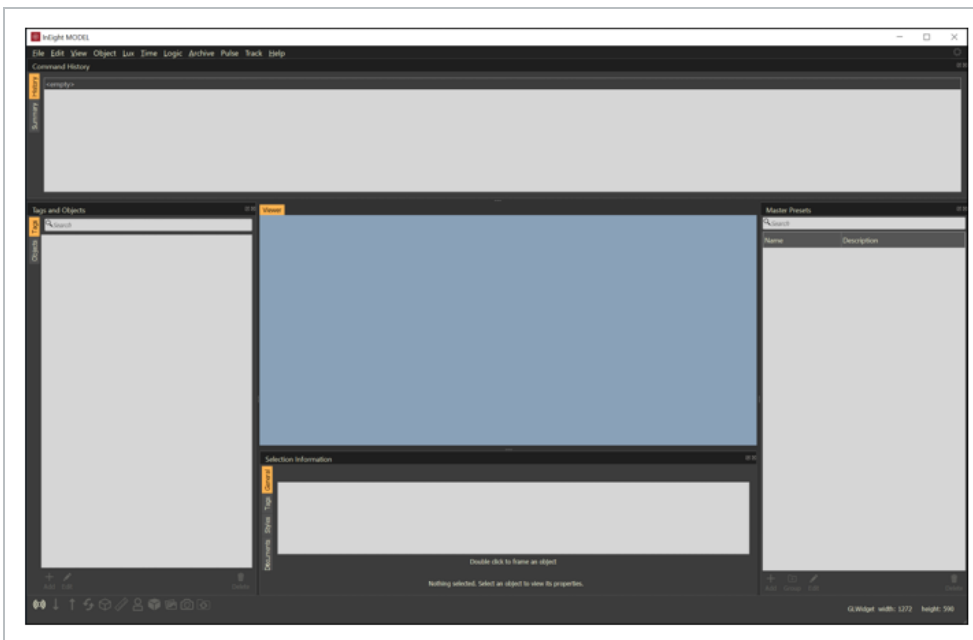

- Panels can be docked on top of one another

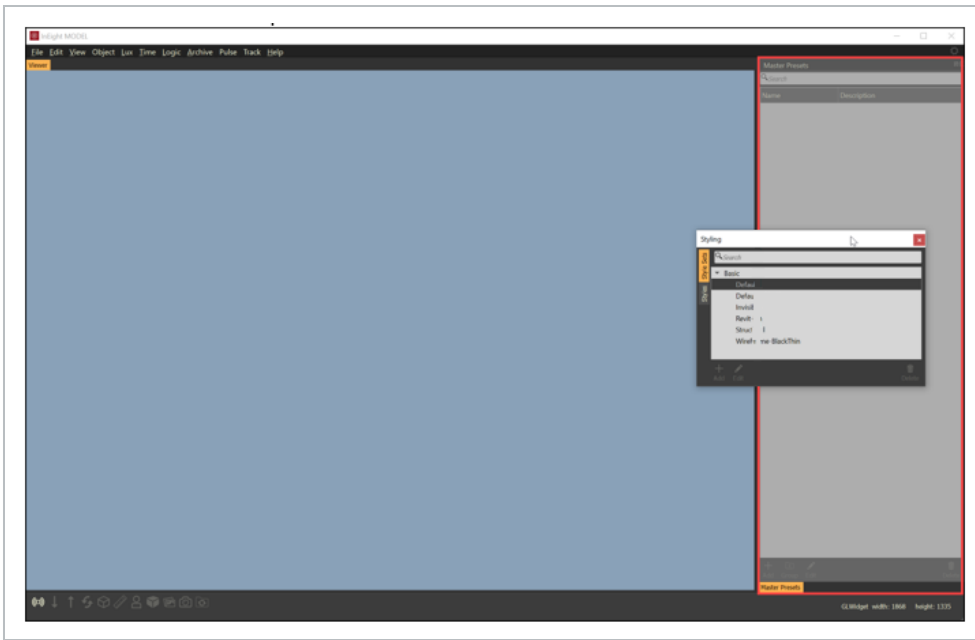

- Panels can be docked at the top or bottom of another panel

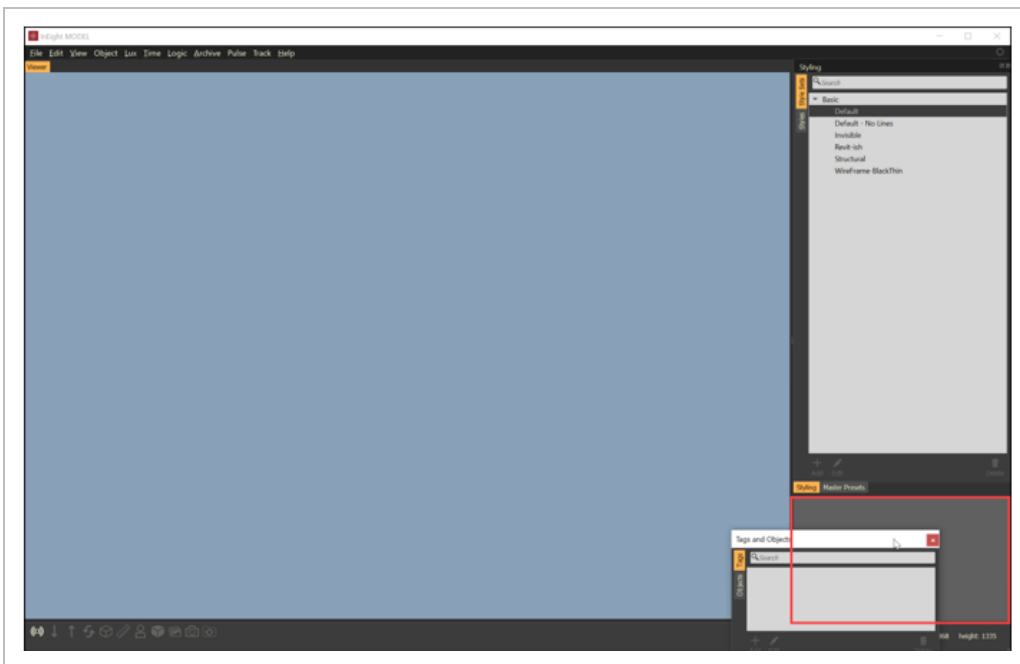

- Panels can be docked beside another panel

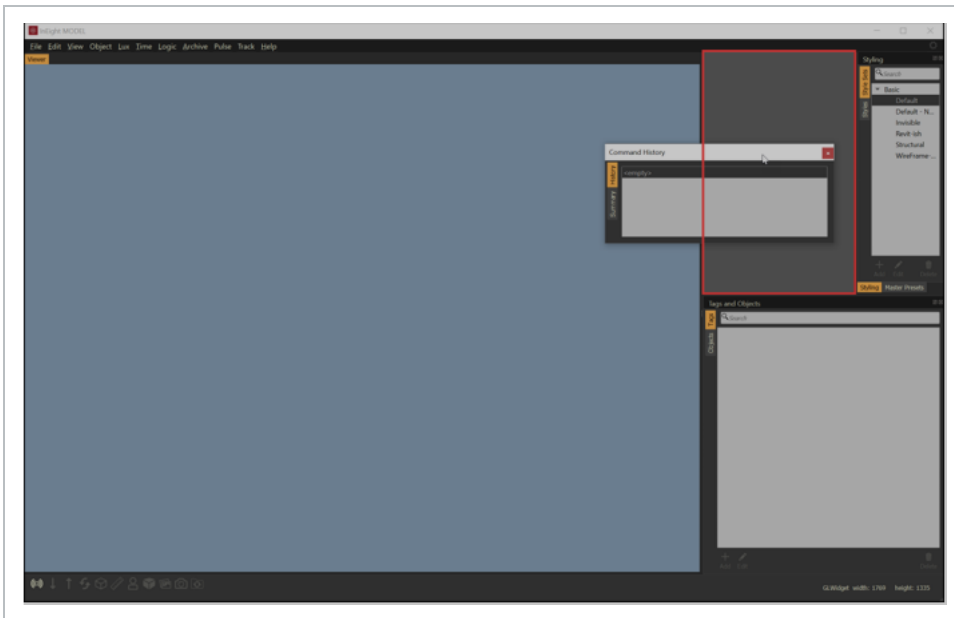

- Panels can be docked in between two panels

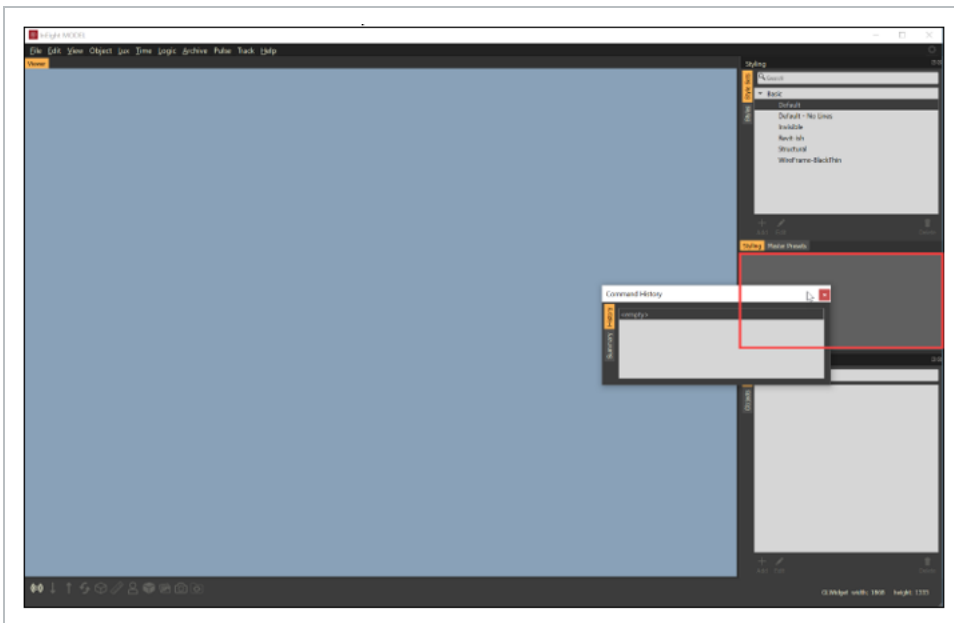

- Panels can be stand alone on the same or different monitor

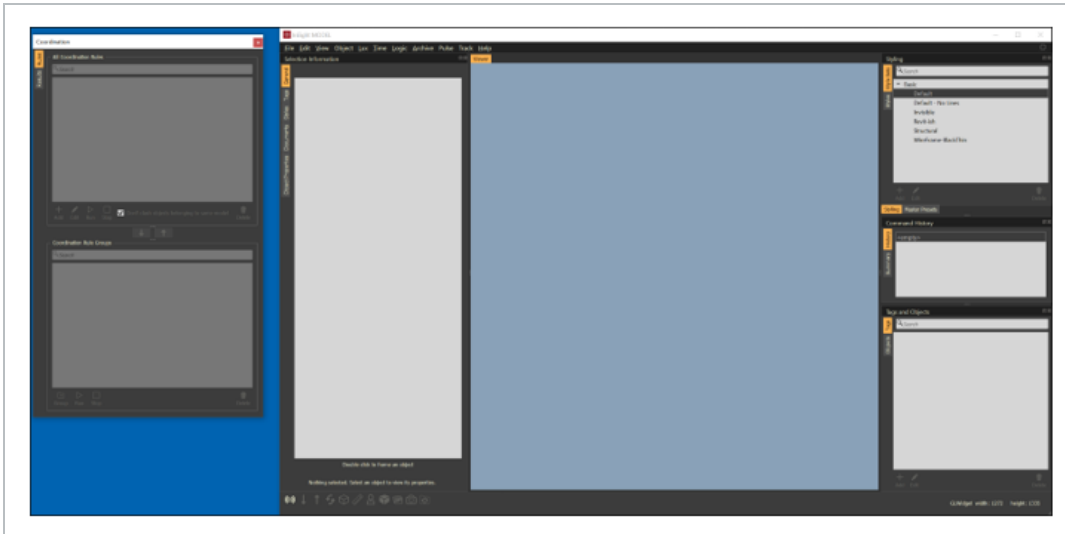

5.2 SHOW MODEL SPOTS

Model Spots provide the ability to easy find those model streams that are not aligned on the same coordinate.

5.2 STEP BY STEP 1 – SHOW MODEL SPOTS

1. Select View > Show Model Spots.

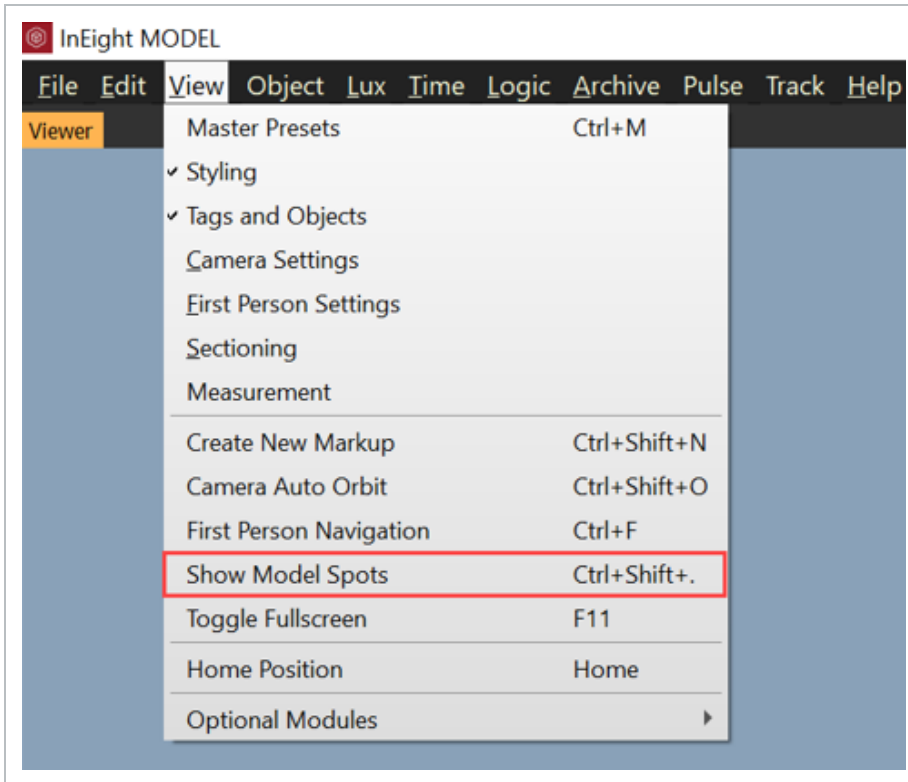

2. Zoom out until red dots are visible or click the Home key on the keyboard.



3. Hover over a dot to see the model stream name(s).

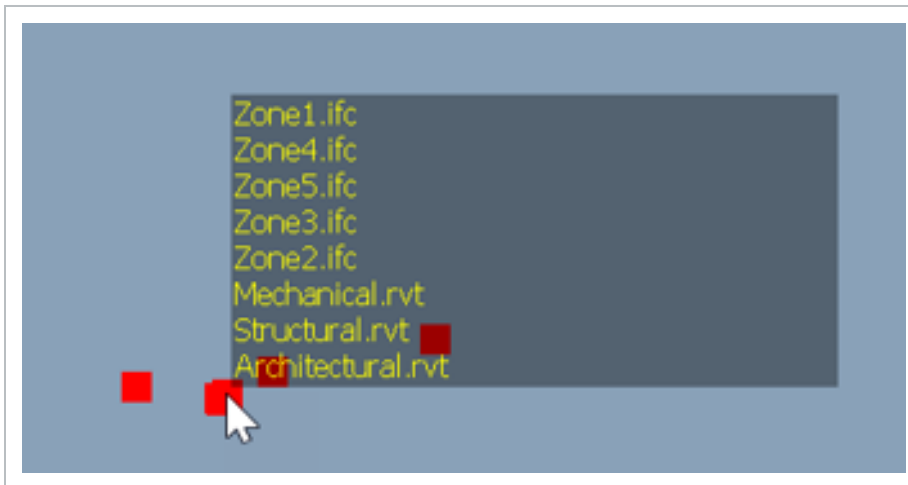

4. Double-click on a model spot to zoom into the model stream(s).

5.3 NAVIGATION

InEight Model allows you to move through, zoom, pan, and change perspectives within the 3D space surrounding your model. To begin, load or open a model. The navigation widget will appear in the top, right corner of your window and will rotate as you navigate to indicate your camera's position and direction in space.

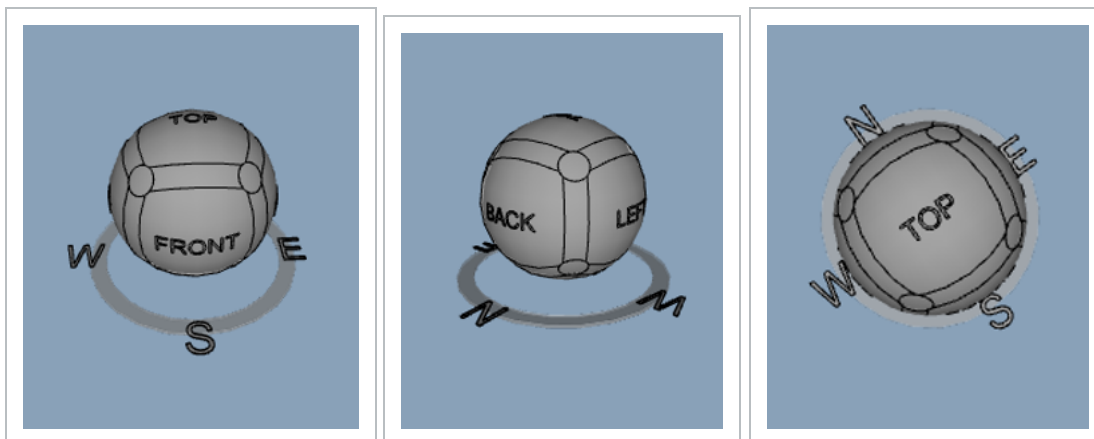



NOTE If the navigation widget is not present in the top, right corner of your screen, there is nothing to navigate; load a model.

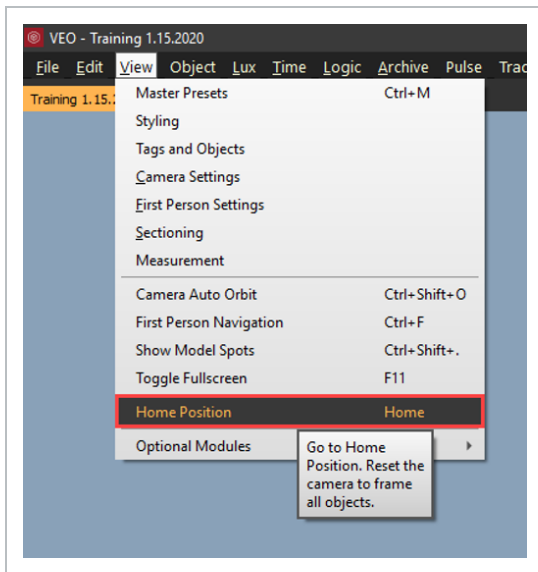

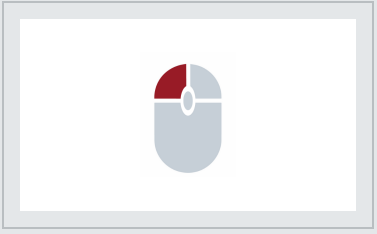

In InEight Model, the viewer interaction is focused on the center of the view and not the model objects. This allows you to see all objects from your camera perspective as you navigate and interact with objects. To quickly return to the designated “home” view of a model, you can navigate up to the menu, click View, and select **Home Position** from the drop-down menu.



Navigation Controls

Function	Action	Description
Orbit		Left click and hold to revolve around, or orbit, the object or model
Pan		Right click and hold to maintain the object’s position while moving, or panning, your view of the object or model

Navigation Controls (continued)

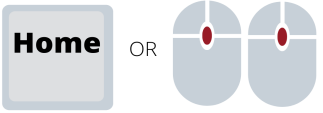
Function	Action	Description
Zoom (to Center of view)		Scroll the wheel away from you to zoom in and toward you to zoom out
Zoom to Cursor		Hold the CTRL key and use the scroll wheel to zoom to, and away from, the cursor. Your cursor must be over a model element
Zoom to Object / Set Center		Double left click an object to zoom the camera to an object. This will set the center of orbit to the object
Zoom to Selected Objects		Select an object and press the F5 key to zoom the camera to frame the selection
Zoom to Home Position		Use the Home key or double click the mouse wheel to zoom the camera to frame the extents and home position of the 3D environment

Navigation Controls (continued)

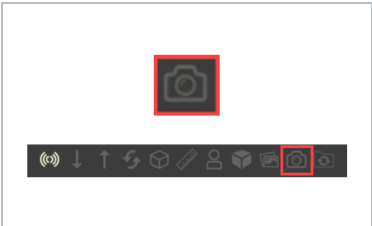
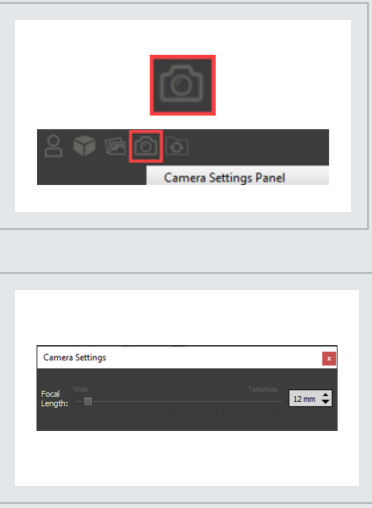

Function	Action	Description
<p>Orthographic & Perspective Views</p>		<p>Toggle between the Orthographic and Perspective view modes</p>
<p>Camera Settings (Perspective View)</p>		<p>Camera Settings enable you to change the focal length of the lens through which you are viewing the model . Right click on the camera icon and click Camera Settings Panel to adjust your setting. This setting is only available in Perspective View</p>

5.3.0.1 FIRST PERSON NAVIGATION

First person navigation positions the camera view where it assumes your eyes would be and what they would see in relationship to the model environment.

<p>First Person Toggle</p>		
----------------------------	---	--

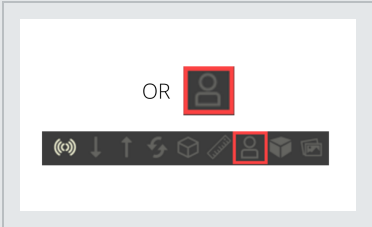
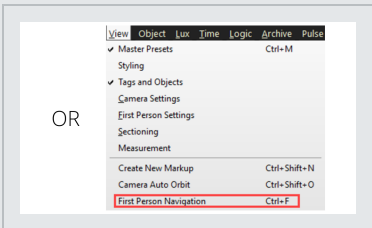
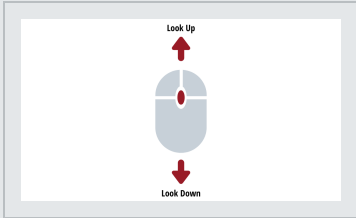
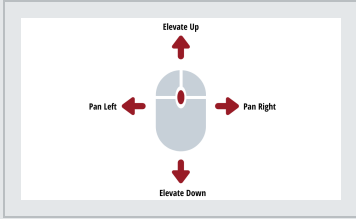
Navigation Controls (continued)

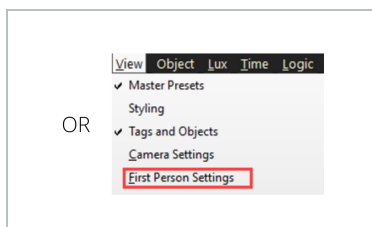
Function	Action	Description
	 	 
<p>Walk Speed</p>	 	<p>Walk Speed enables you to change the speed up or slow down when walking through the model</p>



5.4 SELECTION

InEight Model allows you to manipulate the way you view, manage, and interact with the objects that make up your model(s). Many of these features are available as hot keys and within a drop-down menu.

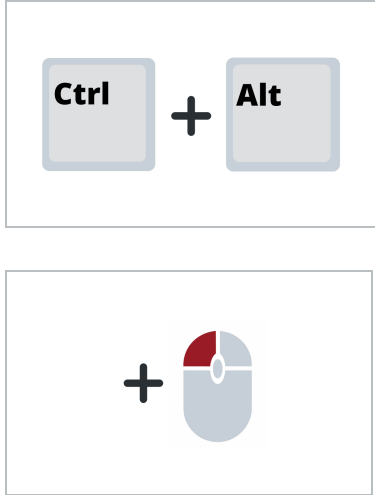
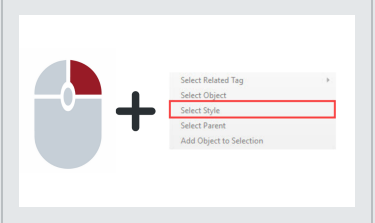

Selection Controls

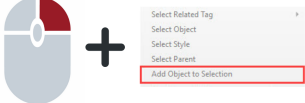
Function	Action	Description
Select Object		Allows you to select an object
Select Object Transparent		Allows you to select transparent objects
Select Style		Provides a means to select like objects with the same style (enabled only if one object is selected)

Selection Controls (continued)

Function	Action	Description
<p>Add / Remove to Selection</p>	<div data-bbox="522 308 889 533">  </div> <div data-bbox="522 567 889 791">  </div> <p style="text-align: center;">OR</p> <div data-bbox="522 867 889 1092">  </div>	<p>Adds unselected objects to the current selection set, or, removes selected objects from the existing selection set</p>
<p>Window Selection</p>	<div data-bbox="522 1148 901 1373">  </div> <div data-bbox="522 1423 901 1648"> <p style="text-align: center;">DRAW A + WINDOW TO THE RIGHT</p> </div> <p style="text-align: center;">OR</p>	<p>Selects objects completely within the window</p>

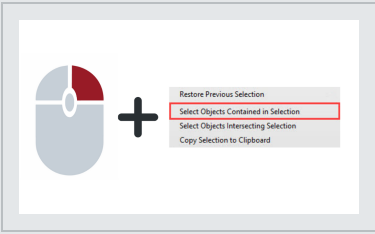
Selection Controls (continued)

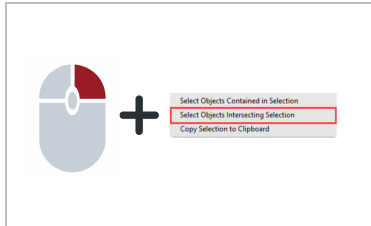
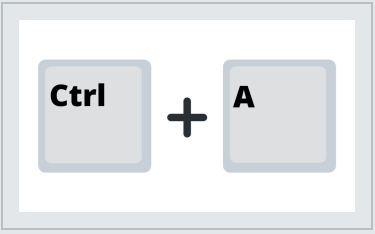
Function	Action	Description
		
<p>Crossing Selection</p>	<div data-bbox="521 611 889 835">  </div> <div data-bbox="521 867 889 1094"> <p>DRAW A WINDOW TO THE LEFT</p> </div> <p>OR</p> <div data-bbox="521 1178 889 1402">  </div>	<p>Selects objects that are both completely in the window and those that cross into the window</p>
<p>Select All</p>		<p>Initiates the select all action. A dialog box will appear to confirm this action</p>

Selection Controls (continued)

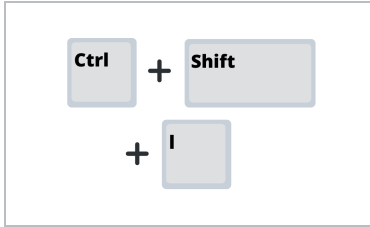
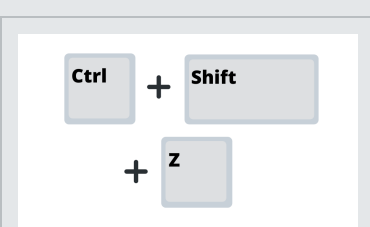
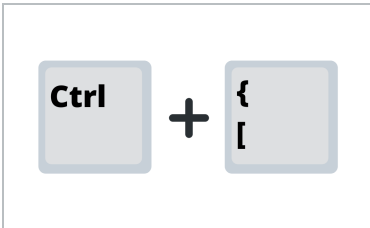
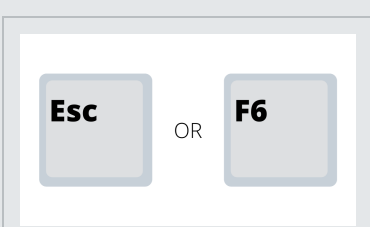
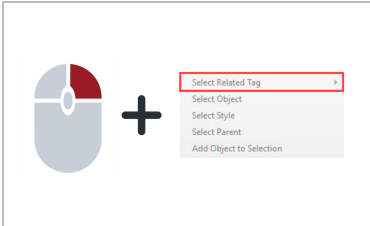
Function	Action	Description
<p>Invert Selection</p>		<p>Inverts the selection set of objects</p>
<p>Restore Previous Selection</p>		<p>Restores the selection set to the previous selected objects</p>
<p>Selection Filter</p>		<p>Opens the Selection Filter dialog box and allows you to filter down the selection set</p>
<p>Clear Selection</p>		<p>Clears the current selection</p>
<p>Select Related Tag</p>		<p>Provides a means to select like objects with the same tag</p>

Selection Controls (continued)

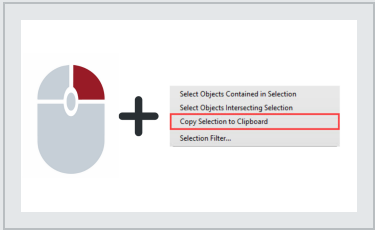
Function	Action	Description
Copy Selection to Clipboard		Provides a means to copy the select object's metadata to the clipboard

Right Click Menu Selection Controls

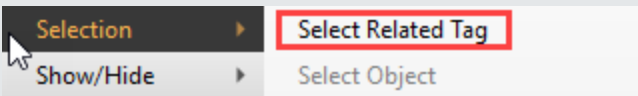
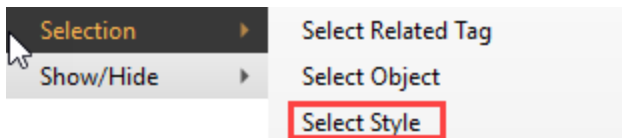
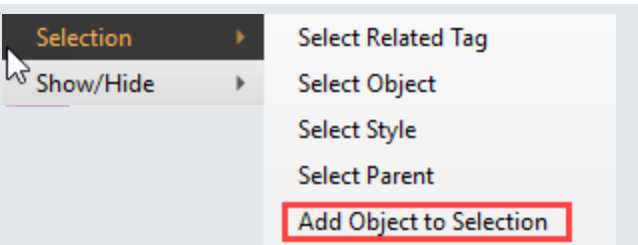
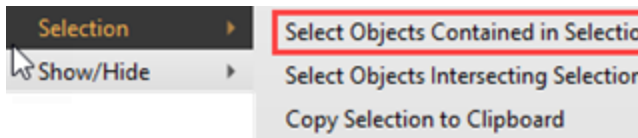
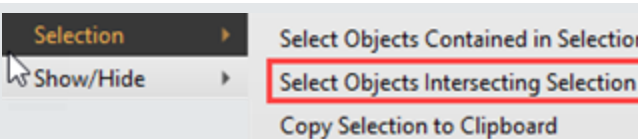
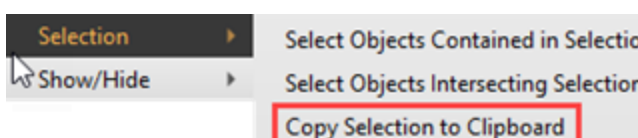
Function	Action	Description
RCM - Select Object		Right click on top of an object, then click Select Object
RCM – Select Related Tag		Provides a means to select like objects with the same tag.
RCM – Select Style		Provides a means to select like objects with the same style. (Note: enabled only if one object is selected)
RCM – Add Object to Selection		Right click on top of an object, then click Add Object to Selection
RCM – Select Objects Contained in Selection		Provides a means to select all objects contained within the object
RCM – Select Objects Intersecting Selection		Provides a means to select all objects inside and intersecting with an object
RCM – Copy Selection to Clipboard		Provides a means to copy the selected object’s metadata to the clipboard

5.4.0.1 RIGHT CLICK MENU

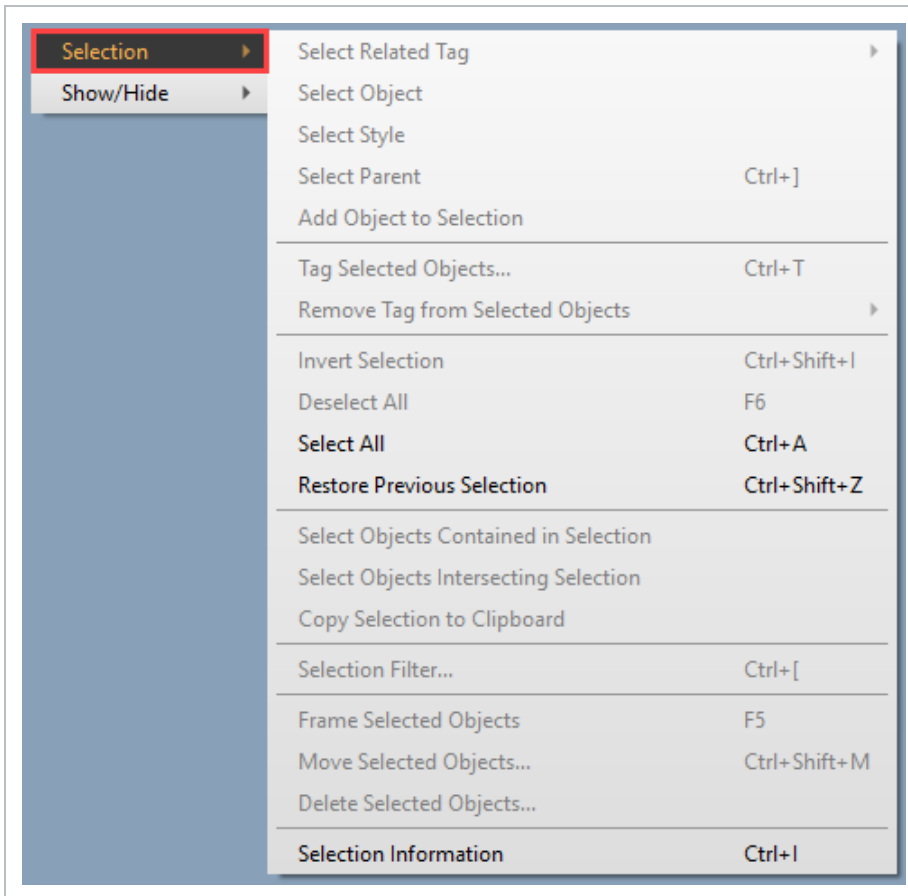

- The Selection Menu offers all the selection commands listed in the table above, except **Delete Selected Objects** and **Copy Selection to Clipboard** (see the table above for descriptions)



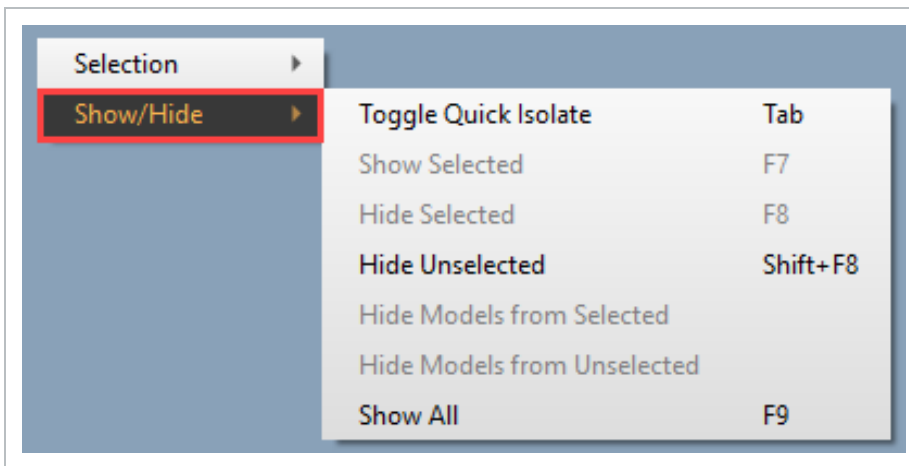

- The Show/Hide Menu offers even more options – many of which are also accessible as hot keys. See the table below for descriptions

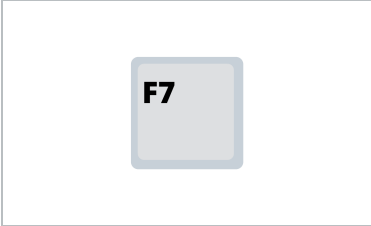

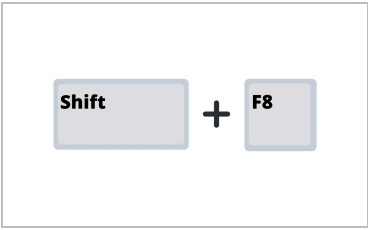
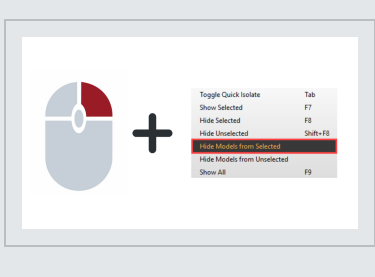
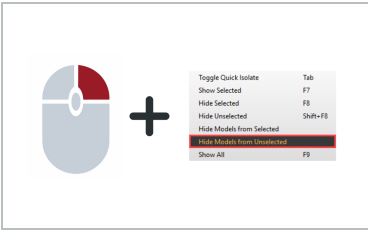

Model Object View Controls

Function	Action	Description
Isolate Mode		Toggles between the entire model and an isolated view of the selected objects
Show Selected		Shows all selected objects
Hide Selected		Hides all selected objects

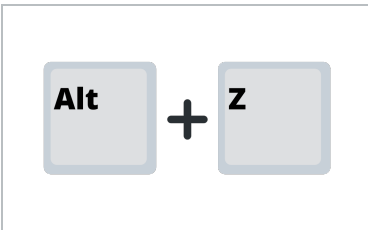
Model Object View Controls (continued)

Function	Action	Description
Hide Unselected		Hides all unselected objects
Hide Models from Selected		Hides all models from the selected objects
Hide Models from Unselected		Hides all models from the unselected objects
Show All		Shows all objects and models in a project
Undo View State Changes		Undo up to the last 10 view state changes

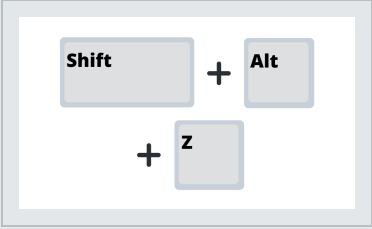
Model Object View Controls (continued)

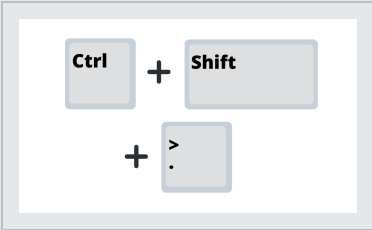
Function	Action	Description
Redo View State Changes		Redo up to the last 10 view state changes
Toggle Full Screen		Toggles the window size and position between a customizable (F11) and full screen window
Show Model Spots		Marks the model's spot within the space so that the model is identifiable no matter how far out you zoom

5.5 SELECTION MODE

Selection Mode provides the ability to select objects related to the active mode.

- Last Object will select the lowest level of an object (a child)
- First Object will select all objects that belong to the highest level (a parent)
- IWP will select all objects that belong to the IWP associated to the object being selected
- CWP will select all objects that belong to the CWP associated to the object being selected
- Elements will select objects that belong to the Element associated to the object being selected
- Tag Name will select objects that belong to the Tag associated to the object being selected

NOTE Any object can be selected no matter what mode is active. If the object selected does not have data associated to it for the active mode, then the Last Object mode will be the default.

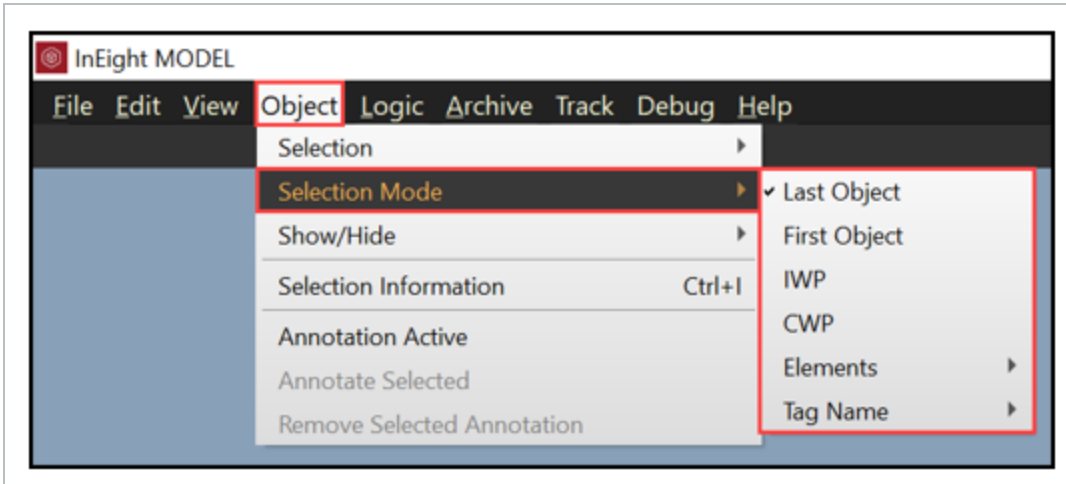

5.5.1 SELECTION MODE INDICATOR

Selection Mode is always active and will be displayed at the bottom right within the viewer.

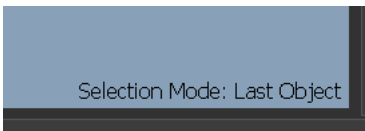

5.5.2 SELECTION MODE - LAST OBJECT

Last Object selection mode will select the lowest level of the object.

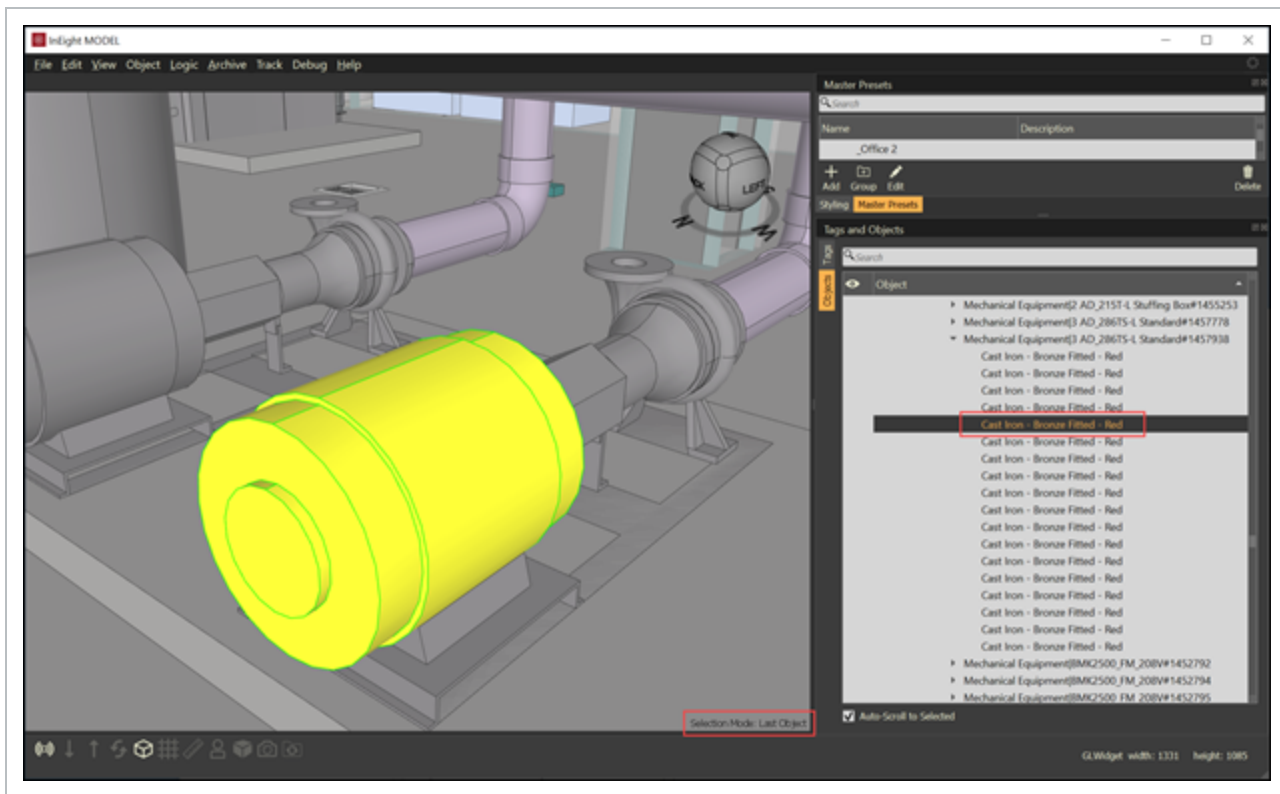

5.5.3 SELECTION MODE - FIRST OBJECT

First Object selection mode will select the highest level of the object and select all objects associated to the parent level.

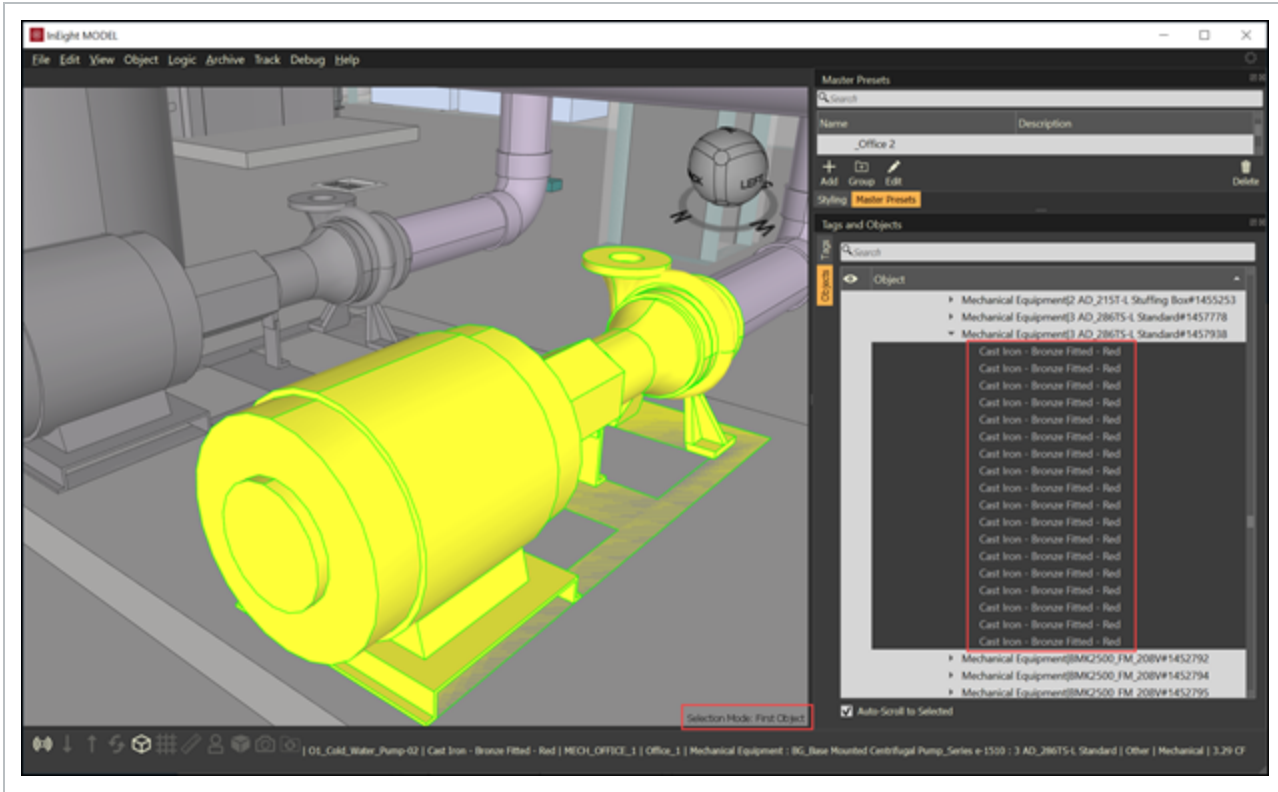

5.5.4 SELECTION MODE - IWP

IWP selection mode will select all objects that belong to the IWP associated to the object being selected.

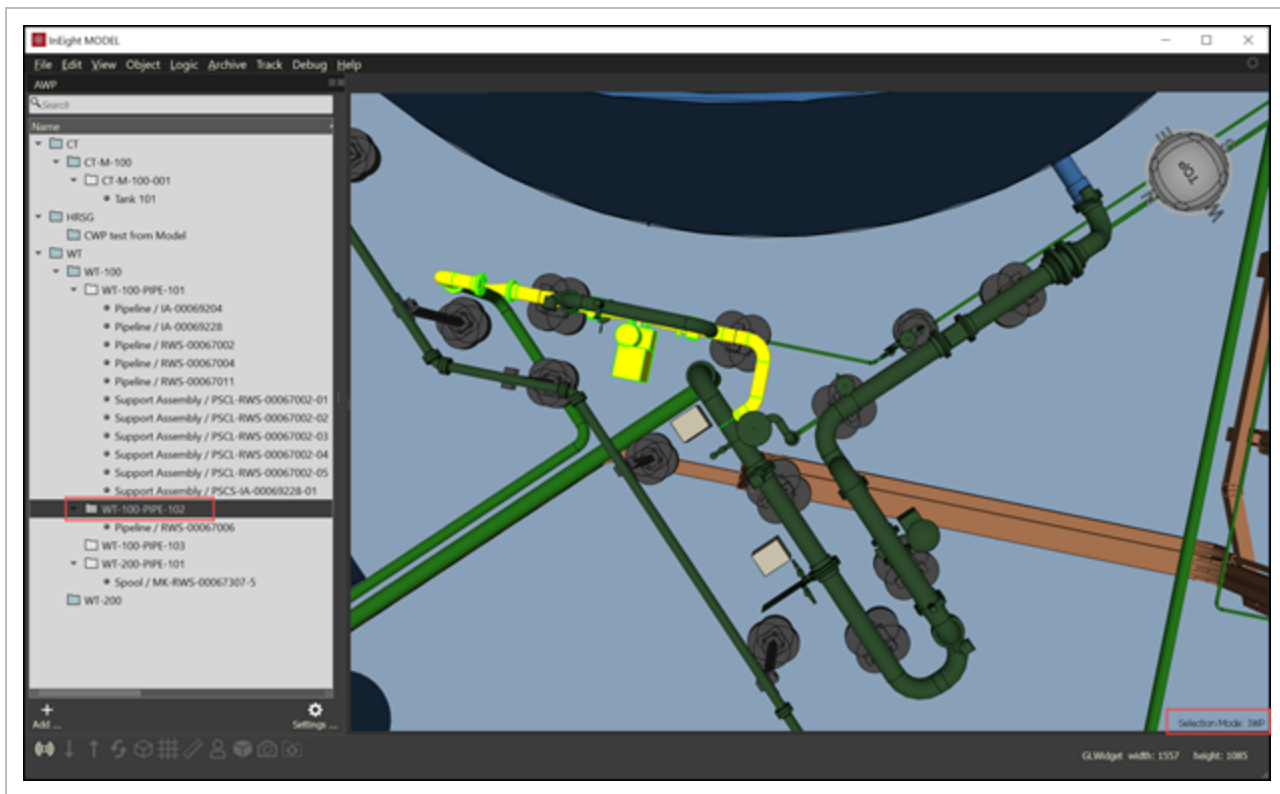

5.5.5 SELECTION MODE - CWP

CWP selection mode will select all objects that belong to the CWP associated to the object being selected.

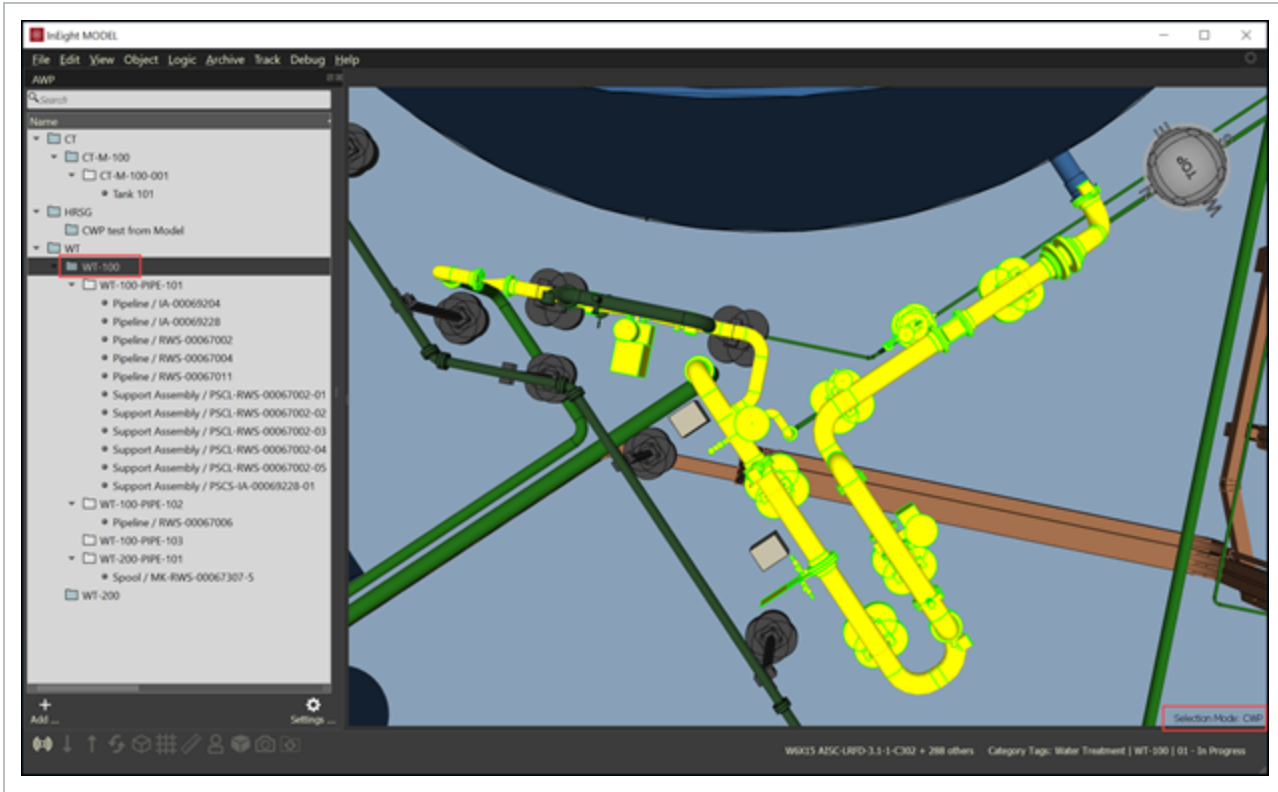

5.5.6 SELECTION MODE - ELEMENT

Element selection mode will select all objects that belong to the Element associated to the object being selected.

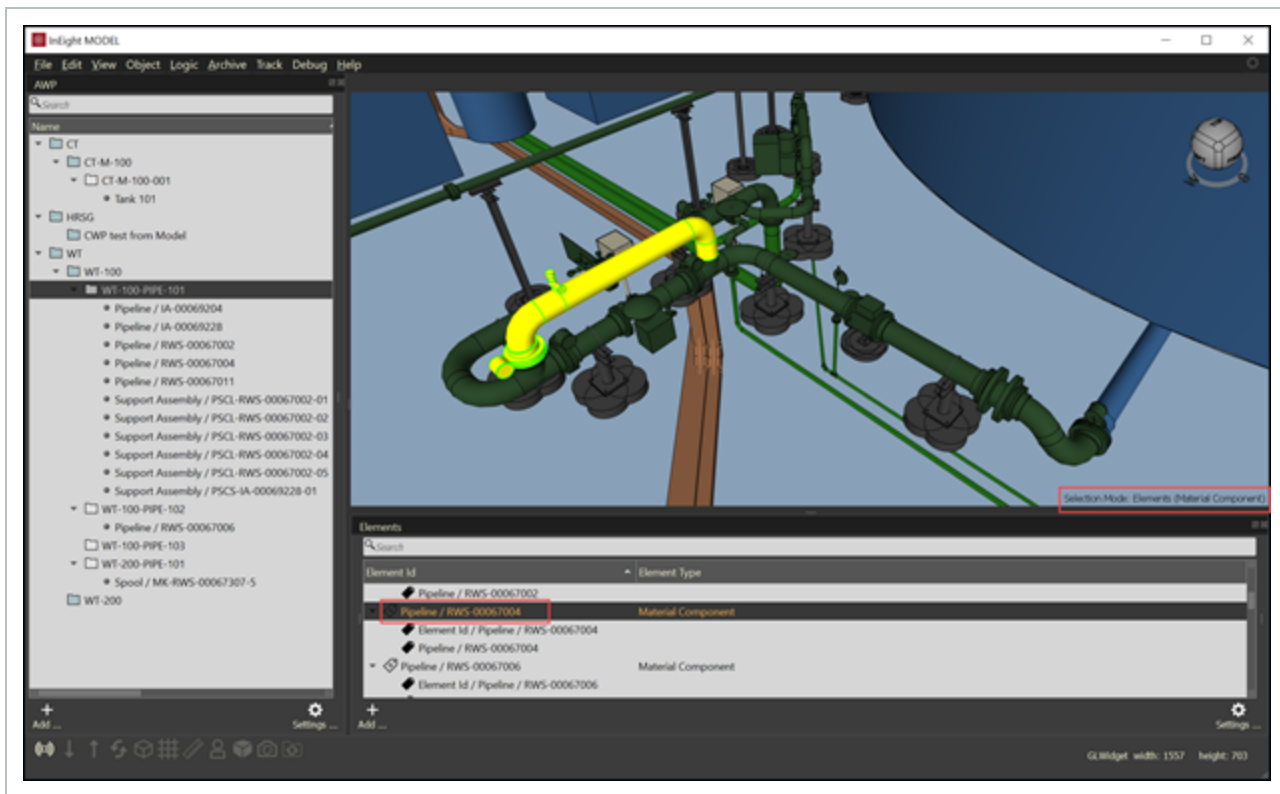

5.5.7 SELECTION MODE - TAG

Tag selection mode will select all objects that belong to the Tag associated to the object being selected.

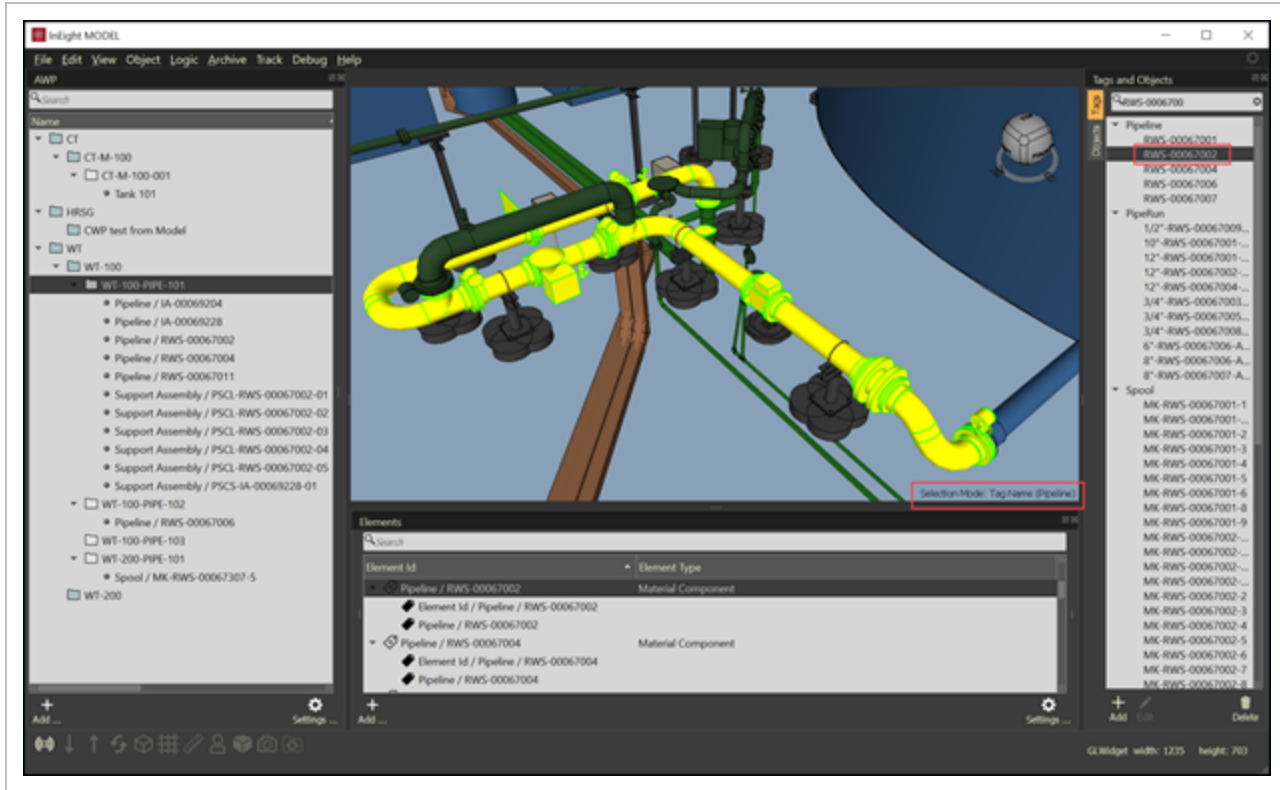





5.6 HOT KEYS

[Click to open a one page PDF copy of the InEight Model Hot Keys.](#)

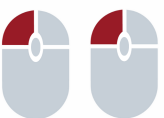

Viewer Navigation

Function	Action	Description
Orbit		Left click and hold to revolve around, or orbit, the object or model

Viewer Navigation (continued)

Function	Action	Description
Pan		<p>Right click and hold to maintain the object's position while moving, or panning, your view of the object or model</p>
Zoom (to center of view)		<p>Scroll the wheel away from you to zoom in and toward you to zoom out</p>
Zoom to Cursor		<p>Hold the CTRL key and use the scroll wheel to zoom to, and away from, the cursor. Your cursor must be over a model element</p>
Zoom to Object / Set Center		<p>Double left click an object to zoom the camera to an object. This will set the center of orbit to the object</p>
Zoom to Selected Object		<p>Select an object and press the F5 key to zoom the camera to frame the selection</p>

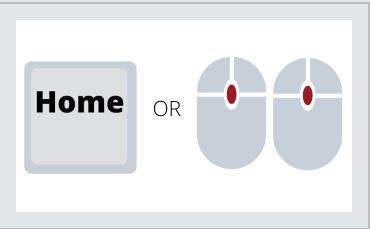
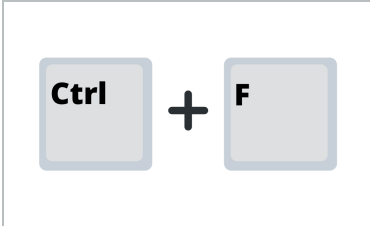
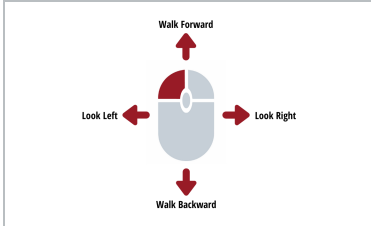
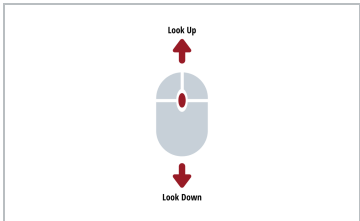
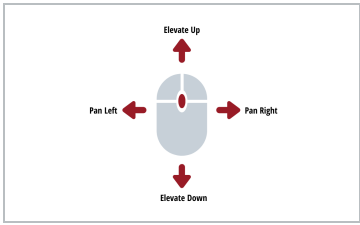
Viewer Navigation (continued)

Function	Action	Description
Zoom to Home Position		<p>Use the Home key or double click the mouse wheel to zoom the camera to frame the extents and home position of the 3D environment</p>
First Person Toggle		
		
		
Adjust Walk Speed		<p>Walk Speed enables you to change the speed up or slow down when walking through the model</p>

Model Object Selection

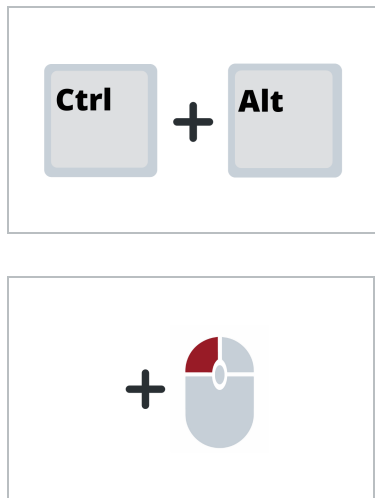
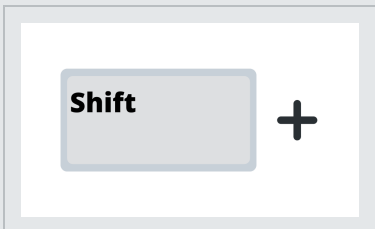
Function	Action	Description
Select Object	 <p>The diagram shows two alternative actions for selecting an object. The first action is pressing the Alt key followed by clicking the mouse button. The second action is clicking the mouse button followed by opening a context menu. The context menu is shown with the following options: Select Related Tag, Select Object (highlighted with a red border), Select Style, Select Parent, and Add Object to Selection.</p>	Allows you to select an object
Select Transparent Object	 <p>The diagram shows two alternative actions for selecting a transparent object. The first action is pressing the Ctrl and Alt keys together. The second action is clicking the mouse button.</p>	Allows you to select transparent objects
Add / Remove to Selection	 <p>The diagram shows the action for adding or removing objects from the selection set, which is pressing the Shift key followed by clicking the mouse button.</p>	Adds unselected objects to the current selection set, or, removes selected objects from the existing selection set

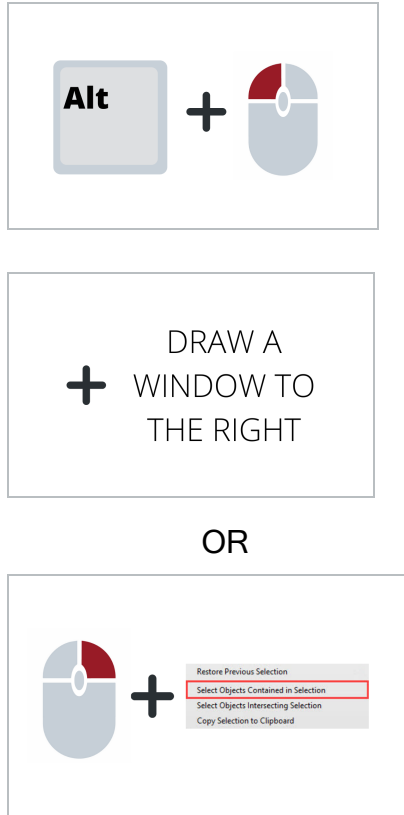

Model Object Selection (continued)

Function	Action	Description
		
<p>Window Selection</p>		<p>Selects objects completely within the window</p>

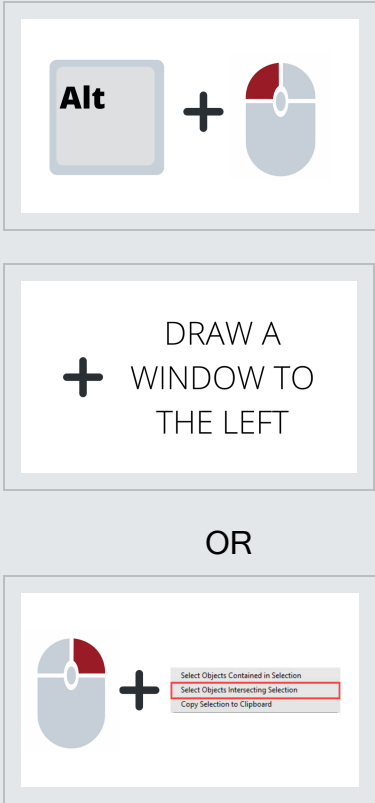
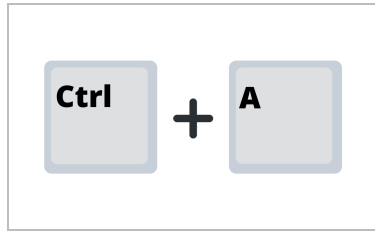
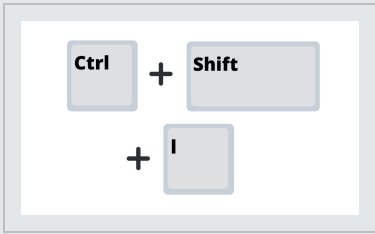
Model Object Selection (continued)

Function	Action	Description
<p>Crossing Selection</p>	 <p>The diagram shows the 'Alt' key icon followed by a plus sign and a mouse icon. Below this is a box containing the text 'DRAW A WINDOW TO THE LEFT'. Underneath that is the word 'OR', followed by another mouse icon plus a plus sign and a context menu with three options: 'Select Objects Contained in Selection', 'Select Objects Intersecting Selection', and 'Copy Selection to Clipboard'.</p>	<p>Selects objects that are both completely in the window and those that cross into the window</p>
<p>Select All</p>	 <p>The diagram shows the 'Ctrl' key icon followed by a plus sign and the 'A' key icon.</p>	<p>Initiates the select all action. A dialog box will appear to confirm this action</p>
<p>Invert Selection</p>	 <p>The diagram shows the 'Ctrl' key icon followed by a plus sign and the 'Shift' key icon. Below this is another plus sign followed by the 'I' key icon.</p>	<p>Inverts the selection set of objects</p>

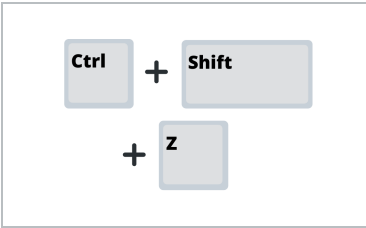

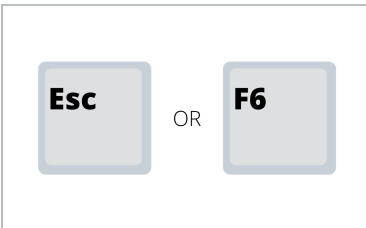

Model Object Selection (continued)

Function	Action	Description
Restore Previous Selection		Restores the selection set to the previous selected objects
Selection Filter		Opens the Selection Filter dialog box and allows you to filter down the selection set
Clear Selection		Clears the current selection

Model Object View

Function	Action	Description
Isolate Mode		Toggles between the entire model and an isolated view of the selected objects

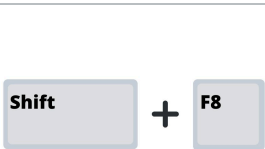

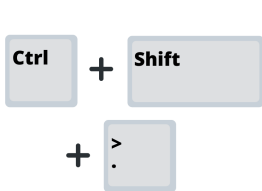
Model Object View (continued)

Function	Action	Description
Show Selected		Shows all selected objects
Hide Selected		Hides all selected objects
Hide Unselected		Hides all unselected objects
Show All		Shows all objects and models in a project
Show Model Spots		Marks the model's spot within the space so that the model is identifiable no matter how far out you zoom

Model Object View (continued)

Function	Action	Description
Toggle Full Screen		Toggles the window size and position between a customizable (F11) and full screen window

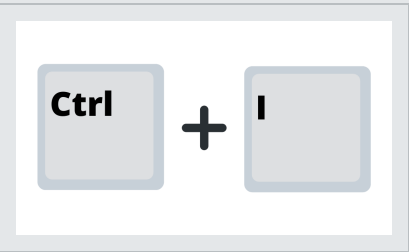
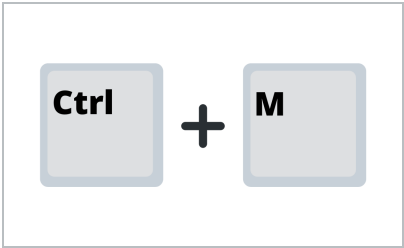
Panels

Function	Action	Description
Selection Information		Opens the Selection Information Panel where you can view the attributes and metadata of your selected objects
Master Presets		Opens the Master Presets Panel where you can quickly select or create a master preset
Coordination		Opens the Coordination Panel where you can quickly run rules and see your results

Panels (continued)

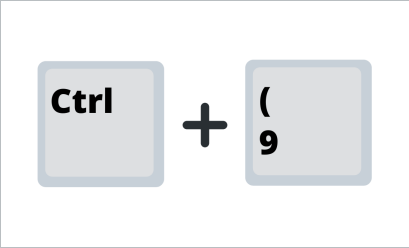
Function	Action	Description
Data Transformation Operations		Opens the Data Transformation Operations Panel

Actions

Function	Action	Description
Tag Selected		Opens the Tag Panel to allow you to select and apply tags to your selected objects

Other

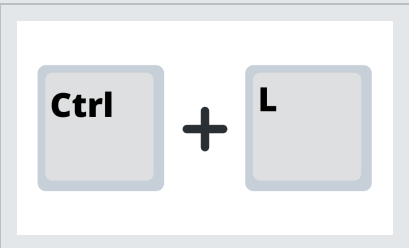
Function	Action	Description
Load Project		Opens the Load Model Project Dialog Box where you can quickly load additional models

Other (continued)

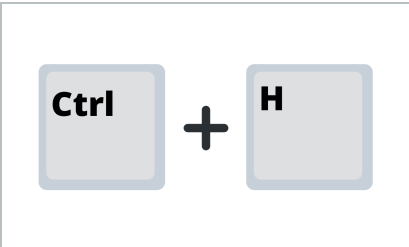
Function	Action	Description
Command History		Opens the Command History Panel where you can view any and all saved changes

5.7 USER SETTINGS

Within the Settings icon in the top left of the menu bar, a user can modify their user settings. Toggle to:

- Work Online/Offline
- Adjust User Settings
- Change Password
- Edit Contact Information
- Save Workspaces
- Reset Workspace

- administrators can access User Management through Admin

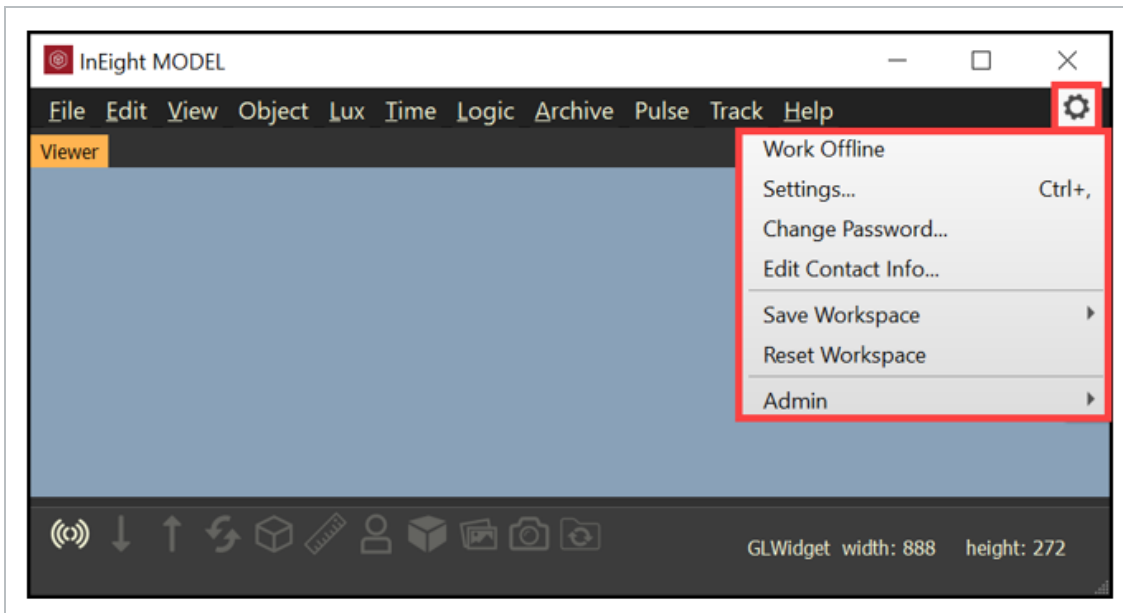

5.7.1 SETTINGS...

Provides the ability to change:

- Mouse/Keyboard Mapping changes
- Choose Default Zoom Behavior
- Set the Coordinate Display Units
- Change the Background Color
- Choose Selection Display Style

- Invert Scroll Wheel in First Person

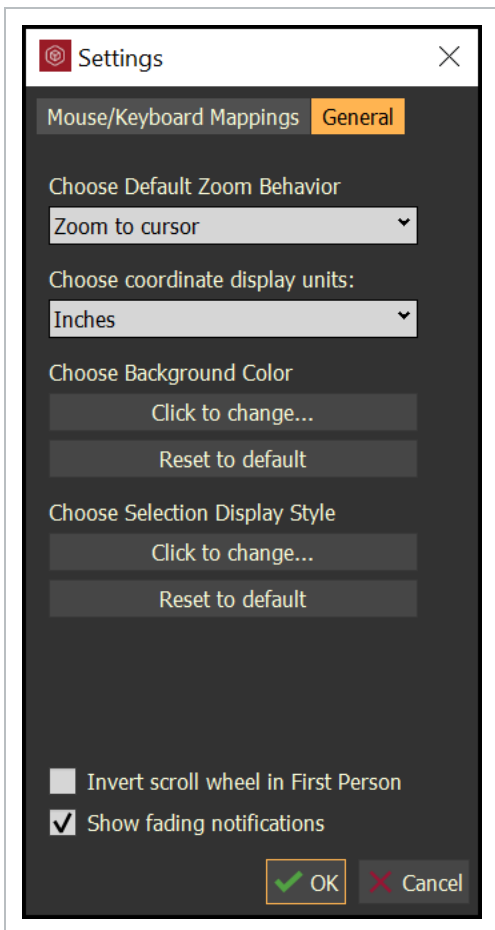

5.7.2 MOUSE / KEYBOARD MAPPING

Allows for the user to change any of the shortcuts to their working experience desire

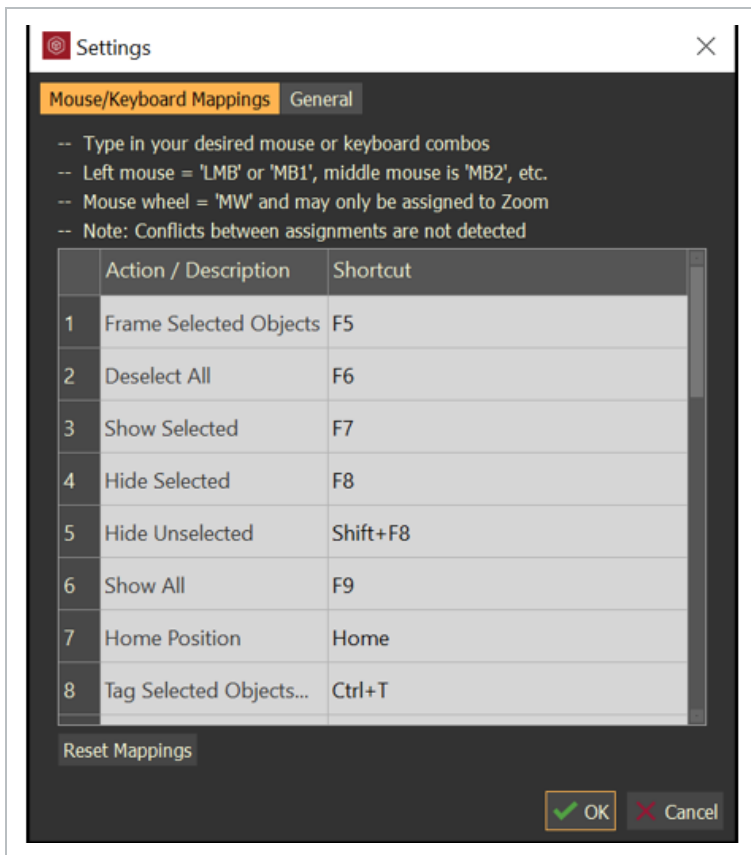

5.7.3 CHOOSE DEFAULT ZOOM BEHAVIOR

Allows for the user to set Zoom to Center or Zoom to Cursor.

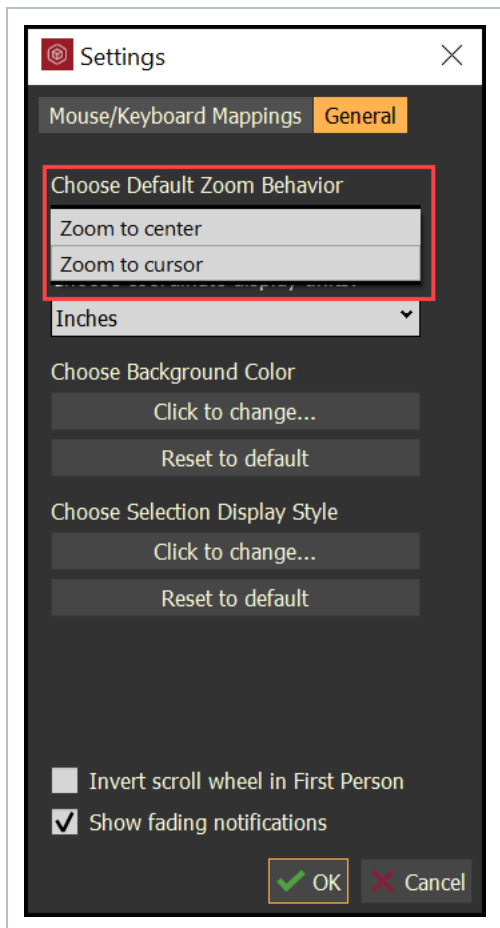

5.7.4 COORDINATE DISPLAY UNITS

Allows for the user to set the coordinate display units. This does not change the scale of the model.

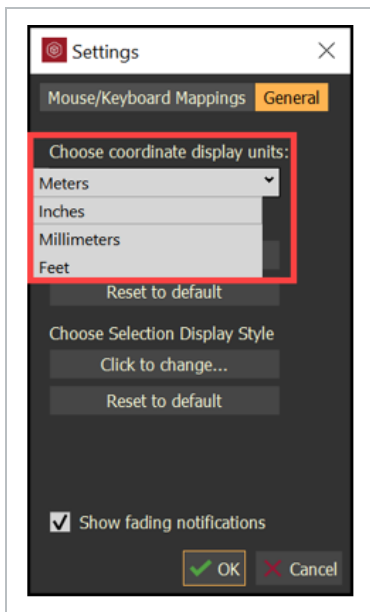

5.7.5 BACKGROUND COLOR

Allows for the user to change the background color of the 3D viewer.

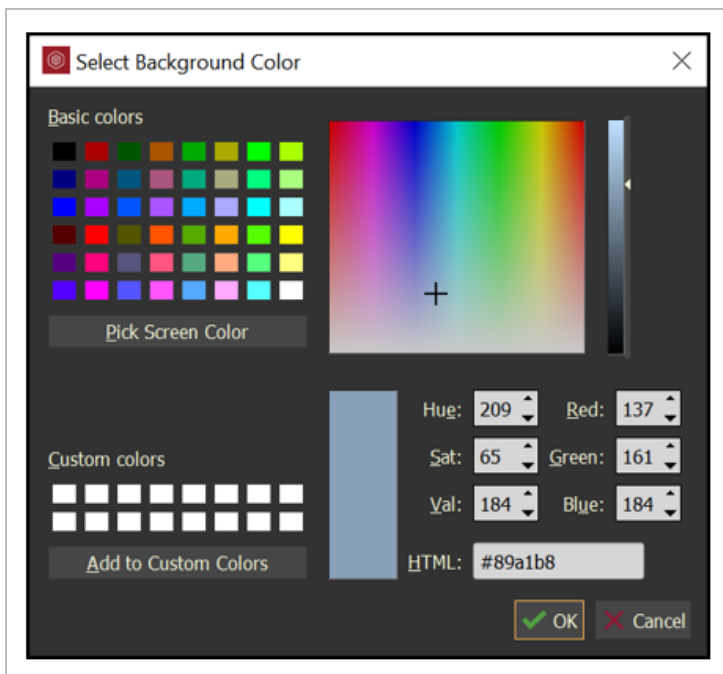

5.7.5.1 CHOOSE SELECTION DISPLAY STYLE

Allows for the user to manage display of selected objects. Manage the ability to show lines (edges) of the objects in a desired color and the ability to color selected objects with a fill color.

**NOTE**

Choose Fill Color... also has transparent settings.

5.7.6 INVERT SCROLL WHEEL IN FIRST PERSON

Allows for the user to manage the "head tilt" within the First Person.

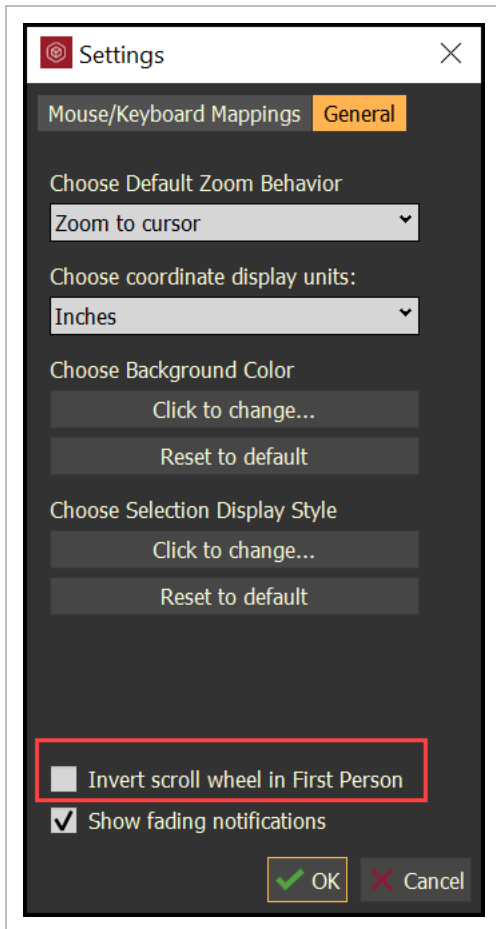

5.8 CREATE NEW MARKUP

A new markup can be created within the viewer and saved to a PDF file. Access it through **View -> Create New Markup**. Once Create New Markup is selected, a snapshot of the current 3D Viewer is captured and ready for a markup.

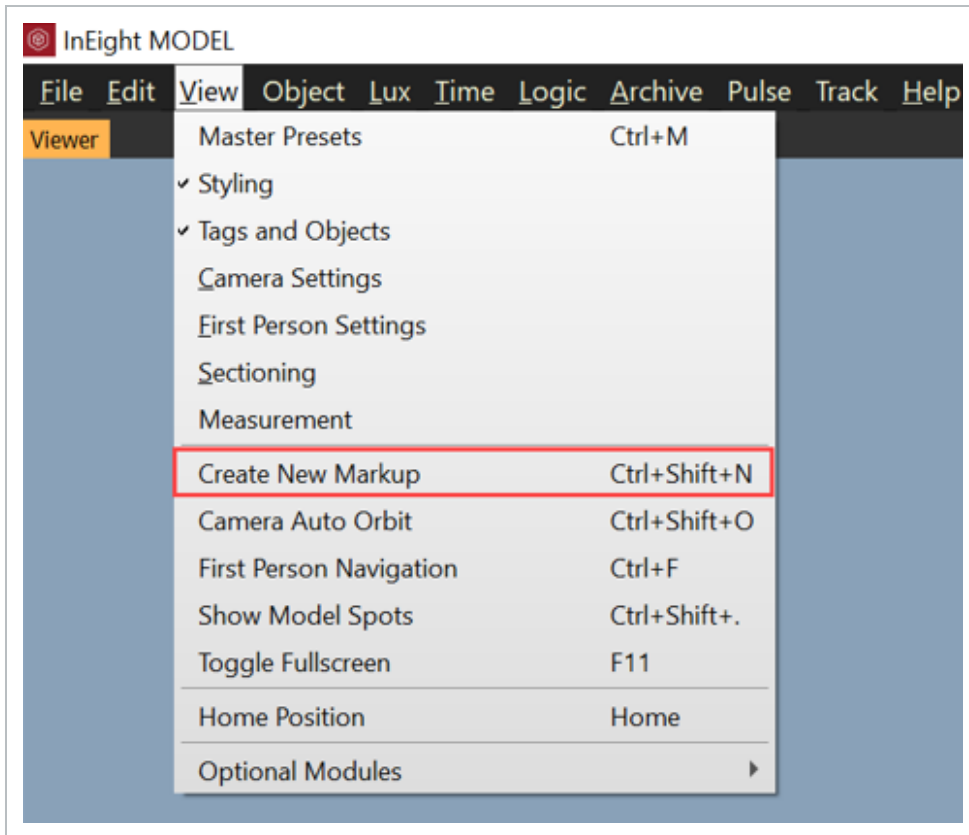

The markup capabilities allow the user to place Arrows, Scribble, Ellipse, Rectangles, and Text.

NOTE

The text size can be adjusted with the Thickness bar.

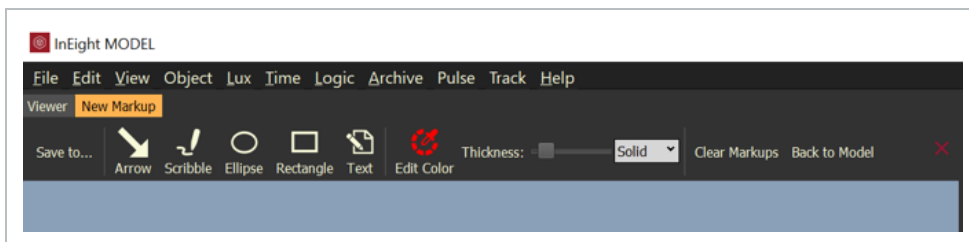

- Set the **Color**, **Thickness** and line type to a **Solid** or **Dashed** before placing an object
- Once objects are placed, they cannot be edited. They can, however, be deleted by selecting the object, then select the DEL key on the keyboard.
- Text color and size can be edited after placement. Select and highlight the text, then select edit color and/or move the thickness bar to change the text size.

Select **Save to...** to save the markup as a PDF file.

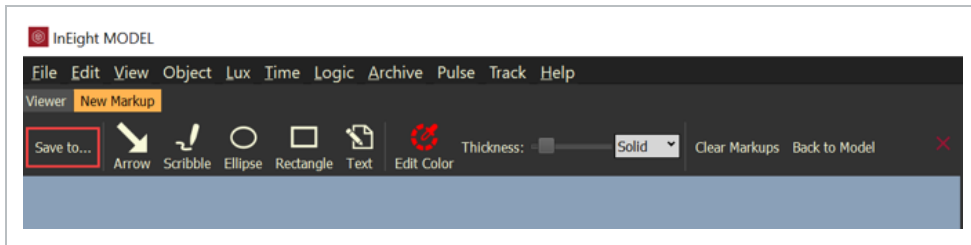

NOTE Once the new PDF file is saved, the existing markup is still active.

Select **Clear Markups** to clear all markups.

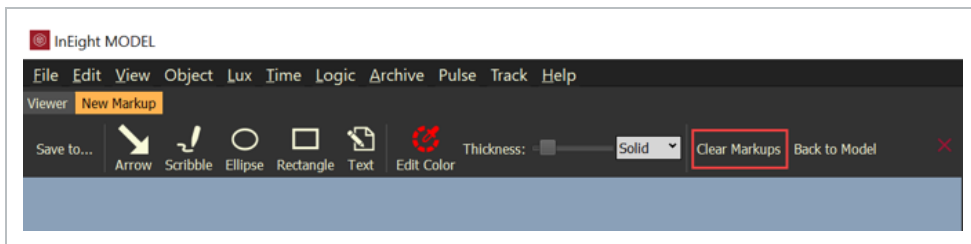

Select **Back to Model** to toggle from the New Markup to the 3D Viewer

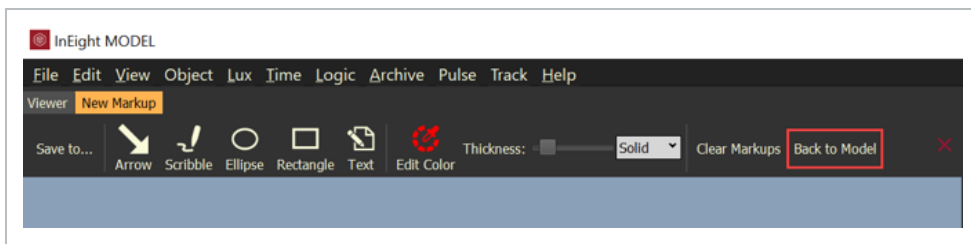

Select the **red X** to close the Markup tool.

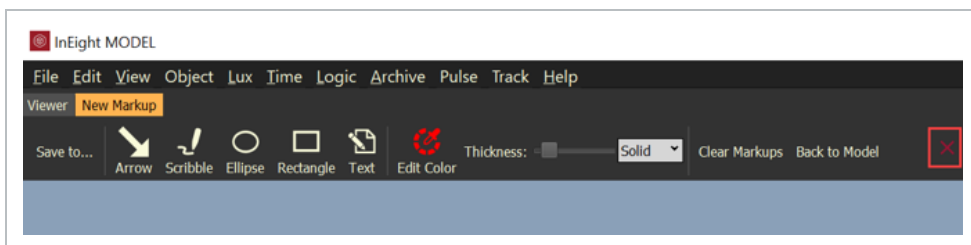

5.9 GRIDS

If grids are part of the Revit project, then they are included in the export process.

Grids can be toggled on and off through the main menu. Use the following step by step to toggle the grids on or off.

5.9 STEP BY STEP 1 – TOGGLE ON OR OFF GRIDS

1. From the main menu, click **View**.
2. Select **Show Grids**.

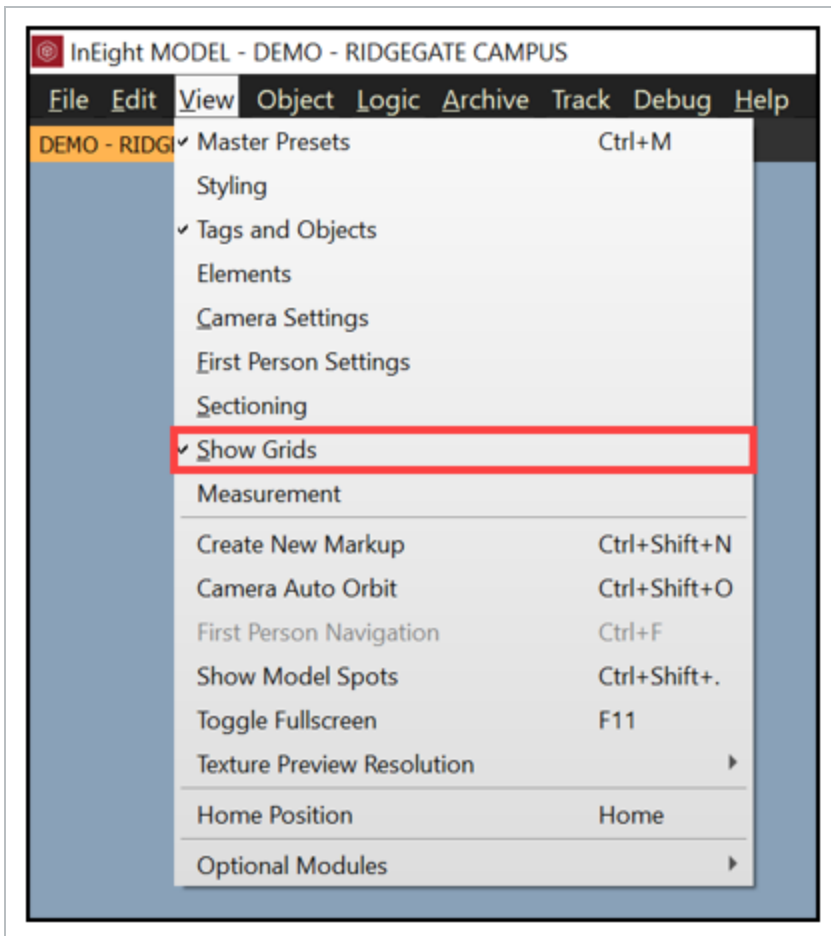

Grids can also be toggled on and off from the notification panel at the bottom left in the application.



LESSON 5 REVIEW

1. How can you navigate in InEight Model?
 - a. Using your mouse
 - b. Using the Navigation Widget
 - c. Using hot keys
 - d. All of the above

2. If you right click on your mouse, what two menus appear?
 - a. Trash, Model settings
 - b. Plugin History, Show/Hide
 - c. Show/Hide, Selection
 - d. Selection, Trash

3. You can navigate a model from a First Person View.
 - a. True
 - b. False

LESSON 5 SUMMARY

As a result of this lesson, you can:

- Navigate InEight Model
- Select model objects
- Use common hot keys

This page intentionally left blank.

CHAPTER 6 – PROJECT UPDATES AND HISTORY

6.1 COMMAND HISTORY

As content is added to the model environment, a complete history is tracked, saved, and accessible anytime through the lifetime of the project. The Command History panel provides the insight as to what actions have been taken before they have been saved to the project.

The Command History panel is located from the main menu, Edit -> Command History or with the Ctrl+H hotkey.

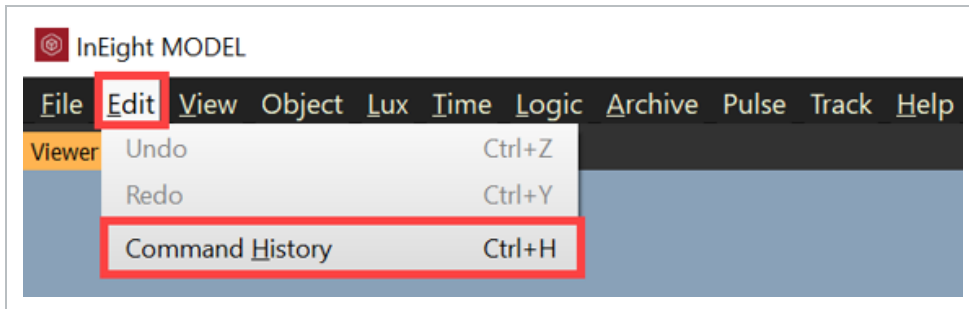

As changes are created within the model environment, they are listed in the Command History until the user saves the changes to the project. Also, there will be an * following the project name to indicate that there are changes.



You can undo any changes by selecting a previous change or selecting <empty>. Notice that the project name no longer has an * following the name.



To reactivate the changes, simply select on the last change that you want applied to the project. Then Save the changes to the project with Ctrl+S or select File -> Save Project...

The Save Changes dialog box will open with a description of the project changes.

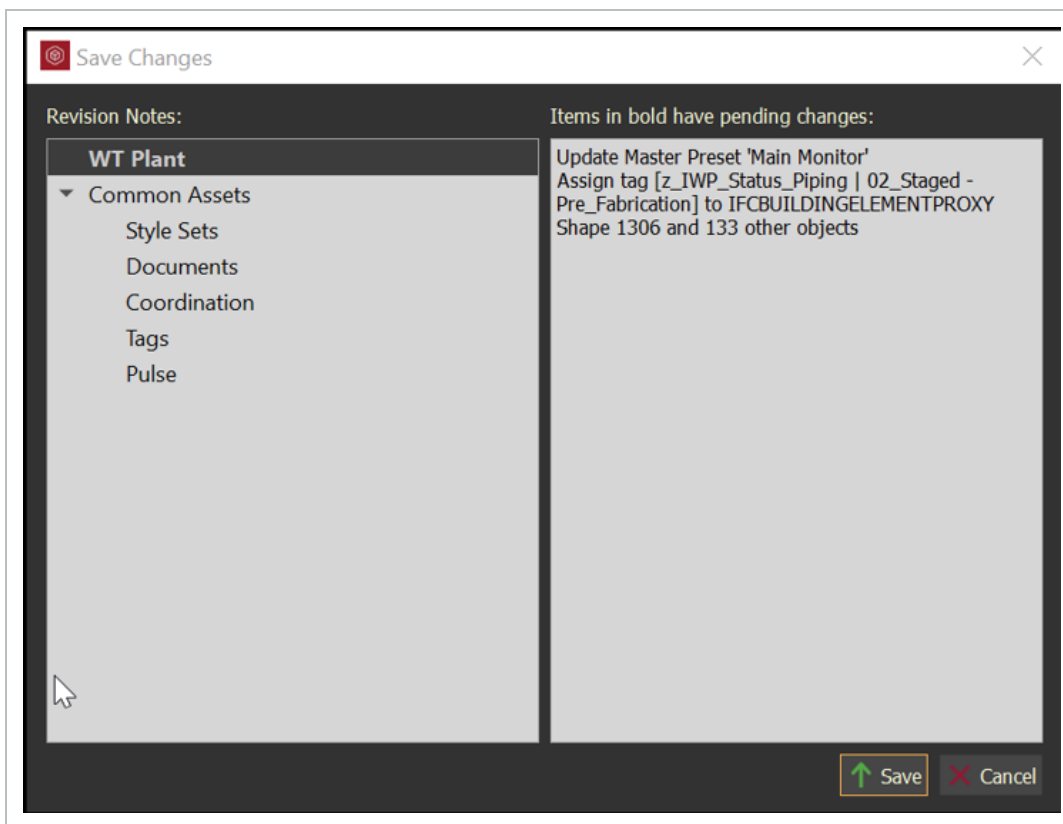

6.2 PROJECT UPDATES

When a user has saved updates to the project each user currently within the project will get a notice: **You have project updates.**

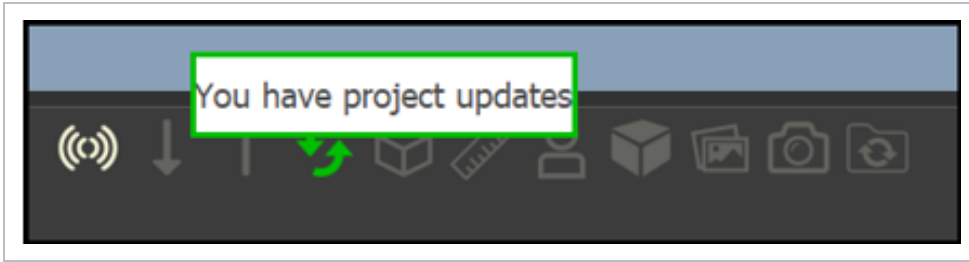

Right click on the green sync icon and select Update Now to retrieve the latest project updates.

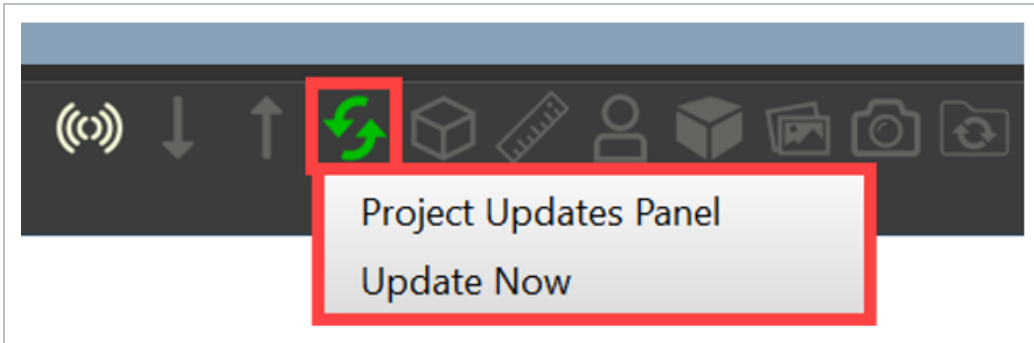

Or select Project Updates Panel to review the Update Details and by who. Once reviewed, then click Update Now to update your current session with the latest project updates.

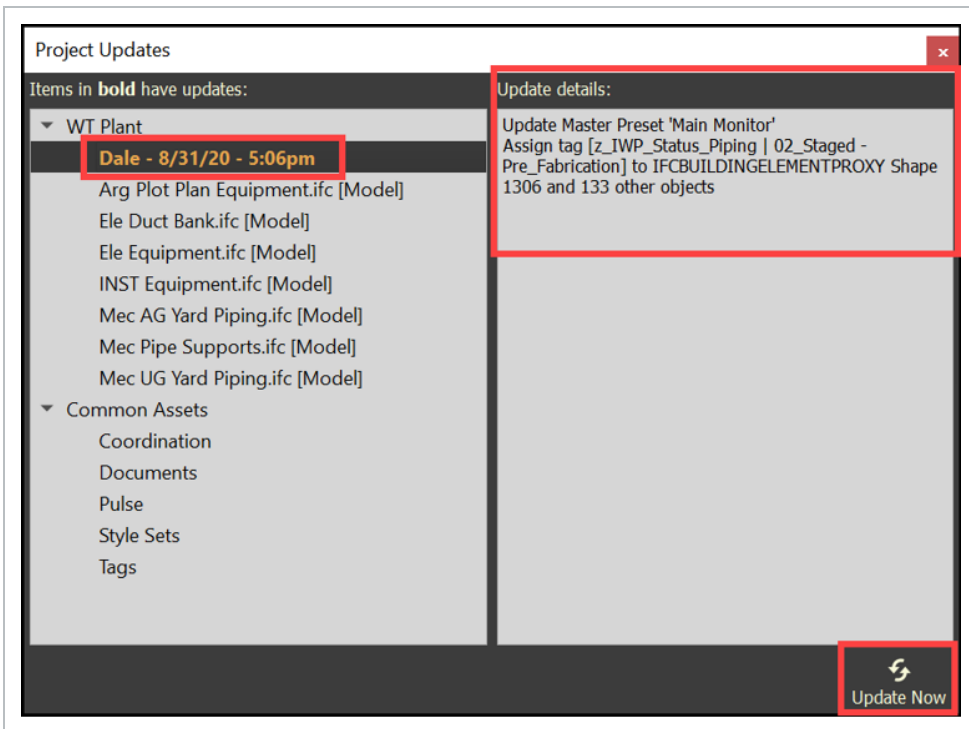

If there are and a user tries to save their project changes, then a Project Not Current dialog box will appear, requiring the user to perform a project update before a project save can take place.

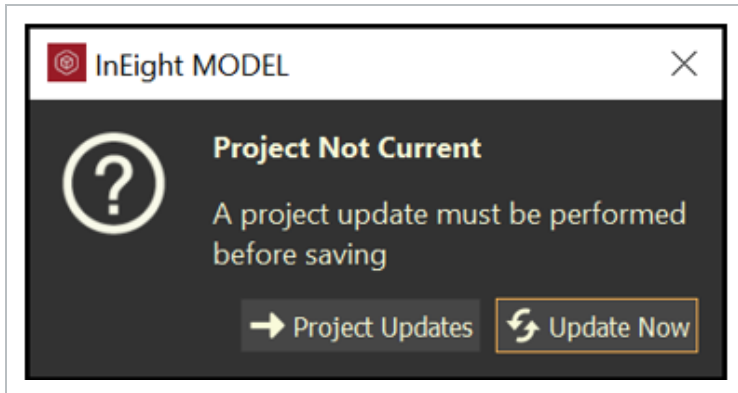

6.3 PROJECT HISTORY

Project History allows users to view a project at any stage, from the beginning all the way to the end of a project.

The Project History panel is located from the main menu, File -> Project History or with the Ctrl+Shift+H hotkey.

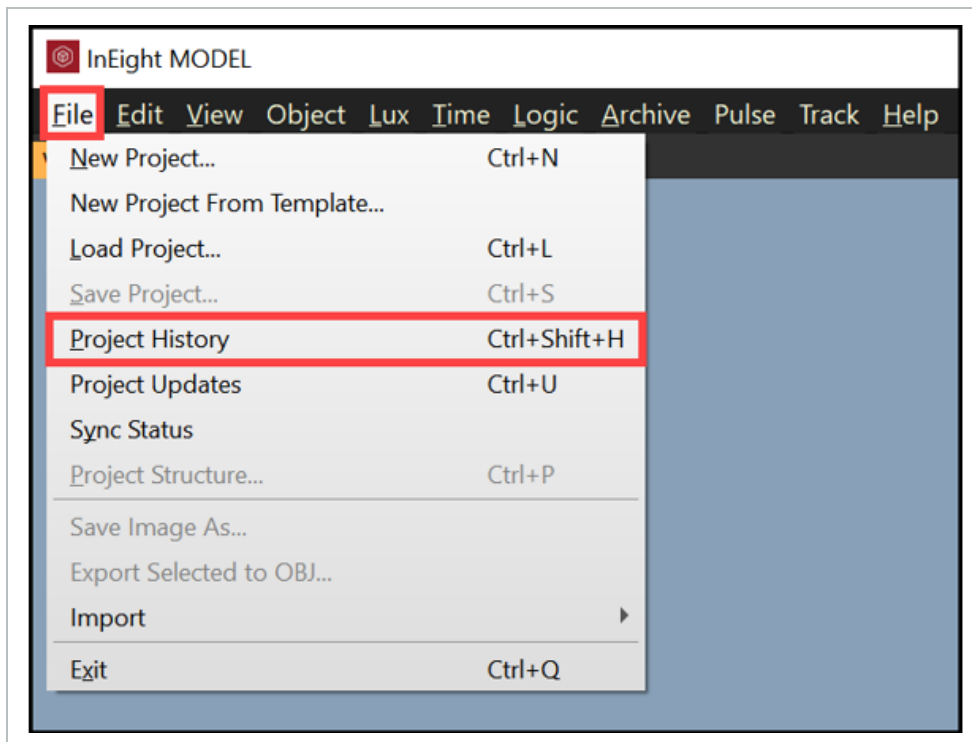

The Project History panel provides the ability to look at the project in a historical view. This can be achieved by:

- Jump to date and then click Go
- Project Revisions - search revisions made by a particular user or search for keywords from the Revision Notes history.

- Revision Date - double click on a revision date

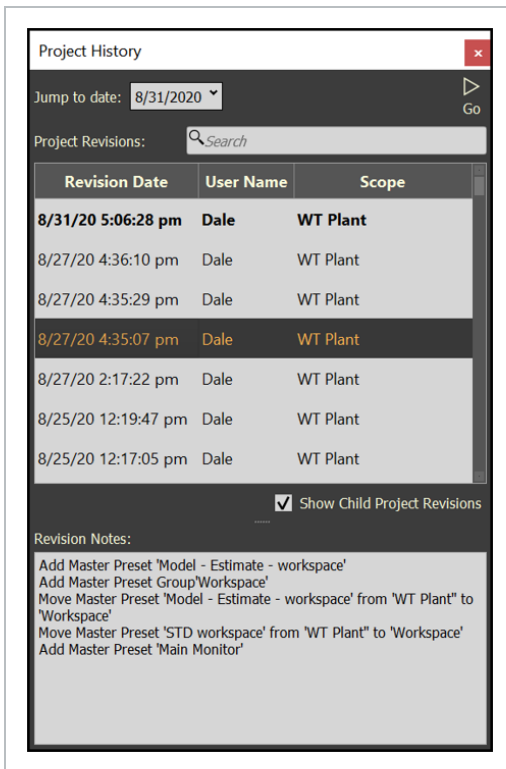

When an older revision is activated, a red box will appear around the 3D Viewer and the project will be rolled back to that particular time in the project’s history.

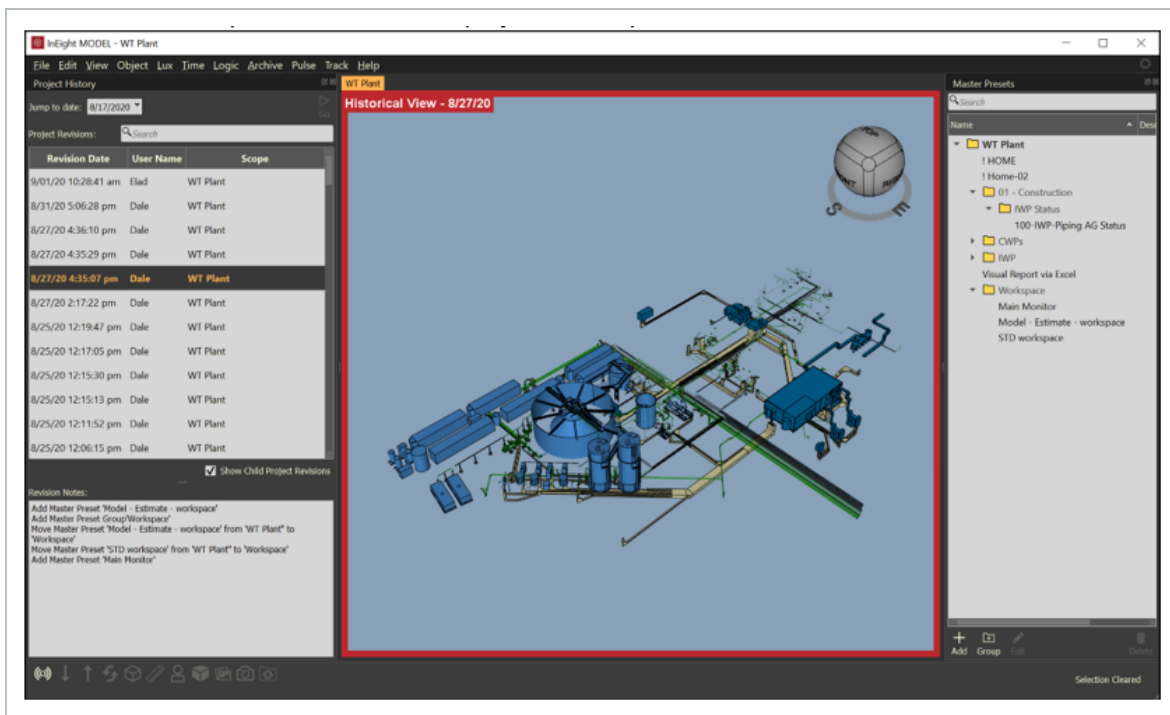

NOTE

In order to get back to the current version of the project, double-click on the first date listed at the top of the Revision Date list. Once the model is back to the current version, the red box will disappear.

LESSON 6 REVIEW

1. Once you've made a change in model, the previous state can never be recovered.
 - a. True
 - b. False

2. Users cannot save changes to their project if a project update is available.
 - a. True
 - b. False

LESSON 6 SUMMARY

As a result of this lesson, you can:

- Access and review your model's history
- Understand how to update your project from the Project Update window
- Access the history of the commands taken on your project prior to saving Access and review

This page intentionally left blank.

CHAPTER 7 – TAGS AND OBJECTS

7.1 TAGS AND OBJECTS OVERVIEW

Tags are the organizational structure of model objects and define a set of identifiers (category and value). When you export a model through Revit or AutoCAD, or import an IFC file, you are creating tags and objects metadata.

Interact with tags to manipulate your model in a variety of ways, including:

- Selecting a group of model objects
- Visualizing your model with styles associated to tags
- Creating custom tags to enhance a model's value
- Linking documents and photos to tags
- Creating coordination rules to detect clashes

7.1.1 TAGS AND OBJECTS PANEL

To access your project's tags and objects, select **View** from the menu bar at the top of the screen. Then, select **Tags and Objects**.

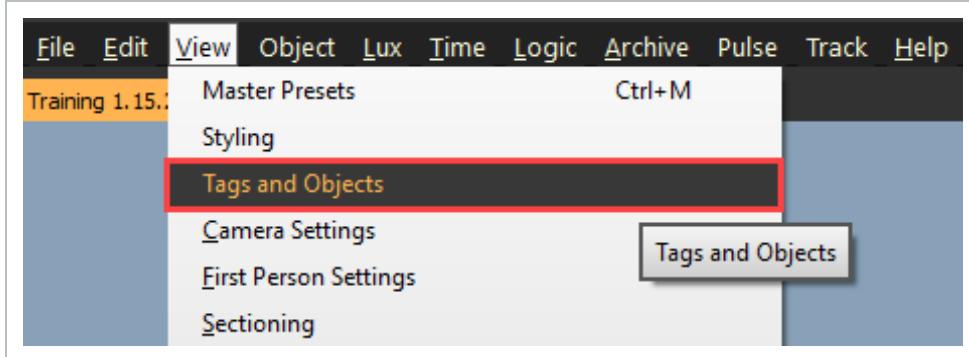

- This will launch the Tags and Objects panel

7.1.1.1 OBJECTS TAB

The **Objects tab** within the Tags and Objects panel displays all the model streams that are available within your project.

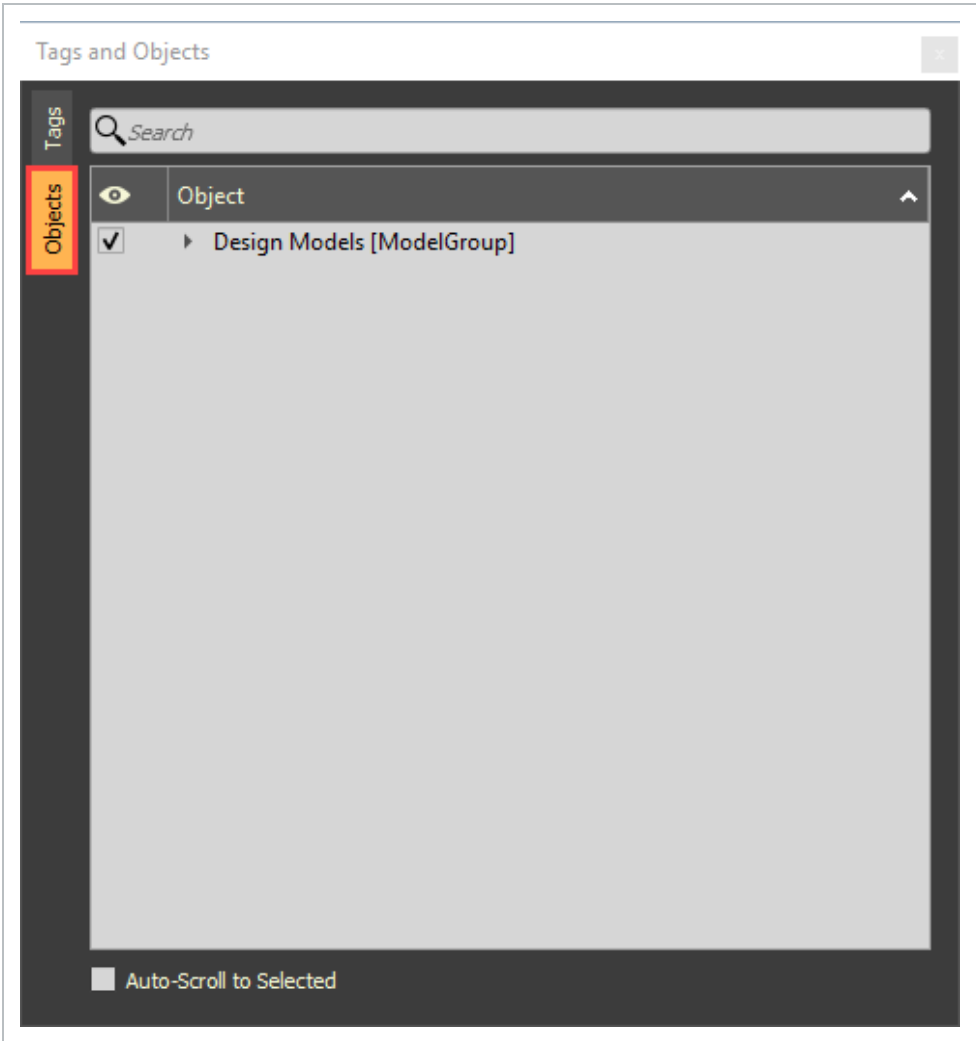

Search for objects in the search bar or use auto-scroll to expand the list of tags that relate to your selected model object(s).

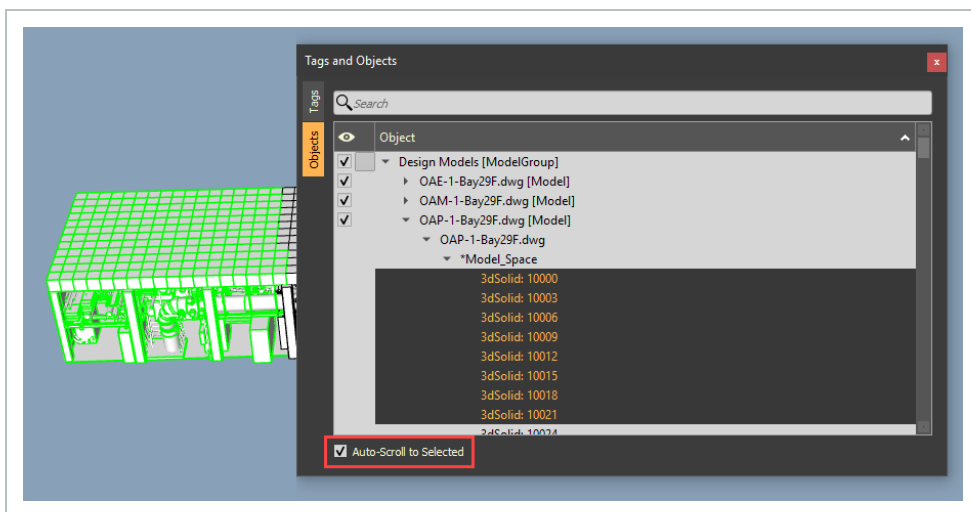
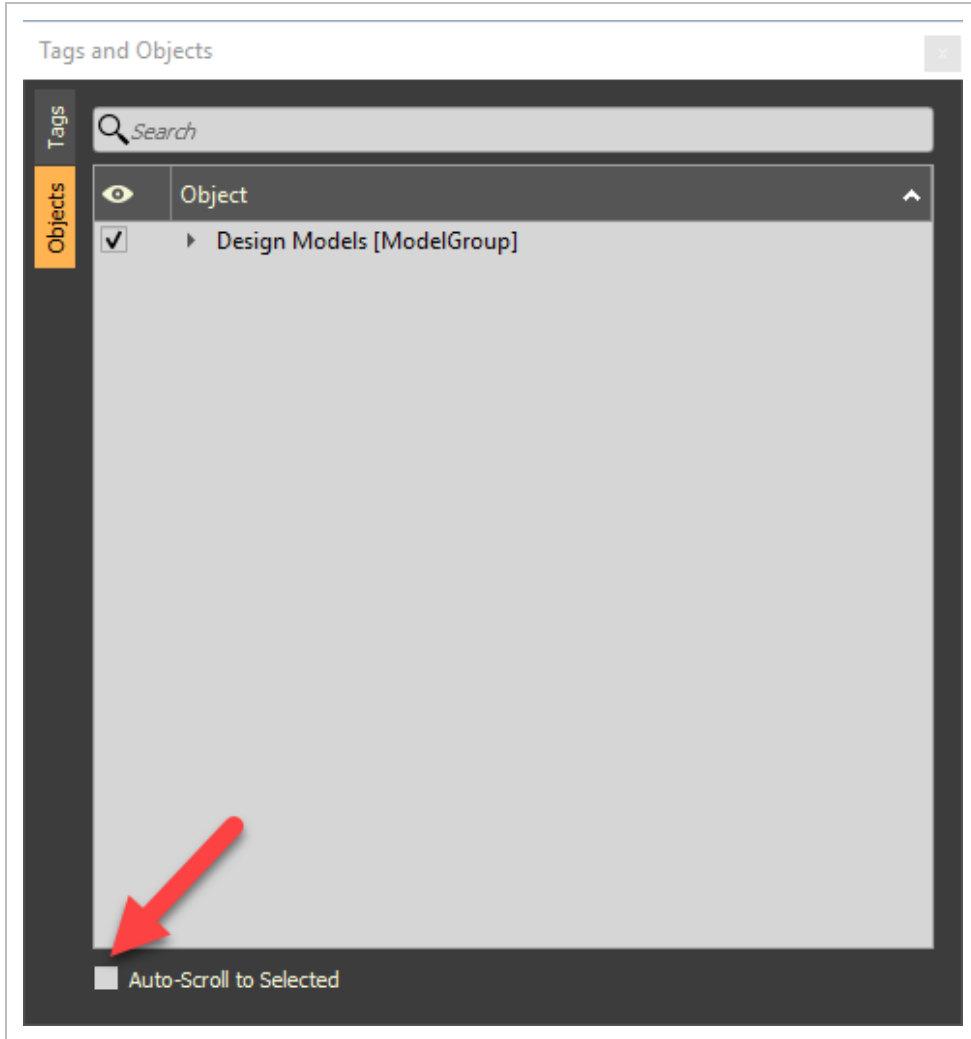

7.1 STEP BY STEP 1 – TOGGLE MODEL STREAMS VISIBILITY

1. From the Tags and Objects panel, select the **Objects tab**.
2. Toggle the **View check box** to turn the visibility of Model Streams on or off.



7.1.1.2 TAGS TAB

The **Tags tab** displays all the tags imported with the model streams and any dynamic or custom tags created.

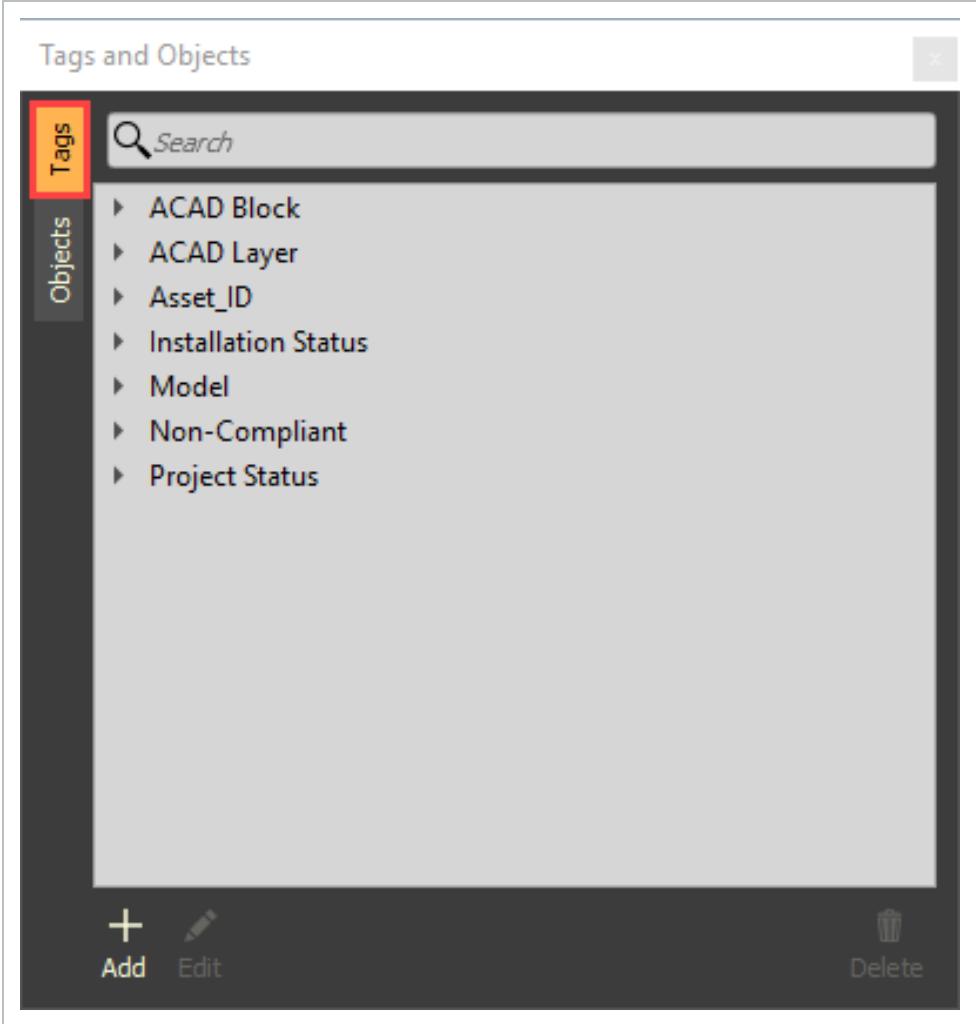

Select a tag category to expand its list of tag values or use the search bar to find a tag.

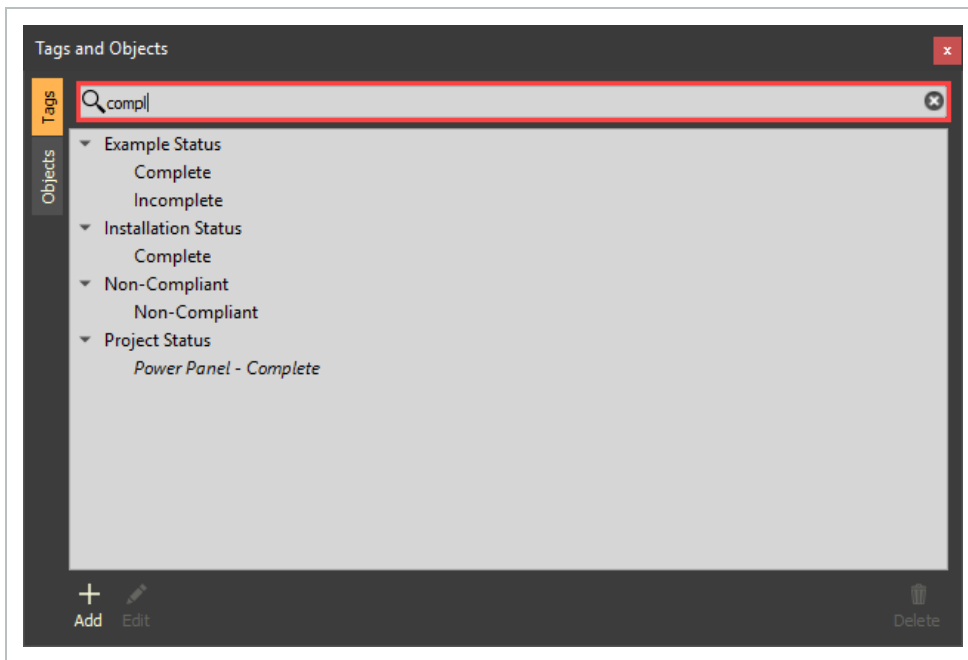

7.2 CREATE AND EDIT TAGS

Tags are fixed, or static, values within a defined category that help describe the objects to which they are assigned. You can only associate a model object to one **Tag Value** within a **Tag Category**. Create tags through the Model Exporter/Importer, manually in InEight Model or import tags from Excel. Use tags to help define and view your model through different lenses.

7.2.1 MANUALLY CREATE AND EDIT CUSTOM TAGS

Use custom tags to transform design models into construction models or owner models.

Add custom tags to:

- Normalize data to your specific nomenclature
- Unique Identifications
- Status
- Endless possibilities...

7.2 STEP BY STEP 1 – CREATING TAGS

1. From the Tags and Objects panel, select the **Tags** tab.
2. Next, select the **Add** icon.

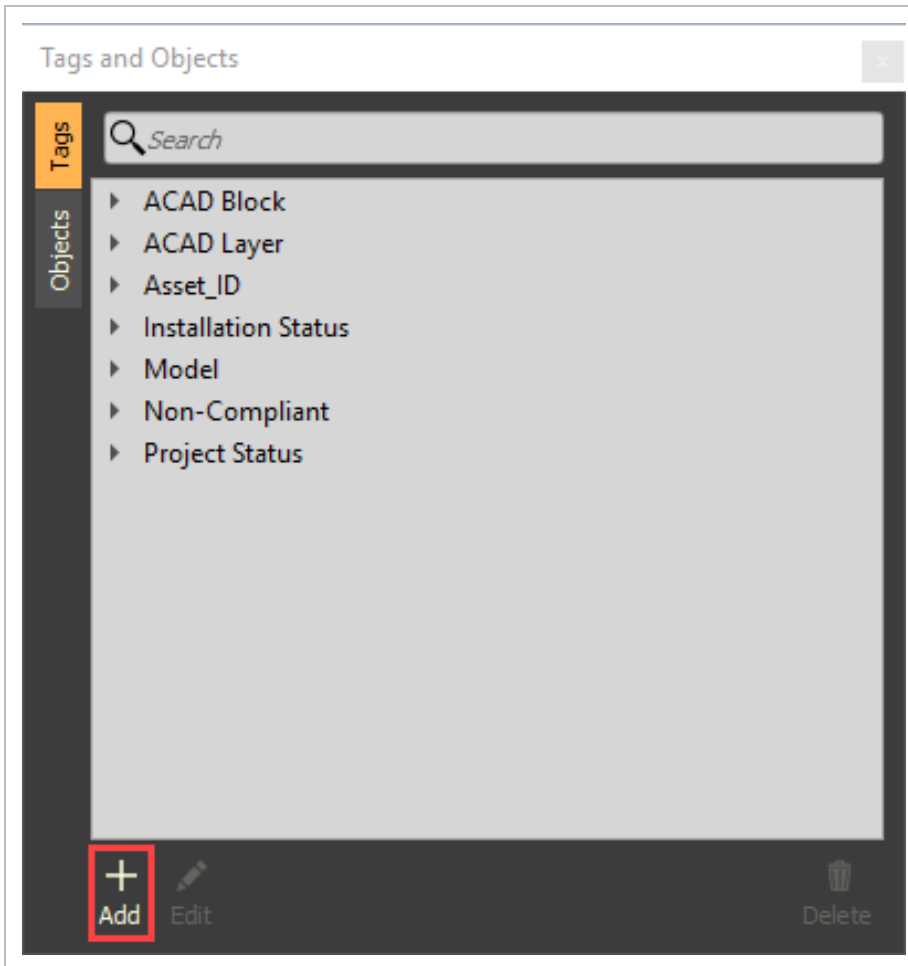
**TIP**

If there are model objects selected, **Ctrl+T** will open the Tag dialog box.

3. The Tag dialog box will open. Enter a tag category name and select **Add New**.

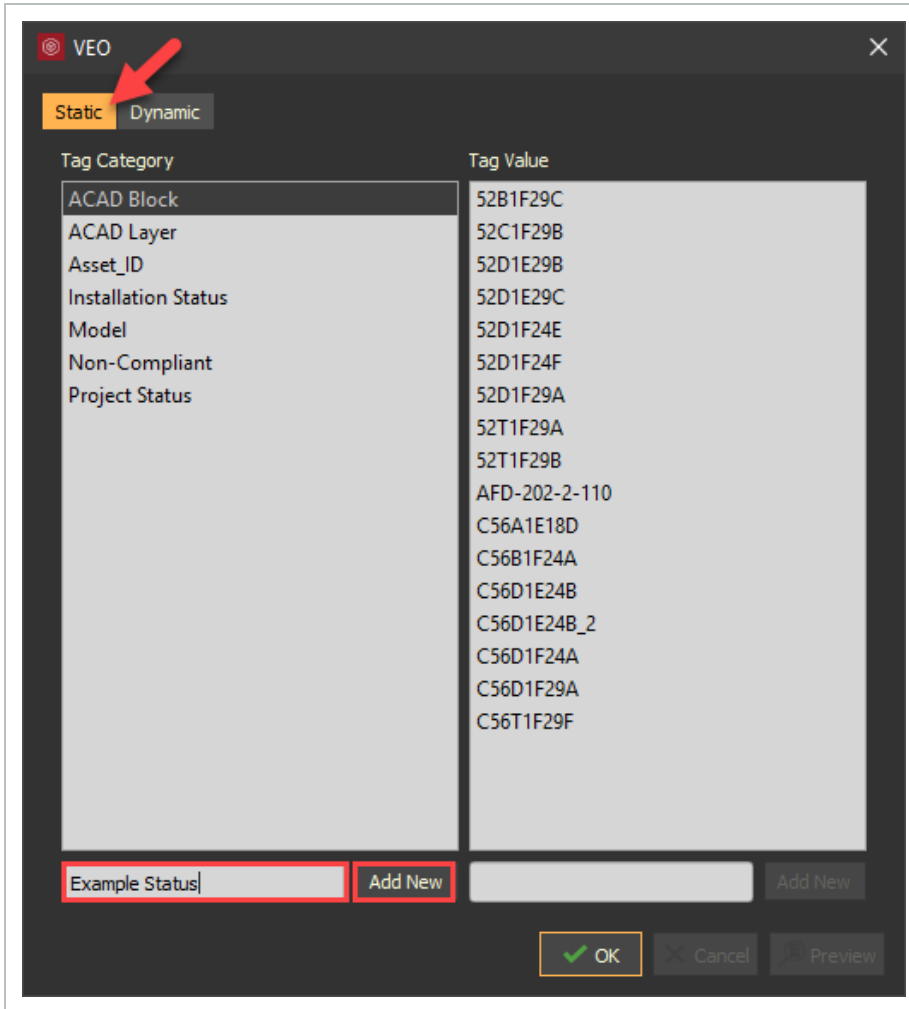

- Once you select Add New, the new Tag Category is created and selected

NOTE If you select **OK** without first selecting **Add New**, you will close the Tag dialog box without saving your tag category name.

4. Enter a tag value and select **Add New**.

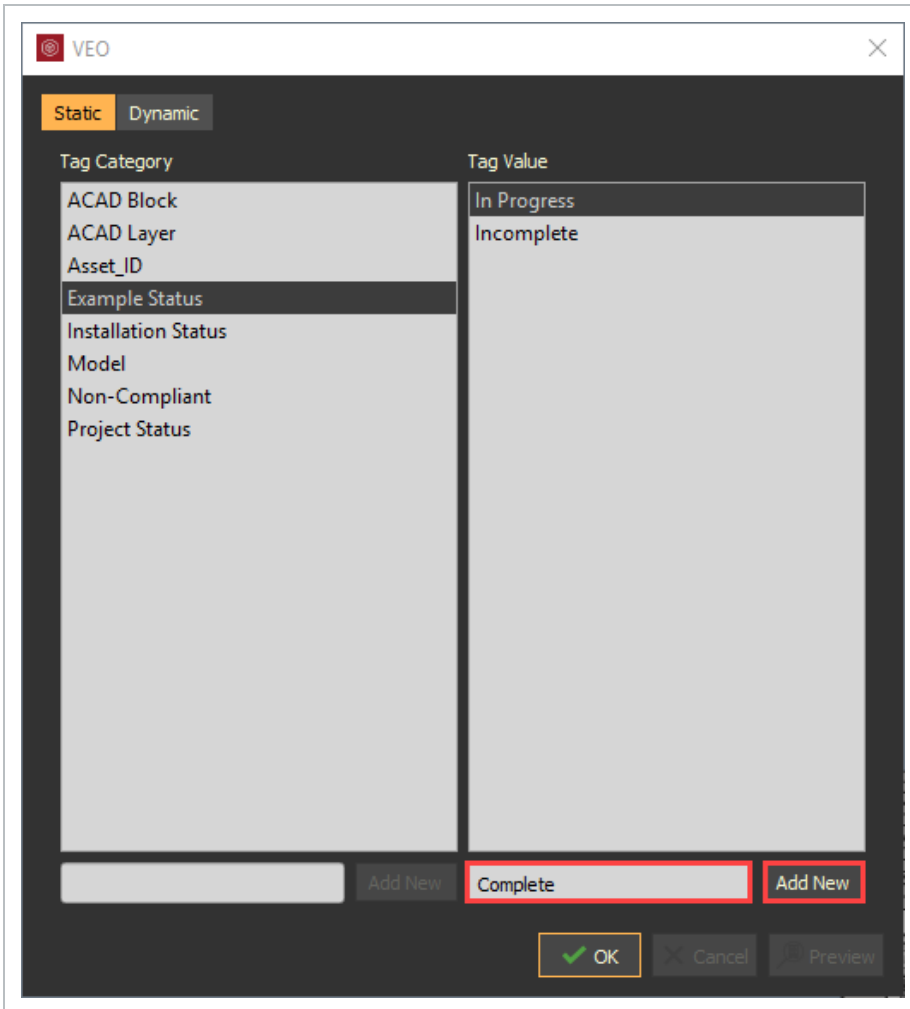

5. Now, select **OK** to save your new tag(s).

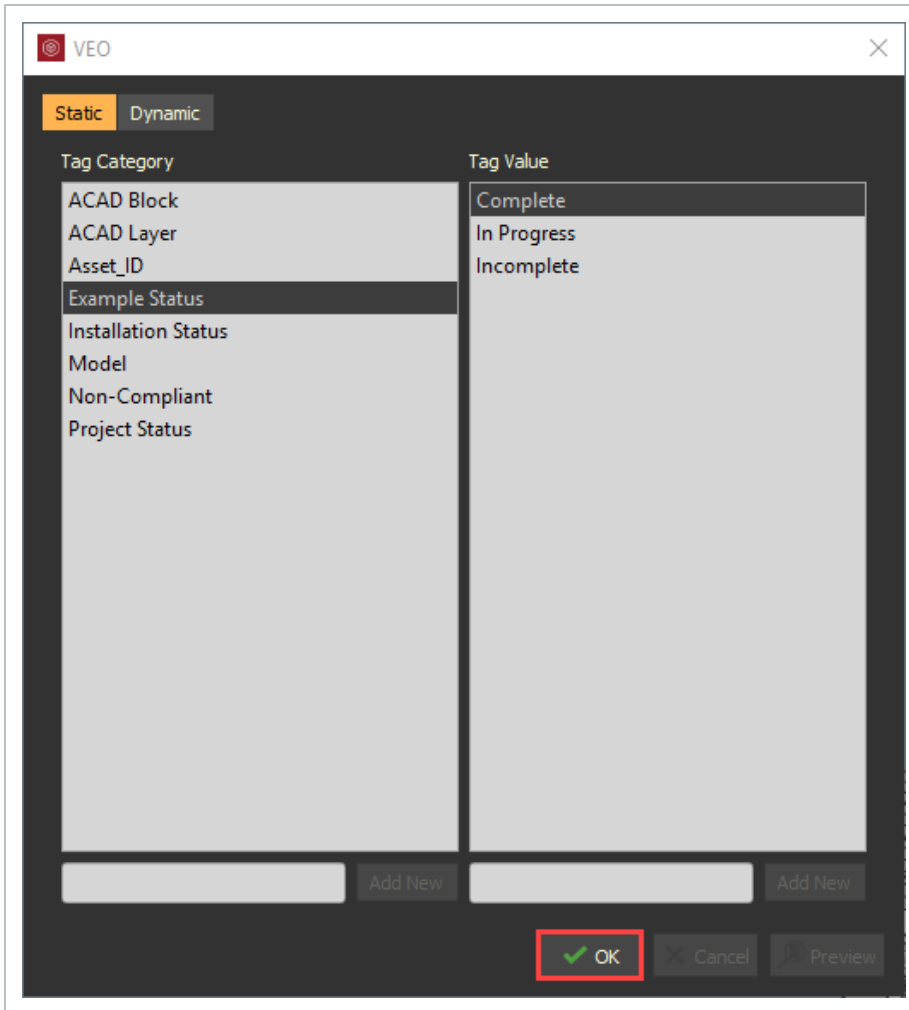

NOTE If any model objects are actively selected, a note will appear in the Tag dialog box asking you to confirm that you want to apply your tag to those selected objects.

6. Your new tag will appear in the Tag panel.

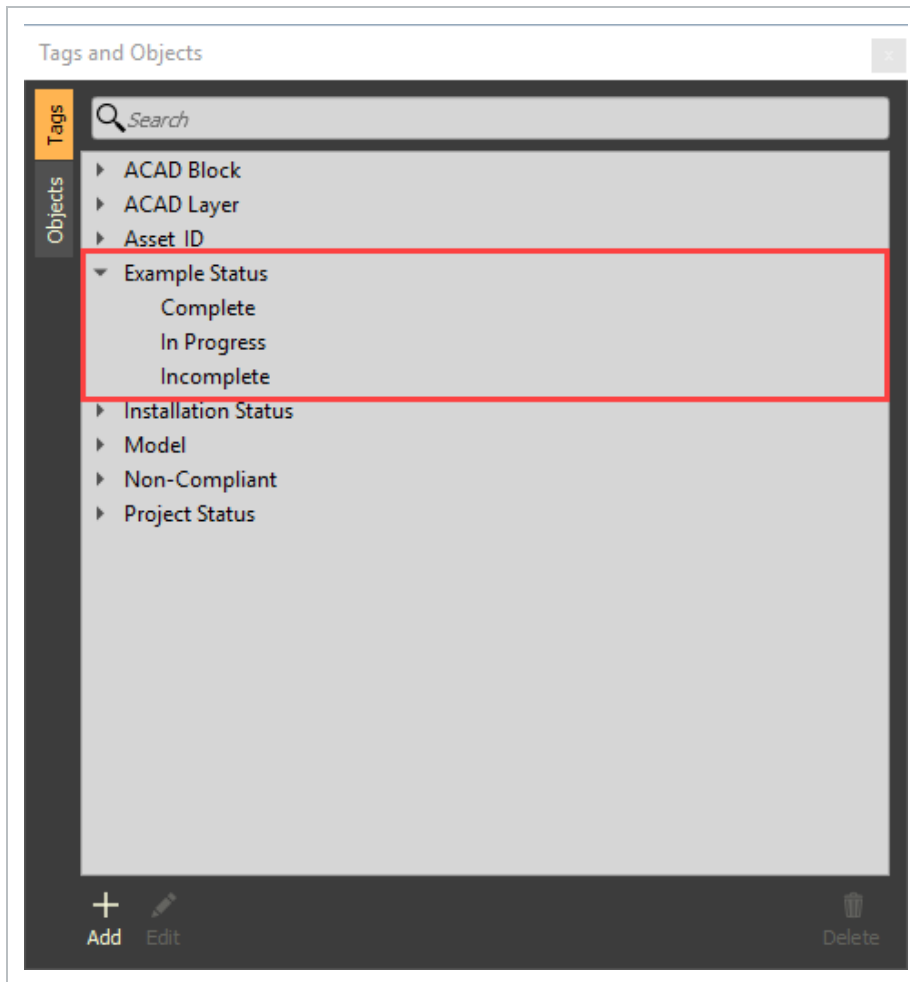

7.2.2 DELETE A TAG

Any tags from the Model Exporter / Importer process deleted are not really deleted. They are still in the database but hidden from the Tag panel. The next Model Exporter / Importer process will not import any tag that has been deleted.

7.2 STEP BY STEP 2 – DELETING TAGS

1. From the Tags and Objects panel, select the **Tags** tab.
2. Select the tag category or tag value(s) you want to delete, then click on the **Delete** icon.

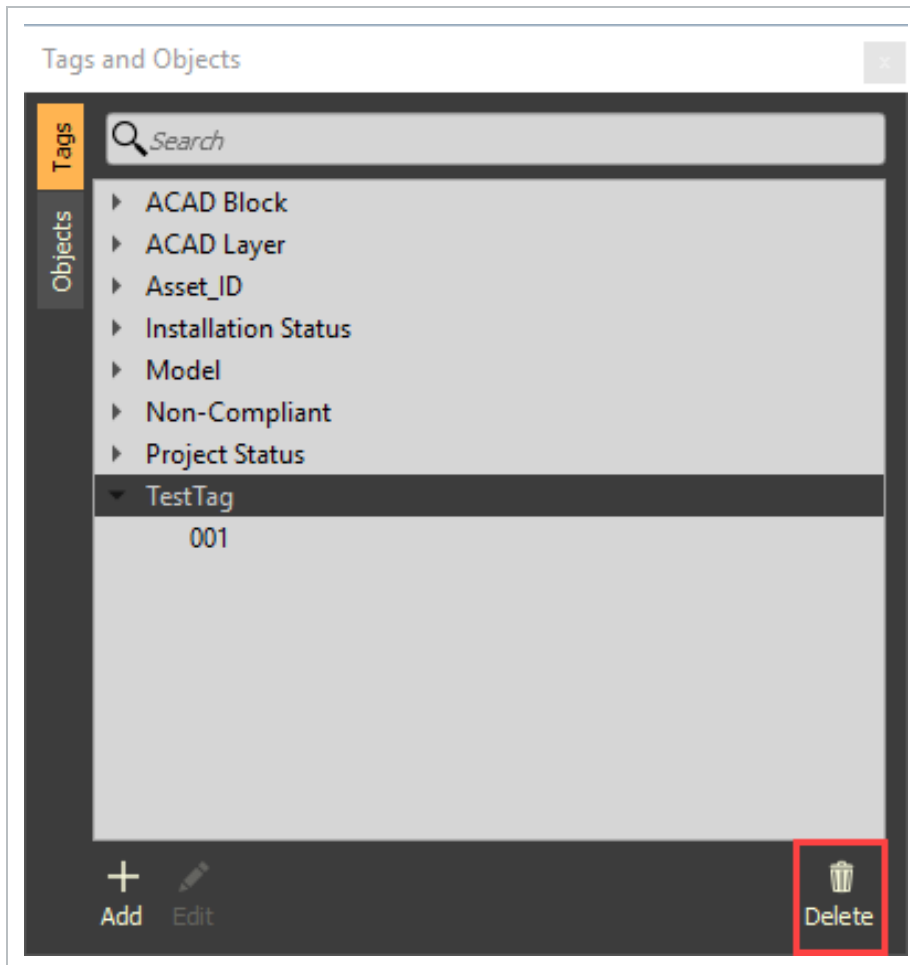

7.3 CREATE AND EDIT DYNAMIC TAGS

Unlike static tags, dynamic tags are controlled by rule sets. They are powerful tools in creating custom groups of objects for various interactions. Use Dynamic tags to configure coordination rules and normalize data.

7.3 STEP BY STEP 1 – CREATING DYNAMIC TAGS

1. Open the **Tags and Objects** panel.
2. Check that no model objects are actively selected.
3. Select the **Add** icon to open the Tags dialog box.
4. Select the **Dynamic** tab.

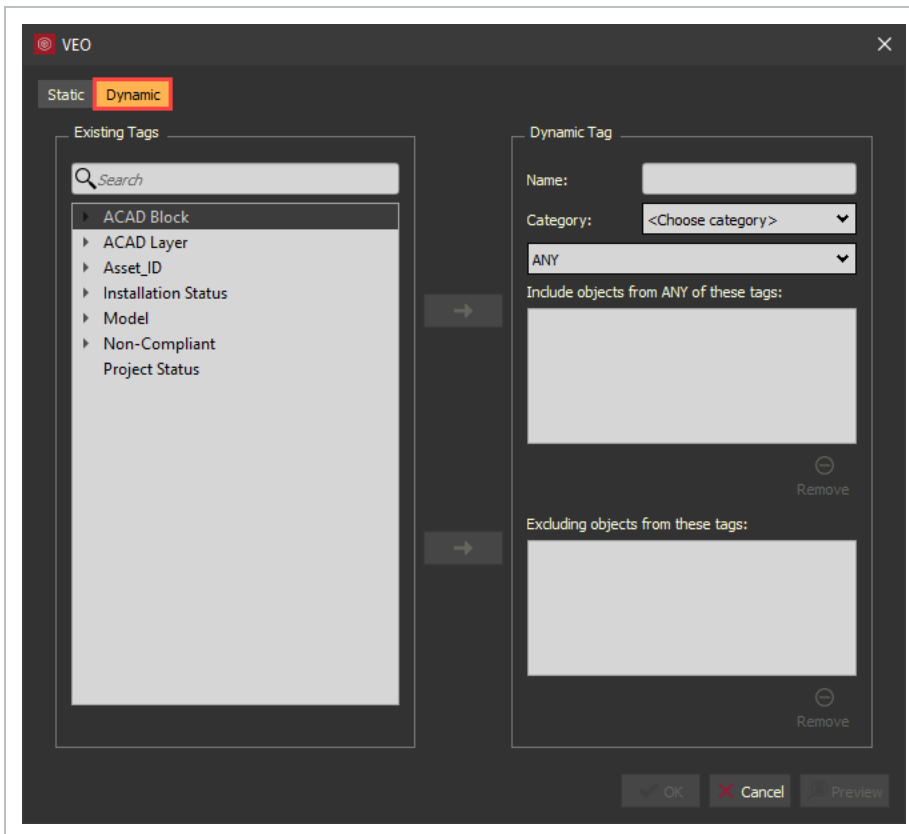

5. Enter a name and select a category from the drop-down menu or select **New**....

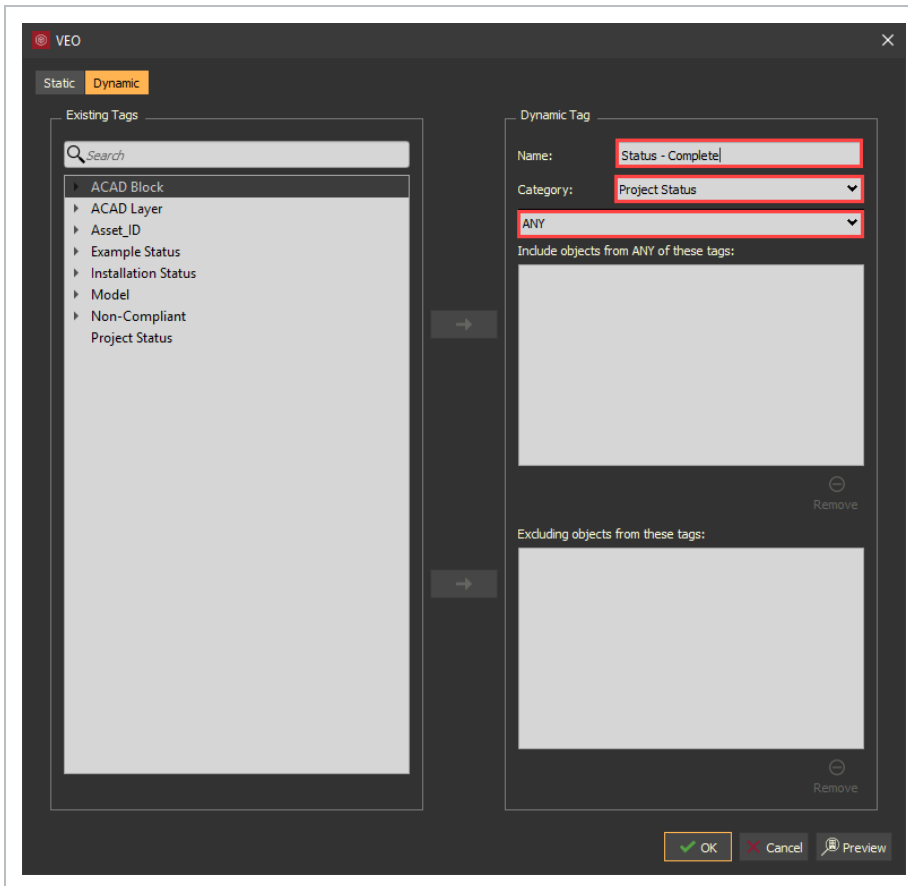

6. Select either **ANY** or **ALL** from the drop-down menu.

TIP

ANY includes any object from ANY of the tags selected.
ALL includes objects that have ALL of the tags selected.

7. From the existing tags list on the left, select the tag(s) you want to include.
 - Use the top arrow to direct that tag from the existing options to your dynamic tag inclusion list on the right. Repeat until you have moved all desirable tags to the included list on the right

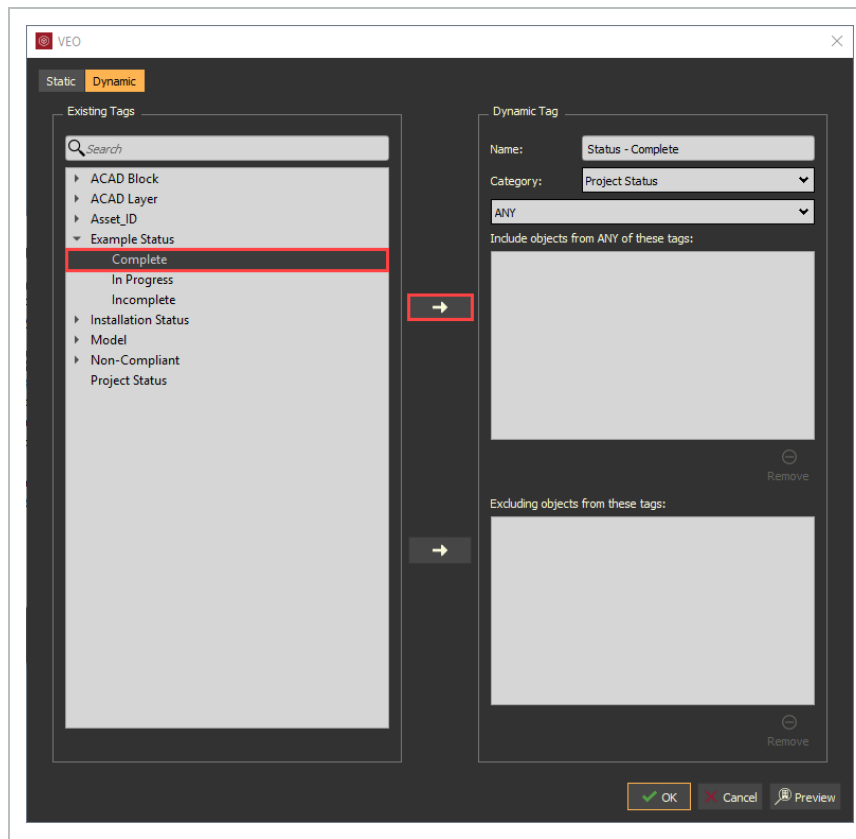

NOTE Existing Tags can be multi-selected by holding CTRL or SHIFT keys on the keyboard.

8. From the existing tags list on the left, select the tag(s) you want to exclude.
 - Use the bottom arrow to direct that tag from the existing options to your dynamic tag exclusion list on the right. Repeat until you have moved all undesirable tags to the

excluded list on the right

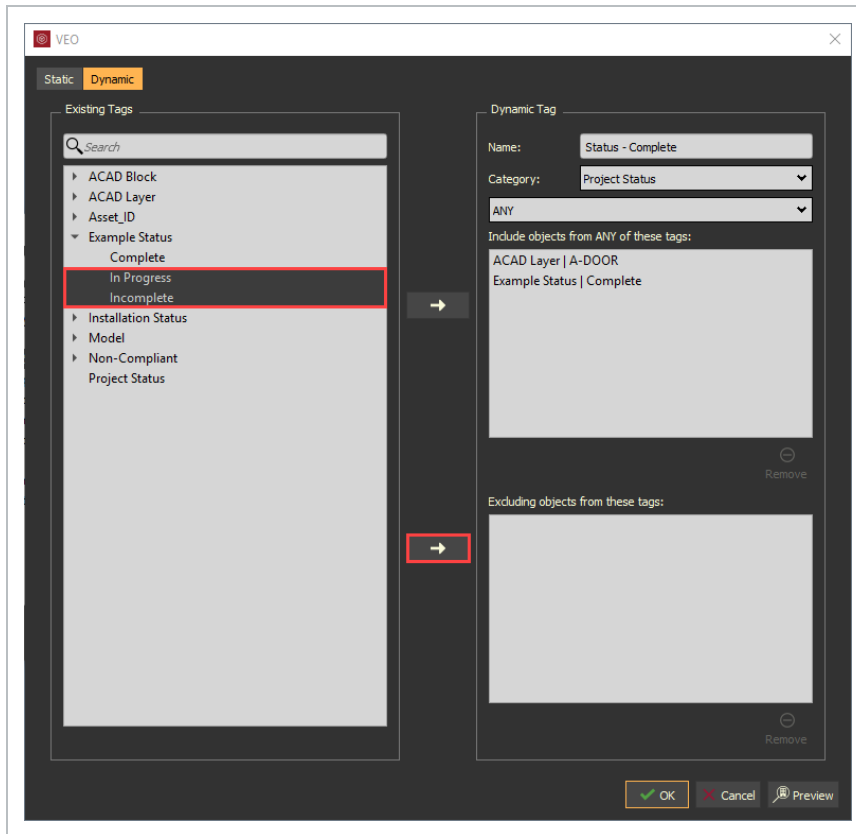

NOTE The same tag cannot exist in both the included and excluded fields.

9. Preview the results of your dynamic tag by selecting the **Preview** icon.
 - This will select all model objects that meet the Dynamic Tag criteria

10. To save this dynamic tag, select **OK**.

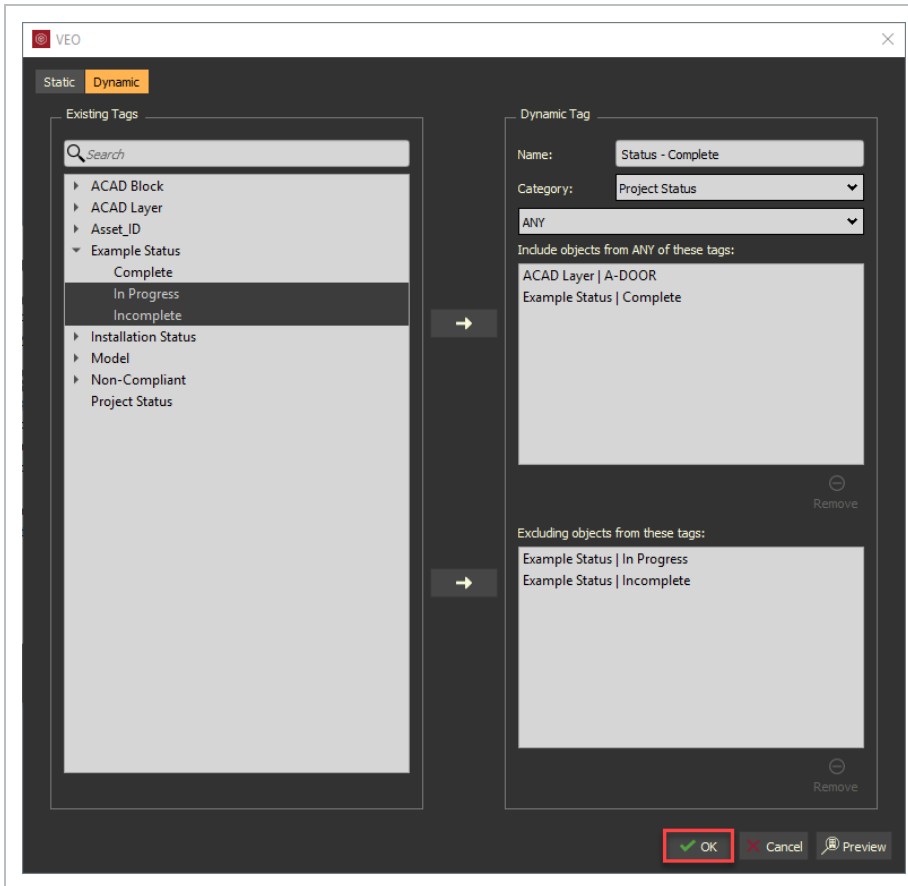

NOTE

Dynamic tags will not appear in the Existing Tags Column, and therefore cannot be used in another dynamic tag.

Within the Tags and Objects panel, under the Tags tab, Dynamic tags appear in italics.

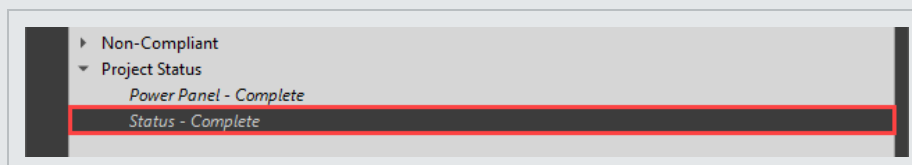

7.3 STEP BY STEP 2 – EDITING A DYNAMIC TAG

1. Open the **Tags and Objects** panel.
2. Select the dynamic tag you want to edit. Select the **Edit** icon or right click and select **Edit Dynamic Tag** from the drop-down menu.

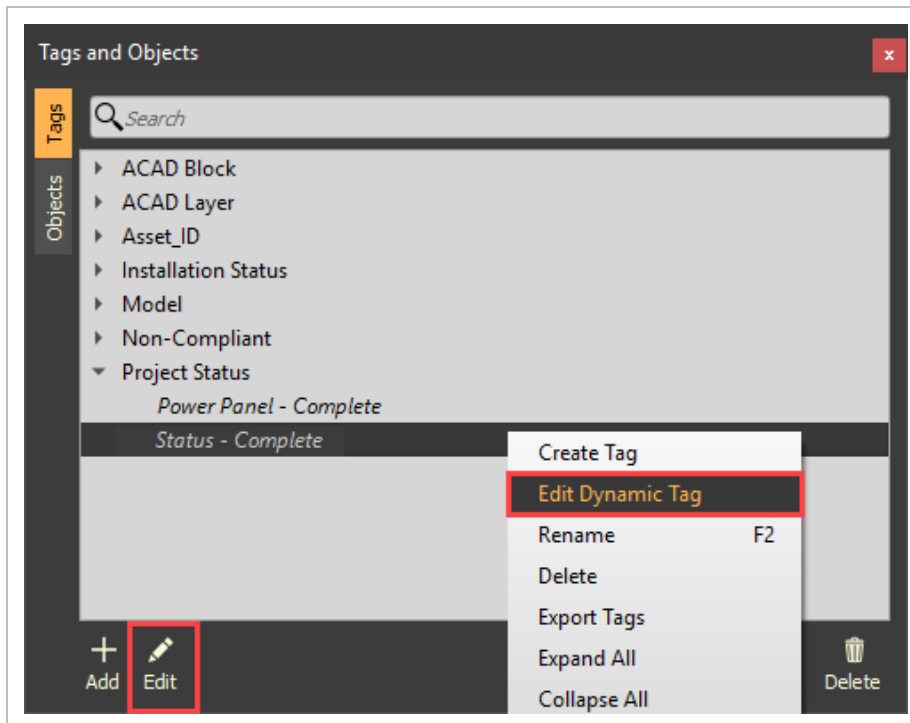

7.4 ASSIGN AND REMOVE TAGS

7.4.1 ASSIGNING TAGS

Assign custom created tags to model objects to enrich the model with actionable metadata.

7.4 STEP BY STEP 1 – ASSIGNING TAGS

1. Select desired model objects.
2. Use the Tags hot key **Ctrl + T**, or right click to view the **Selection Menu**.

3. From the Selection Menu, click on **Tag Selected Objects**.

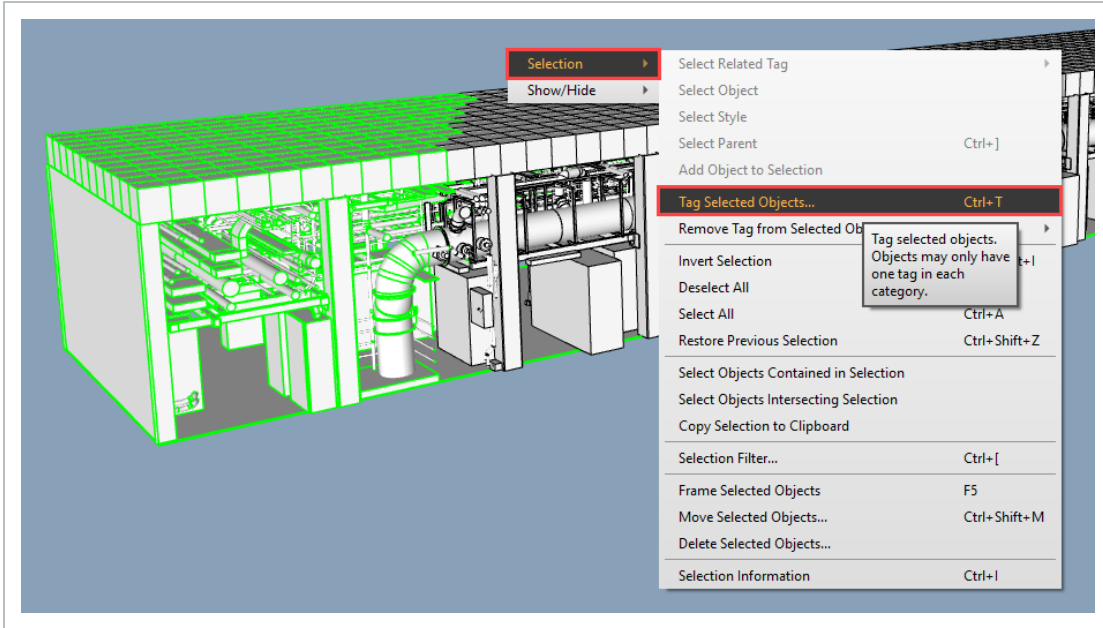

4. From the Tags dialog box, select a tag category and value(s) you wish to apply to your selection.

5. Click **OK**.

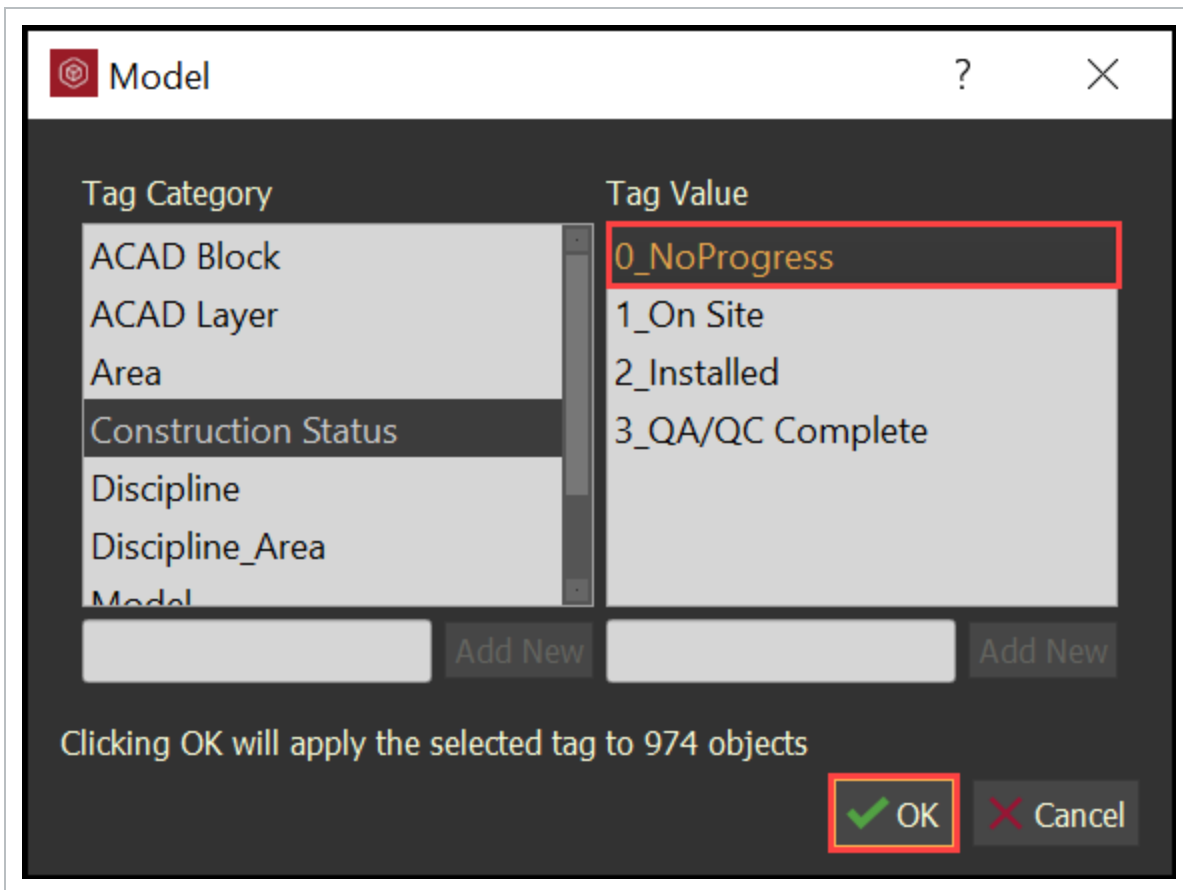

NOTE Clicking OK will apply the selected tag to the actively selected objects.

TIP If the desired tag category or value is not available, then simply create it, then select **OK**.

7.4.2 REMOVING TAGS

Quickly remove tags from model objects.

7.4 STEP BY STEP 2 – REMOVING TAGS

1. Select desired model objects.
2. Right click to view the **Selection Menu**.
3. From the Selection Menu, select the tags you want to remove from your selected objects.

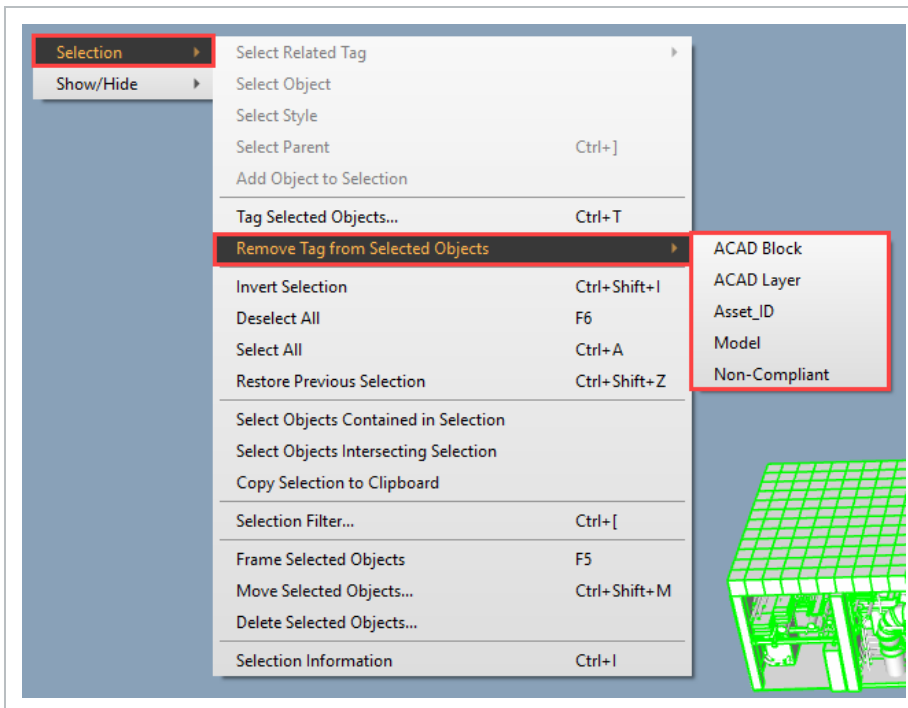

7.5 COPY METADATA FROM MODEL TO EXCEL

Metadata can be copied from your model into Excel by selecting the whole model or specific parts of the model, copying that data to the clipboard, and then pasting that data into excel.

The following step-by-step walks you through how to copy metadata from Model to Excel.

7.5 STEP BY STEP 1 – COPY METADATA FROM MODEL TO EXCEL

1. Select model objects.
2. Right-click anywhere in the viewer and select **Selection > Copy Selection to Clipboard**.

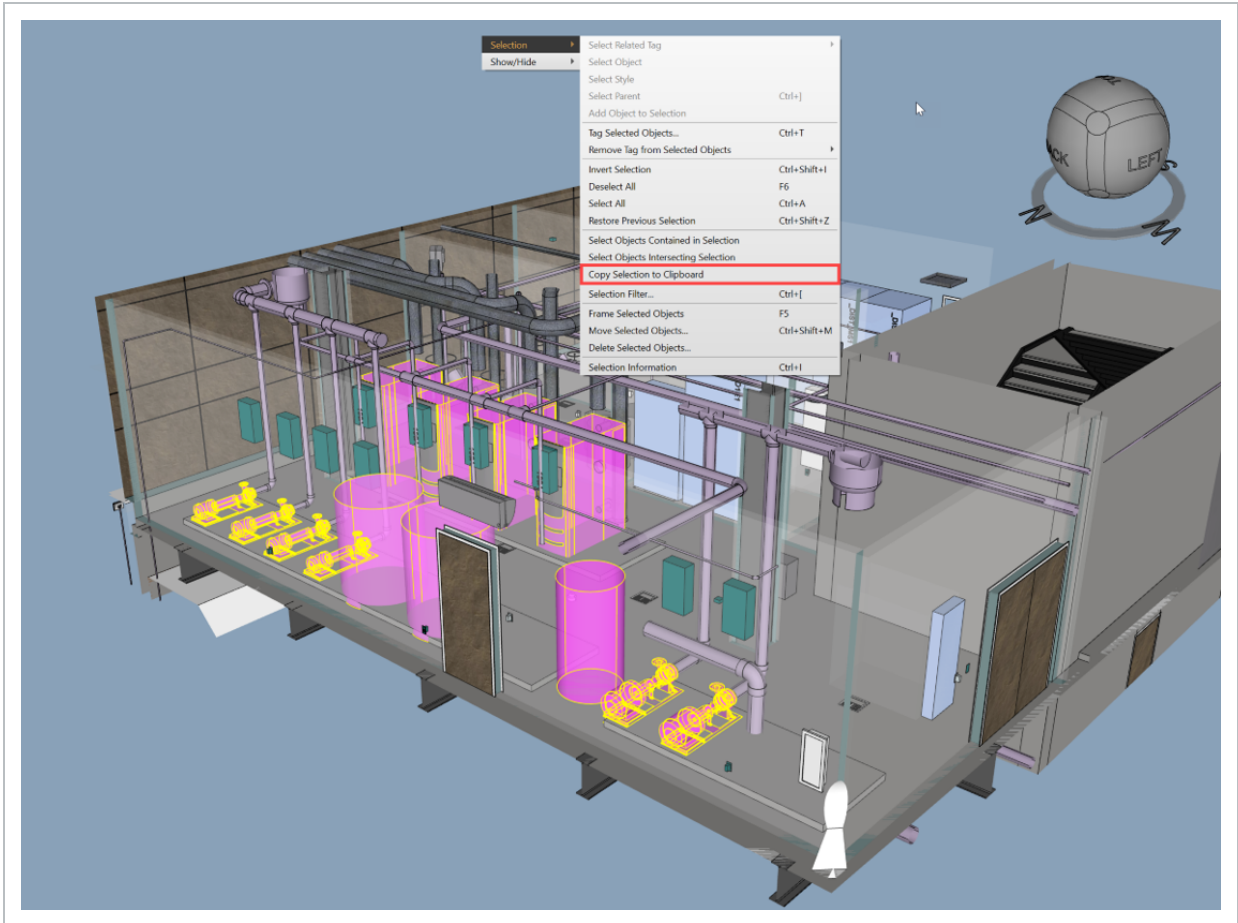

3. Open Excel, and then paste the copied items.

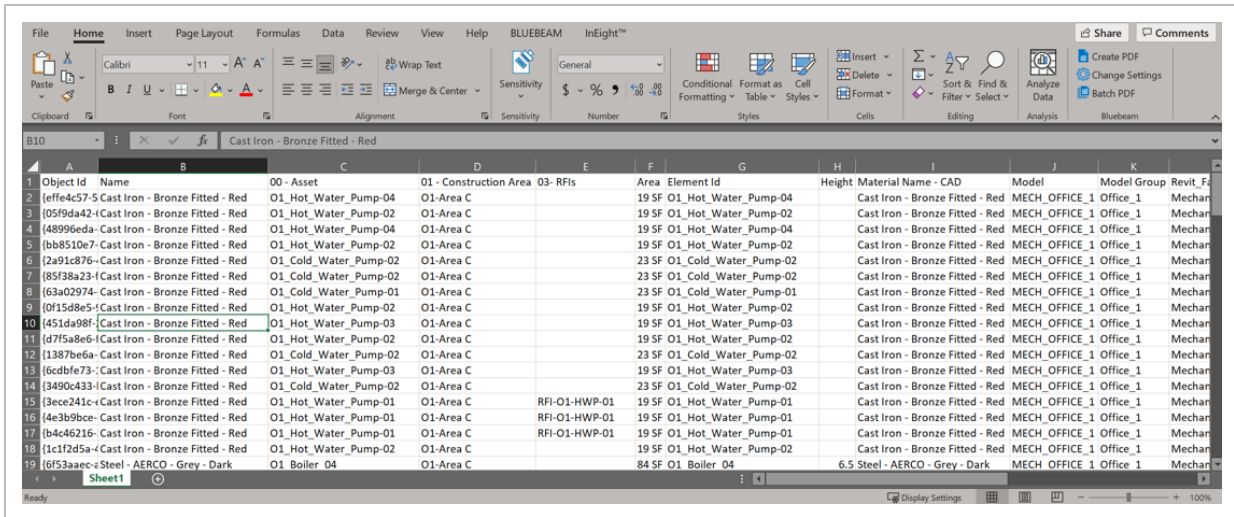

All metadata associated with the selected objects is now pasted into Excel.

7.6 TAG DATA EXPORTER

The Tag Data Exporter provides the ability to identify a Tag to pivot off of. It also lets you identify your desired related tags to include in an export of model metadata into a CSV file. The configurations can be saved for repeatable use. These configurations can also be imported and exported as needed for other projects.

7.6 STEP BY STEP 1 – EXPORT TAG DATA TO CSV FILE

1. Right-click the **Tags** tab in the Tags and Objects panel.
2. Select **Tag Data Exporter....**



3. Select a **Tag**, and then move it to the **Identifier/Pivot Tag** field.

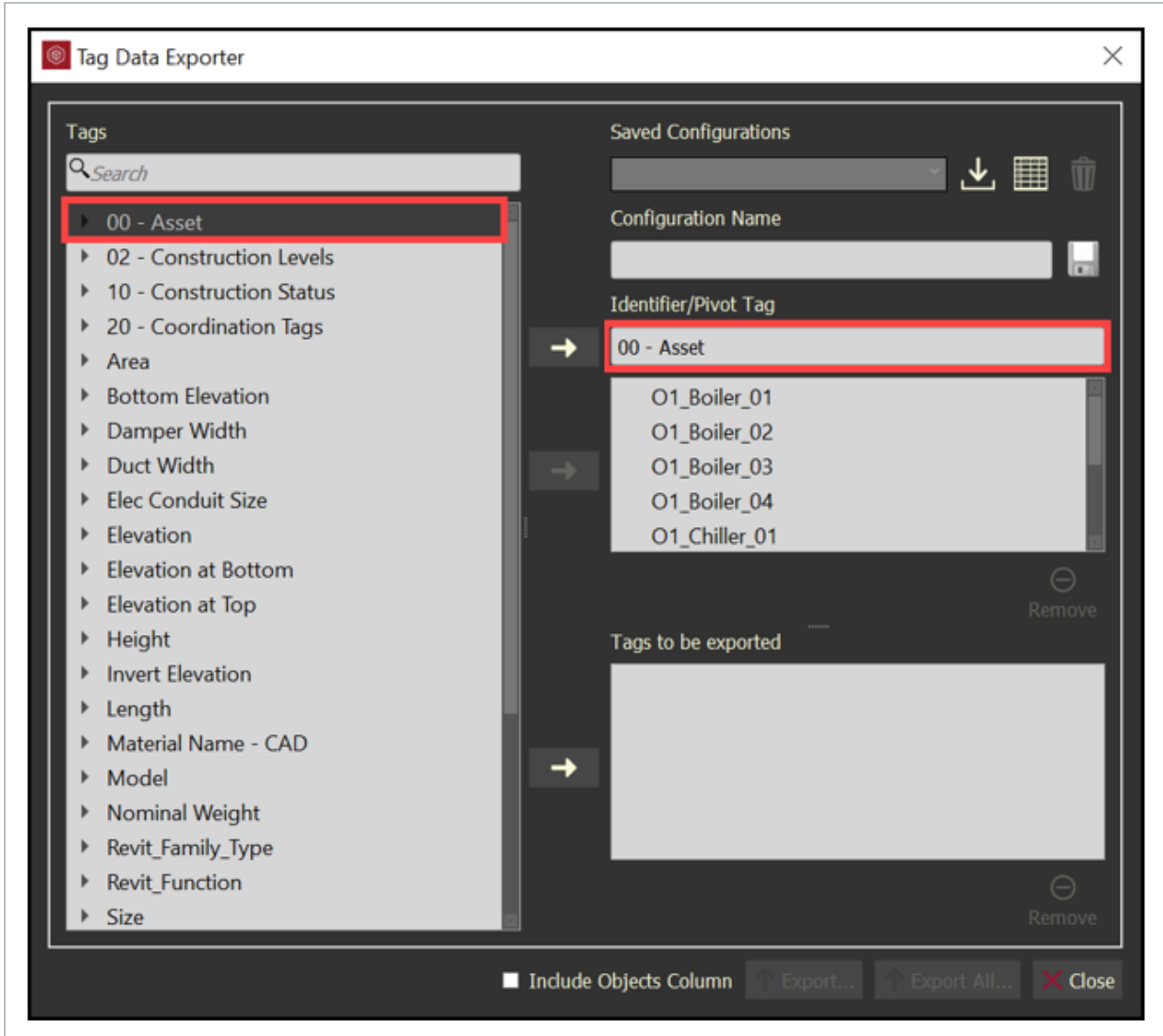

4. You can be specific with the Tag values by removing any values that you do not want to be a part of the export. Select the tag values, and then click **Remove** .

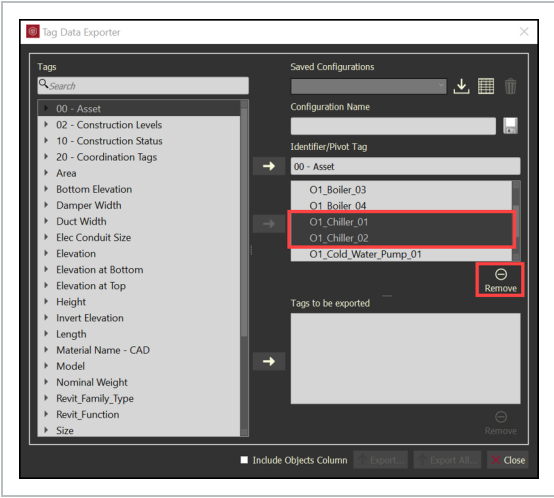

- 5. You can also be specific with the Tag values by selecting your values, and then moving them into the Identifier/Pivot Tag area.

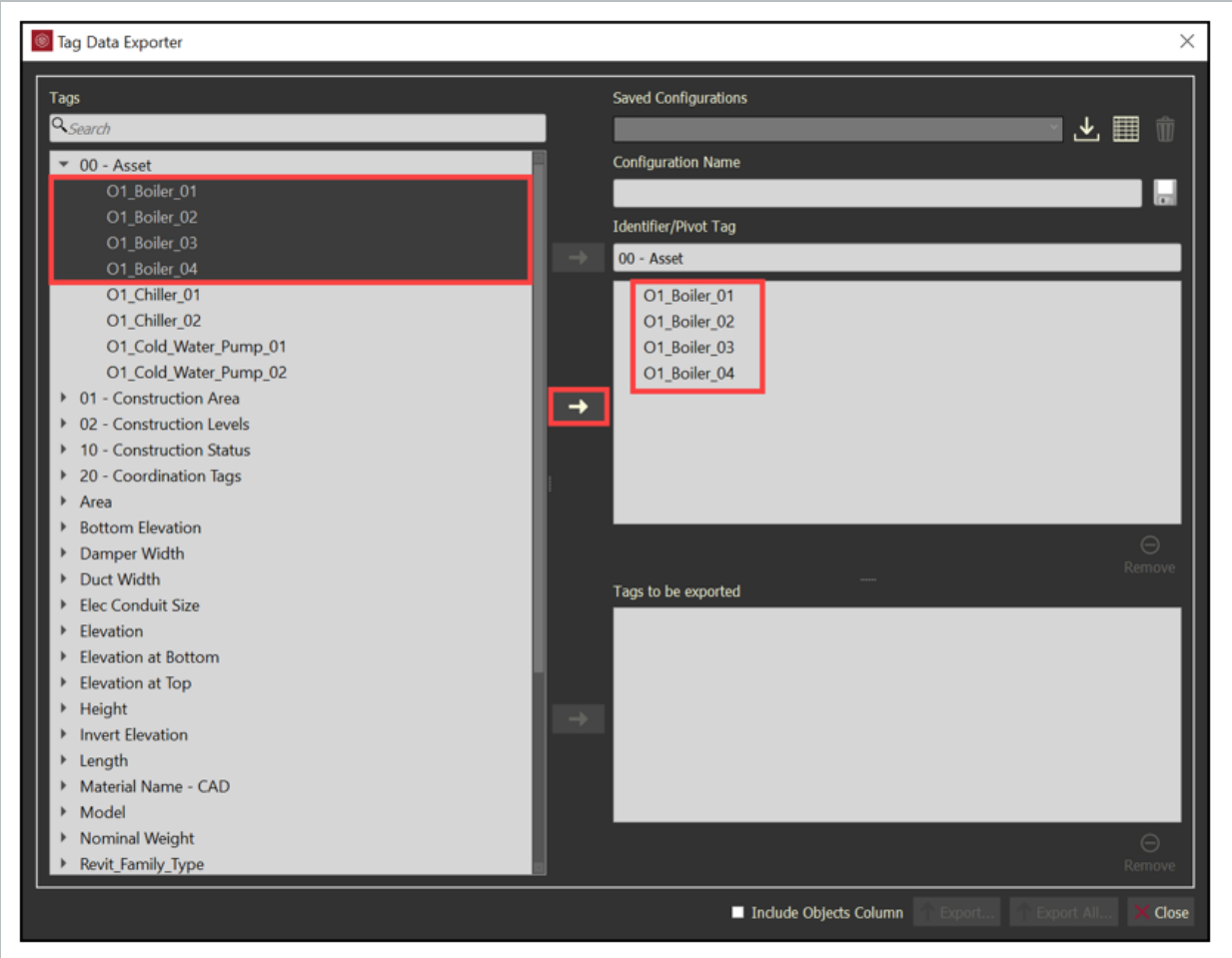

6. Select additional **Tags**, and move them to the **Tags to be exported** field.

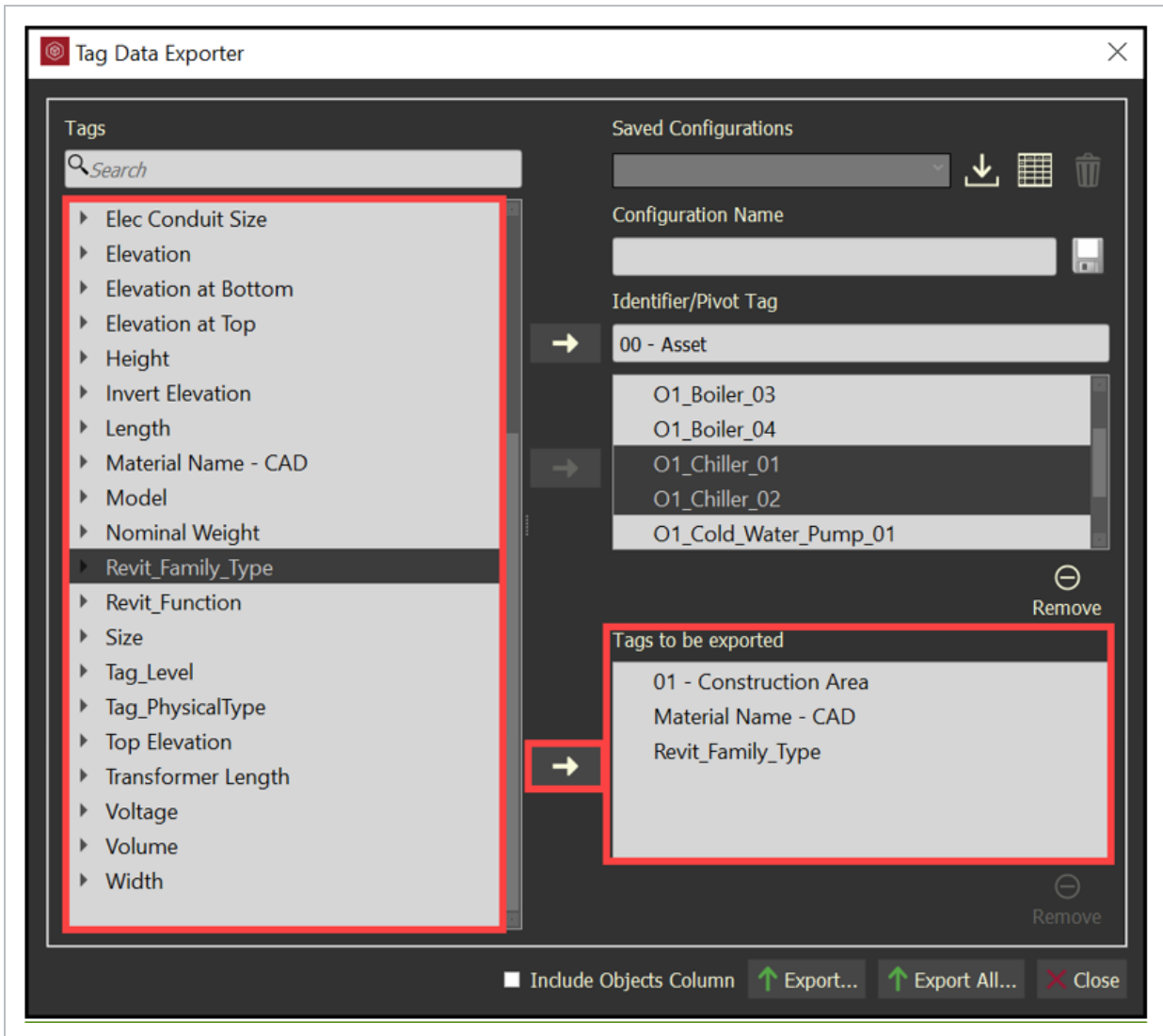

7. Enter a **Configuration Name** and click **Save** to access this configuration again.

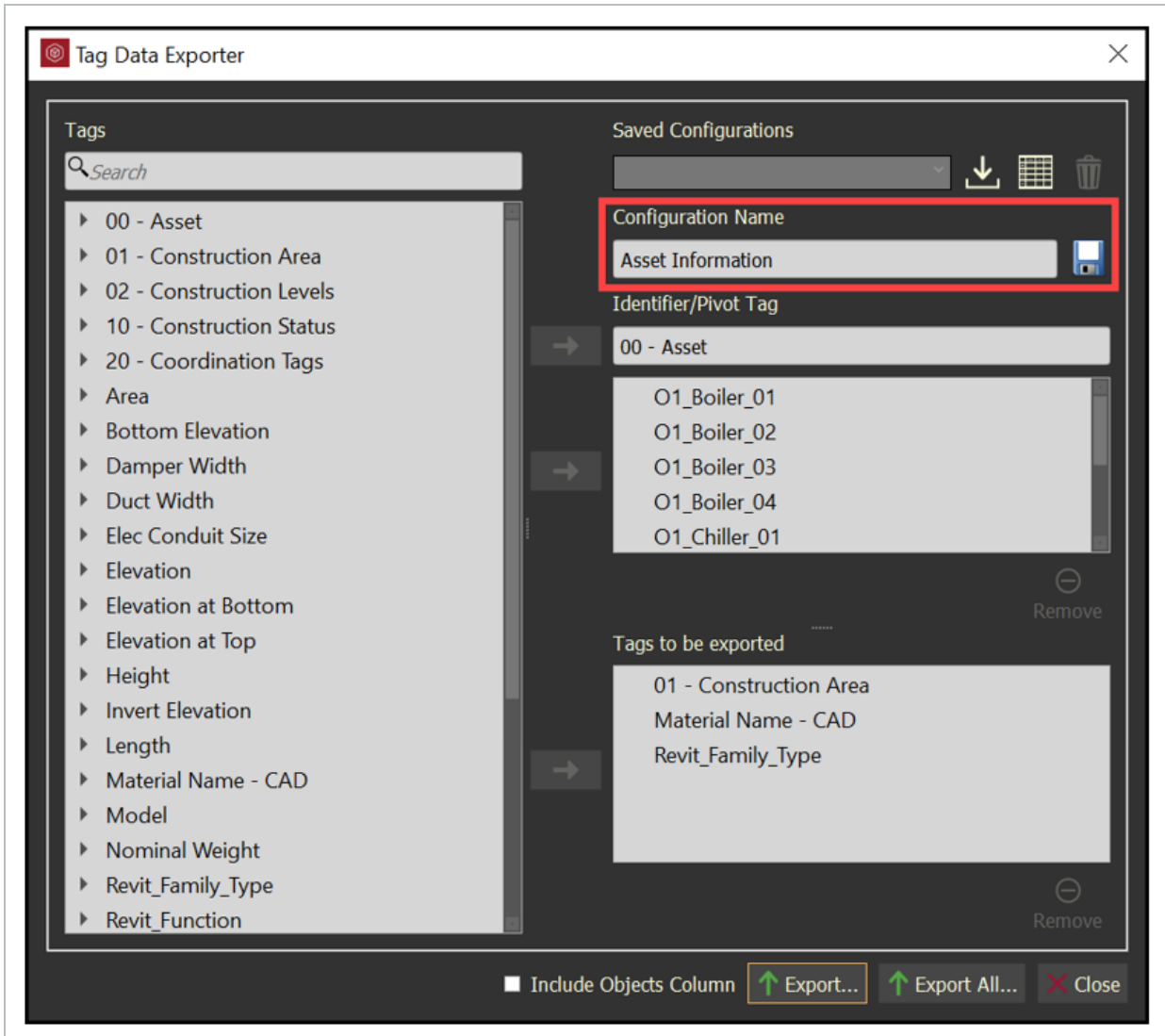

8. The saved configurations can be imported, exported, and deleted.

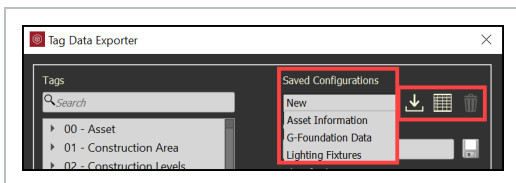

9. Toggle the **Include Objects Column** if you want the data exported to be combined into like rows according to the data with a leading column providing a count of objects meeting that row of data.

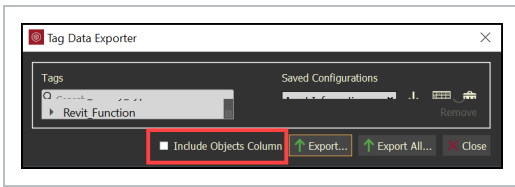

10. Click **Export All...** to export all data related to the configuration into a CSV file.
11. Click **Export...** to only export data related to the configuration and the model objects currently selected.
 - CSV file with the Object Column

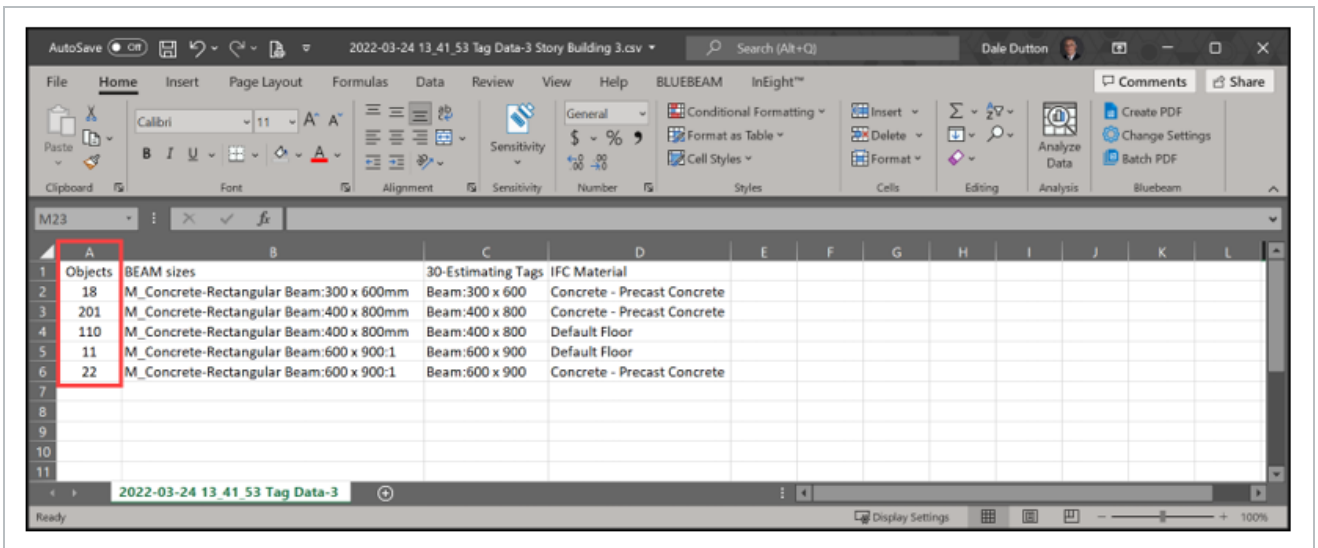

- CVS file without the Object Column

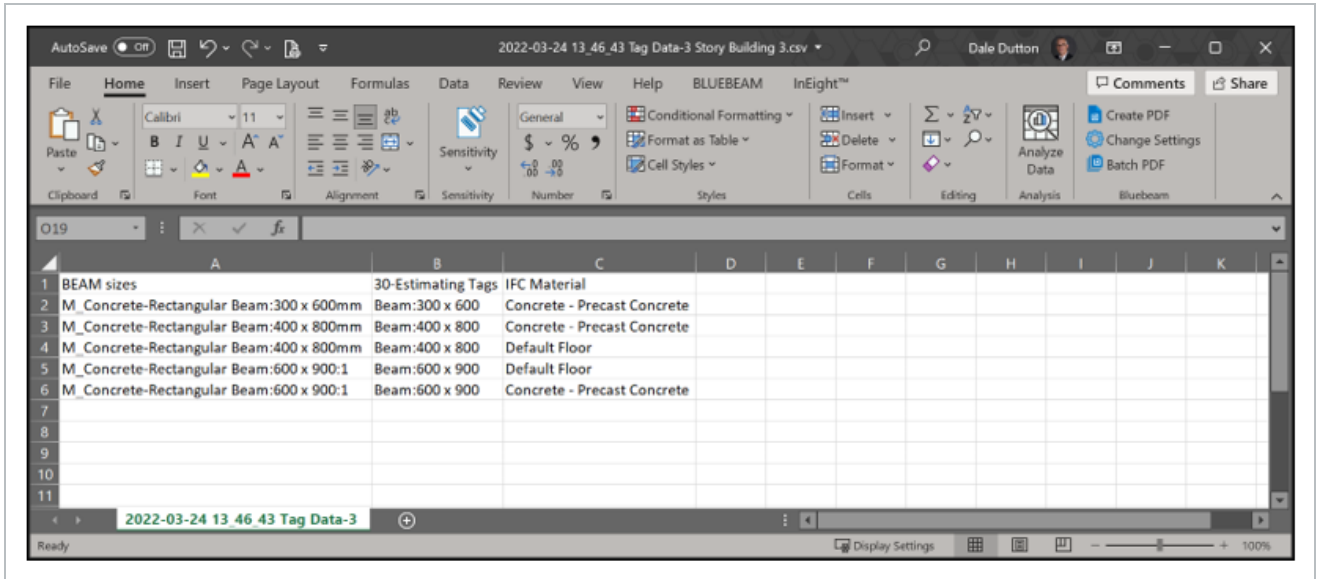

7.7 IMPORT TAGS FROM EXCEL

Custom Tags can be imported from Excel into the model.

Within Excel, one column needs to contain a unique tag for the Category Tag / Category Values that exist within the model.

Assign custom created tags to model objects to enrich the model with actionable metadata.

7.7 STEP BY STEP 1 – IMPORT TAGS FROM EXCEL

1. Establish Unique ID information within excel. (i.e., Asset_ID in column A.)

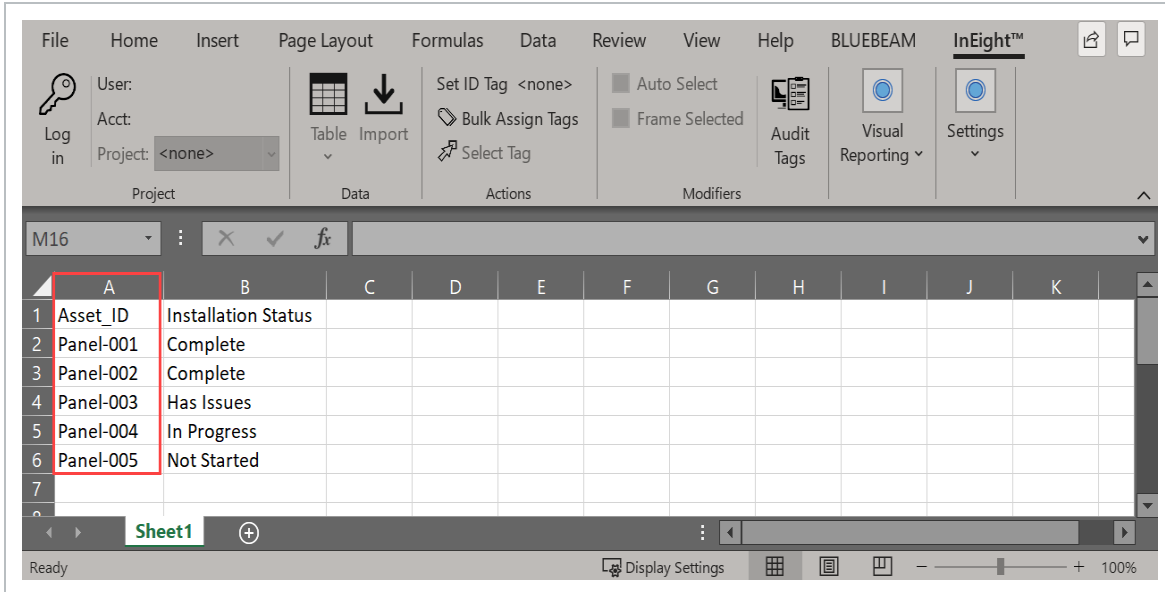
**NOTE**

Asset_ID has to be an existing Tag Category along with the information in cells A2 thru A20 must be existing Tag Values within the model.

Asset_ID cannot have any duplicates.

Model Objects must be assigned to the Unique ID.

2. Establish metadata to import into the model. (i.e. Installation Status in column B)

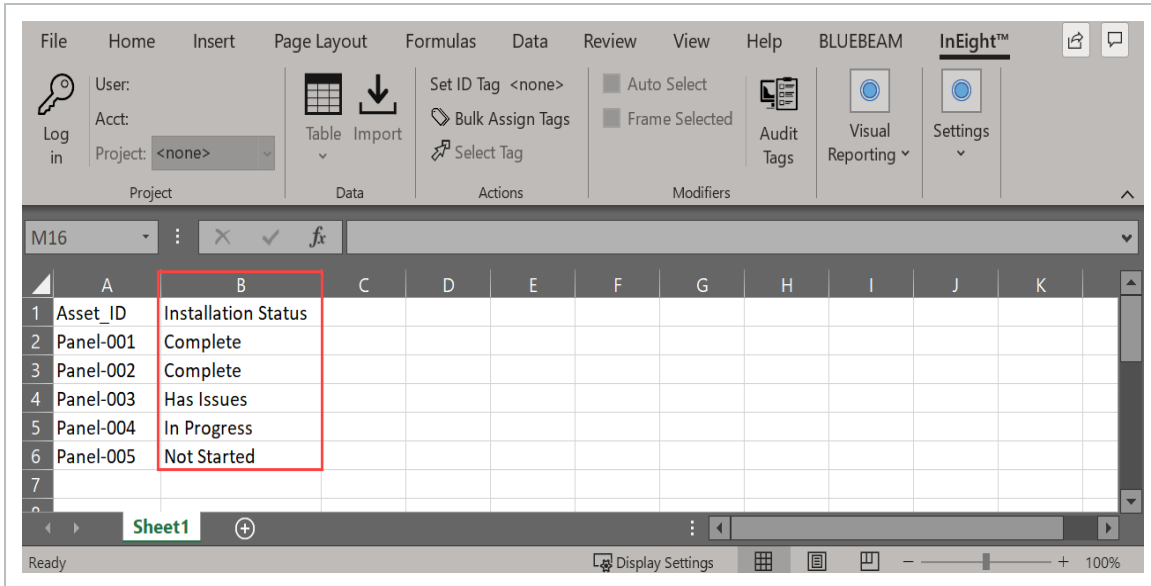

3. Select the InEight tab within the Excel ribbon.

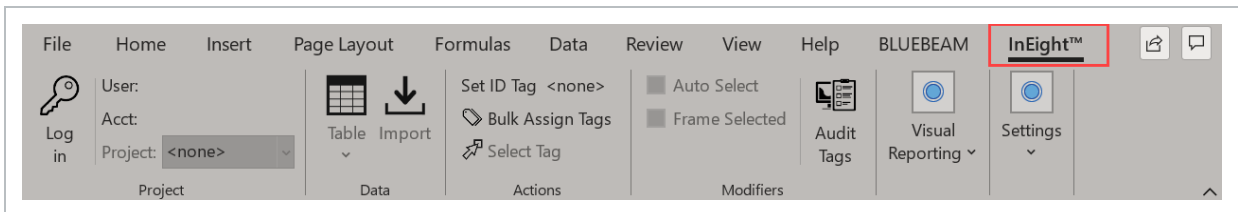

4. Select a cell within the Unique ID column.

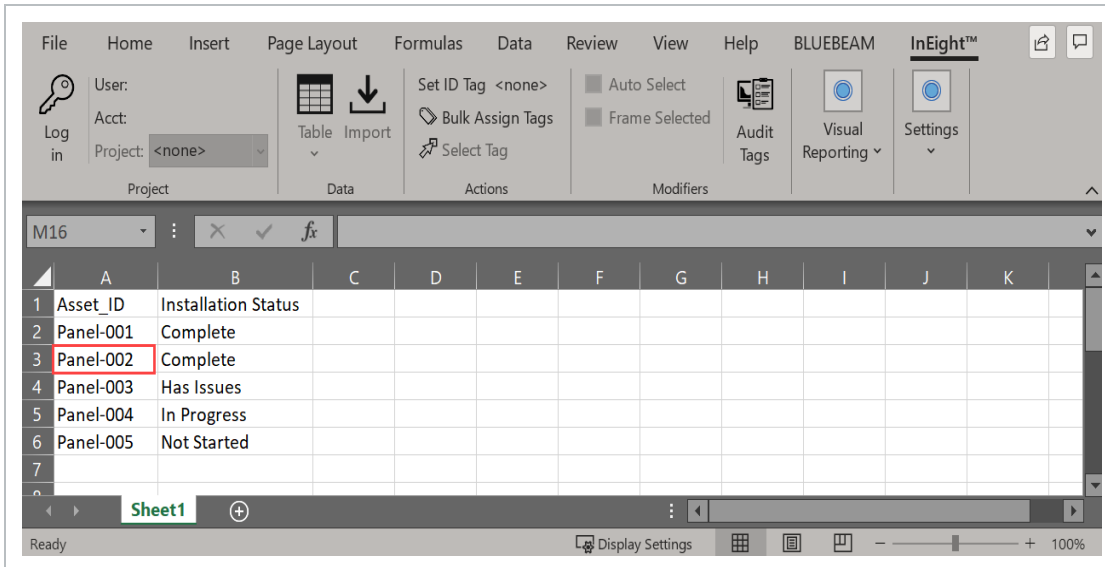
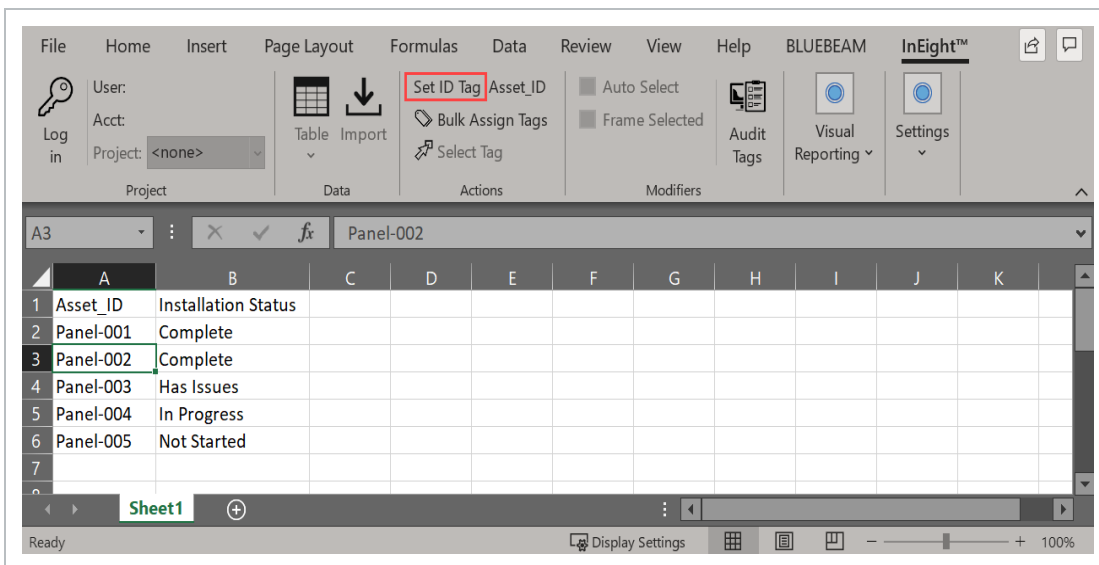
5. Within the Actions menu, select **Set ID Tag**.**NOTE**

The Set ID Tag will change from <none> to the column header. (i.e. Asset_ID)

6. Select a range of cell(s) within the column of data to import.

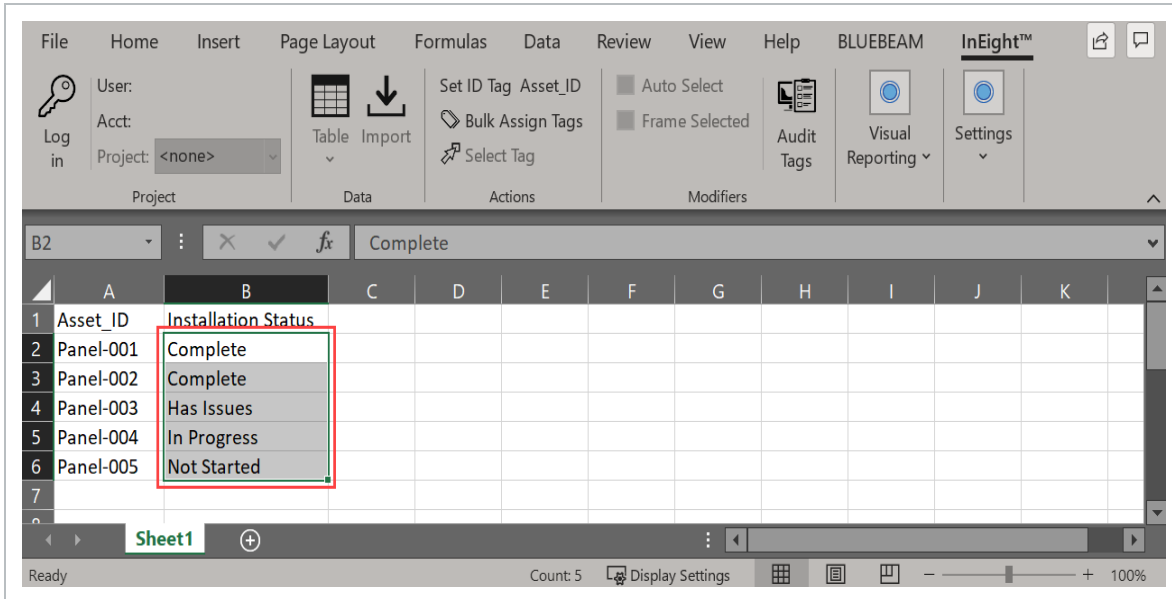

7. Within the Actions menu, select Bulk Assign Tags.

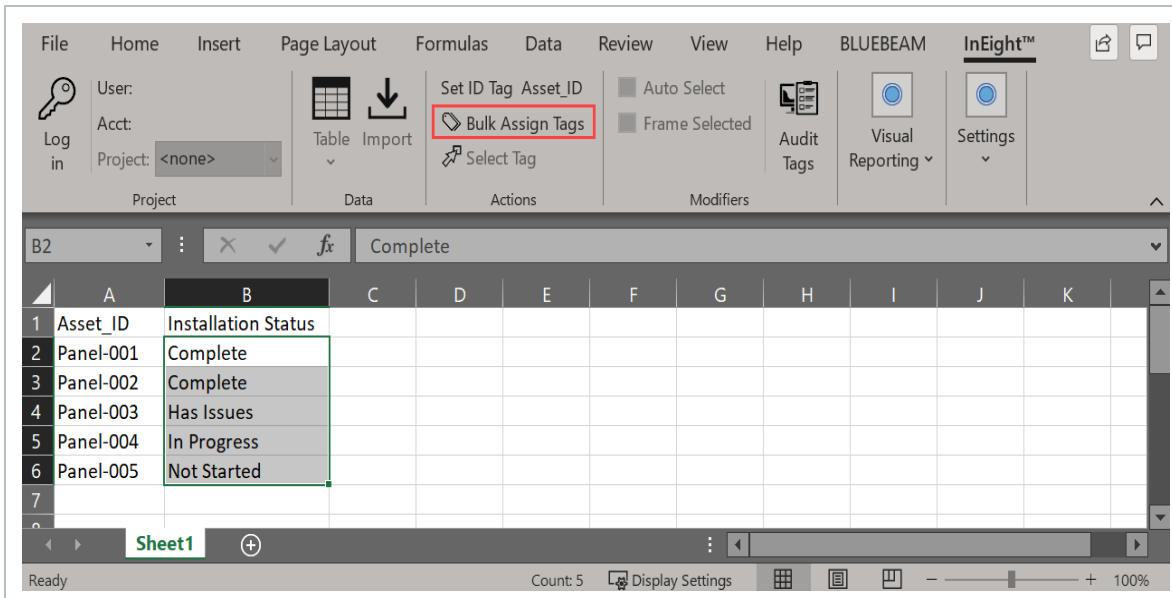

8. Import multiple columns of metadata, by selecting a range of cells that span columns.

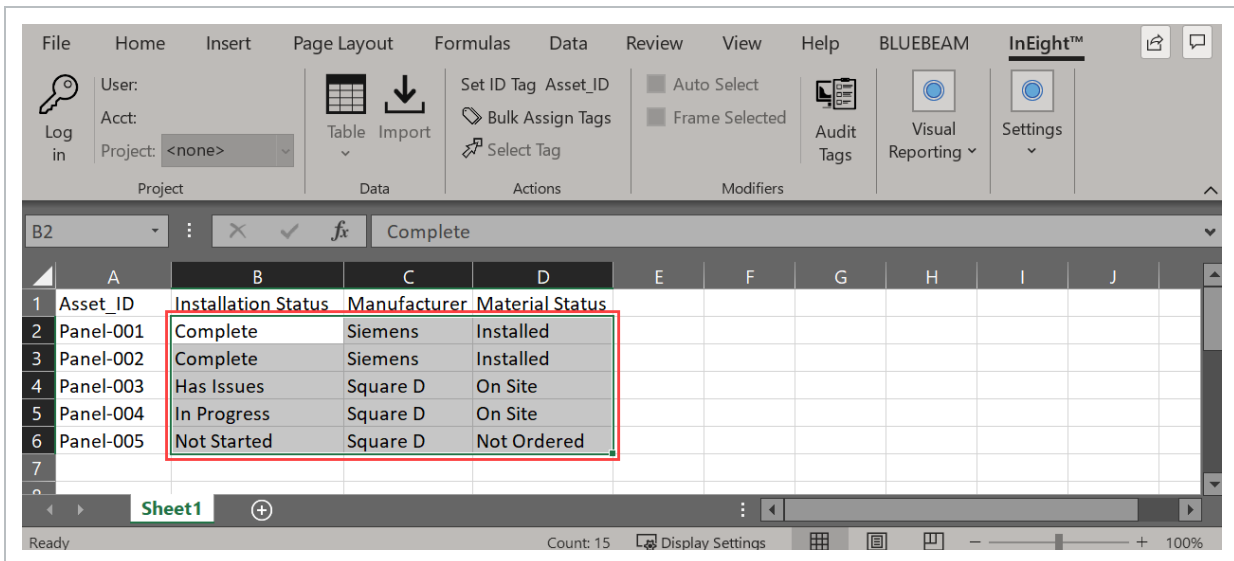

9. Within the Actions menu, select **Bulk Assign Tags**.

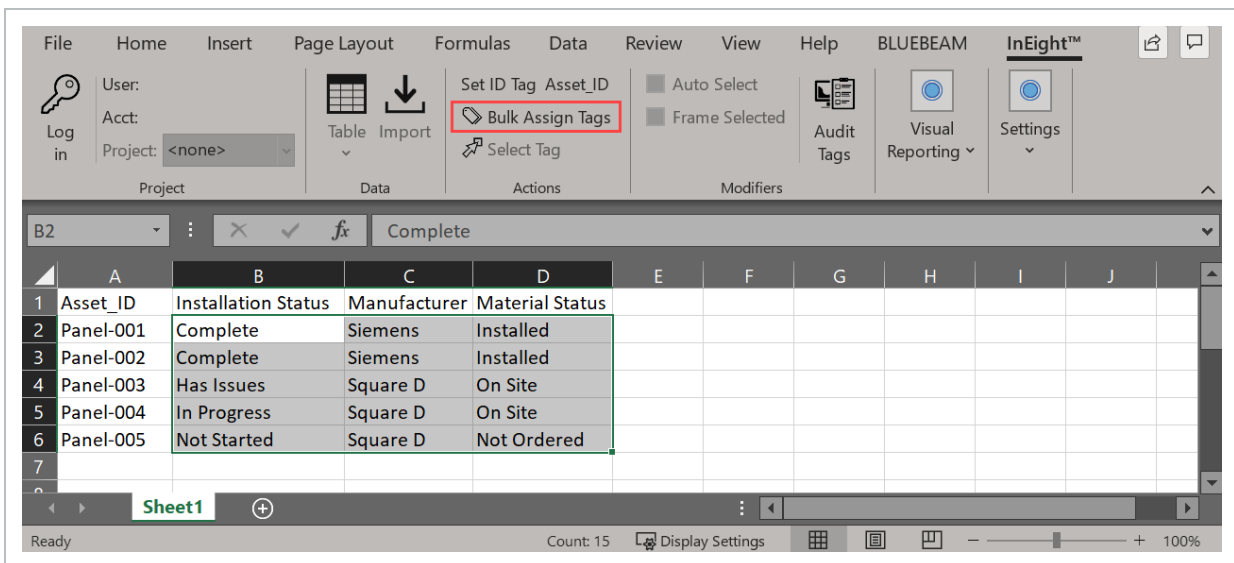

NOTE

There will be NO indication notice that the data has been imported.

10. Results:

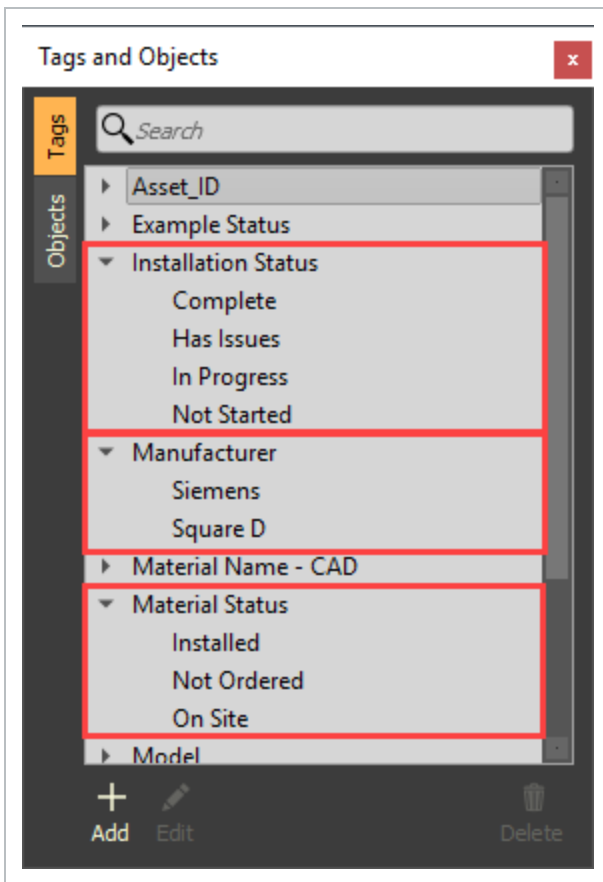

7.8 SELECT MODEL OBJECTS VIA EXCEL

Model objects can be auto-selected and framed in the model viewer by selecting tag values in Excel. In Excel, the top row represents the Tag Category. Any row below the top row represents the Tag Value. The Tag Category and Tag Value must be exactly the same in Model in order for Excel to interact with Model.

The following step-by-step walks you through how to auto-select Model objects in Excel.

NOTE The following steps require the Excel Plugin to be installed.

7.8 STEP BY STEP 1 – SELECT MODEL OBJECTS VIA EXCEL

1. From Excel, select the **InEight** tab from the top menu.
2. Under the Project section, Click **Login**.
The Login to InEight dialog box opens.
3. Login using the same credentials for InEight Model.

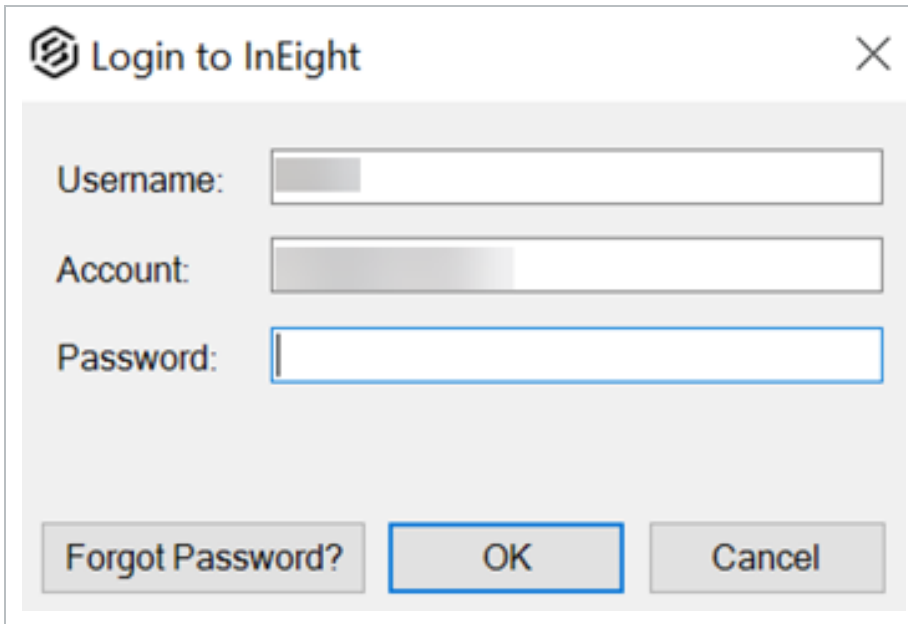

The screenshot shows a dialog box titled "Login to InEight" with a close button (X) in the top right corner. It contains three input fields: "Username:", "Account:", and "Password:". Below the input fields are three buttons: "Forgot Password?", "OK", and "Cancel". The "OK" button is highlighted with a blue border.

4. Select the project you are currently in, and then click **OK**.
5. In Excel under the InEight tab in the Modifiers section, select the check marks for both **Auto Select** and **Frame Selected**.

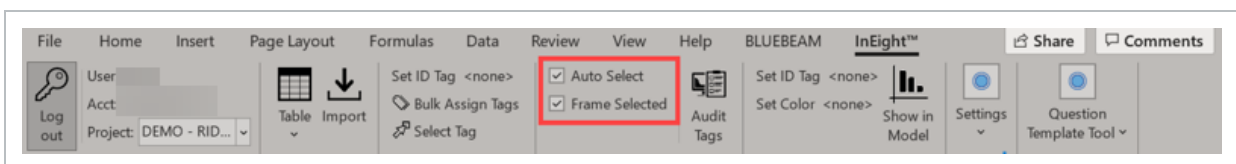

6. Select a tag value from the metadata copied from the Model into Excel.
7. In the Actions section, click **Select Tag**.

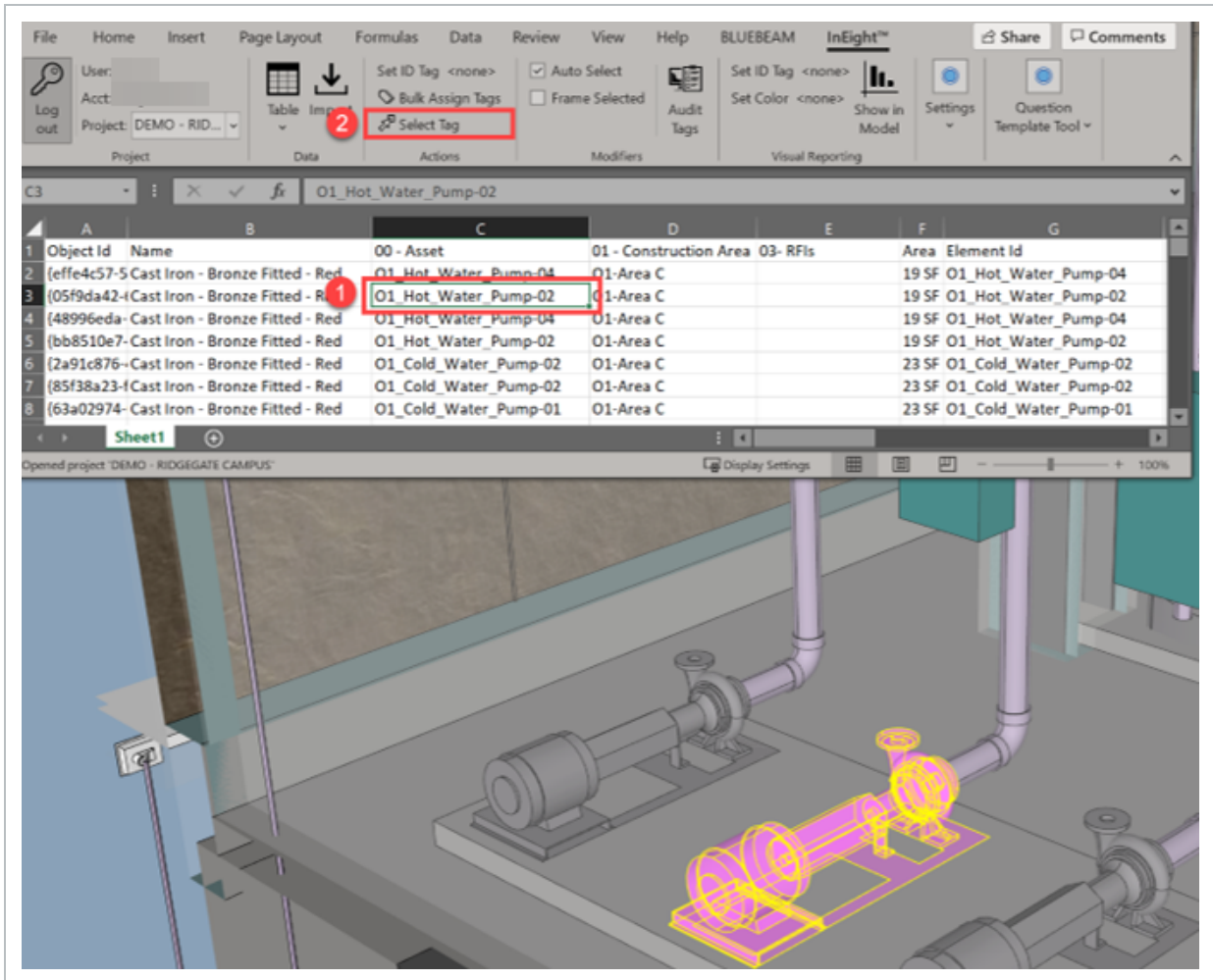

7.9 CREATE TABLES OF EXTERNAL DATA

NOTE Only a Project Admin can create Generic Tables to import external data and link to a Unique ID Tag in Model.

External information can be accessed in Model but is managed externally using Excel.

7.9.1 IDENTIFY THE MODEL UNIQUE ID

The following step-by-step walks you through how to identify the model Unique ID in Excel.

NOTE The following steps require the Excel Plugin to be installed and for a Project Admin to be logged into the InEight Excel Plugin.

7.9 STEP BY STEP 1 – IDENTIFY THE MODEL UNIQUE ID

1. After you log into Excel, use the first column (cell A1) to match a Tag Category in Model.

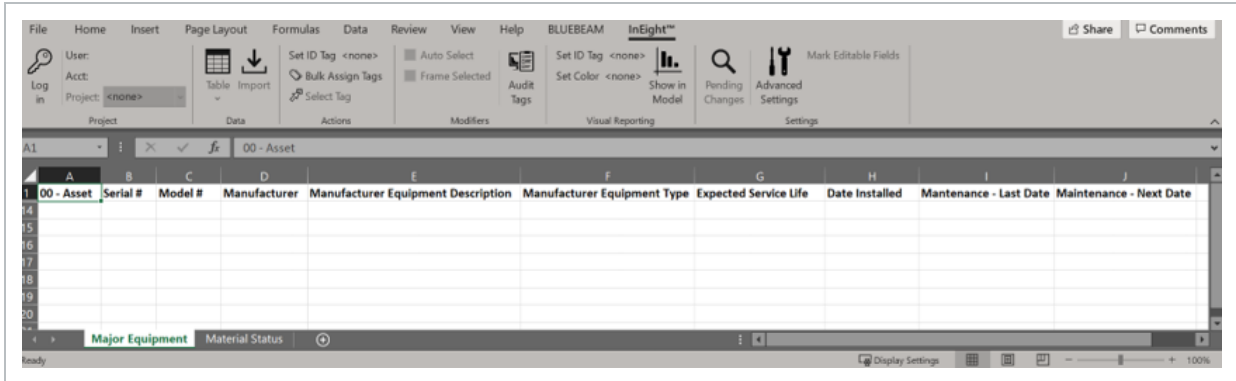

Columns B and beyond can contain additional columns of data as needed.

2. Rename the Tab to the preferred Table Name.
Although this is not a required step, it can provide clarity as you develop the extra data.
3. Under the InEight tab in the Data section, select **Table**.
4. From the drop-down menu, in the New Table section, select **Create new Table**.

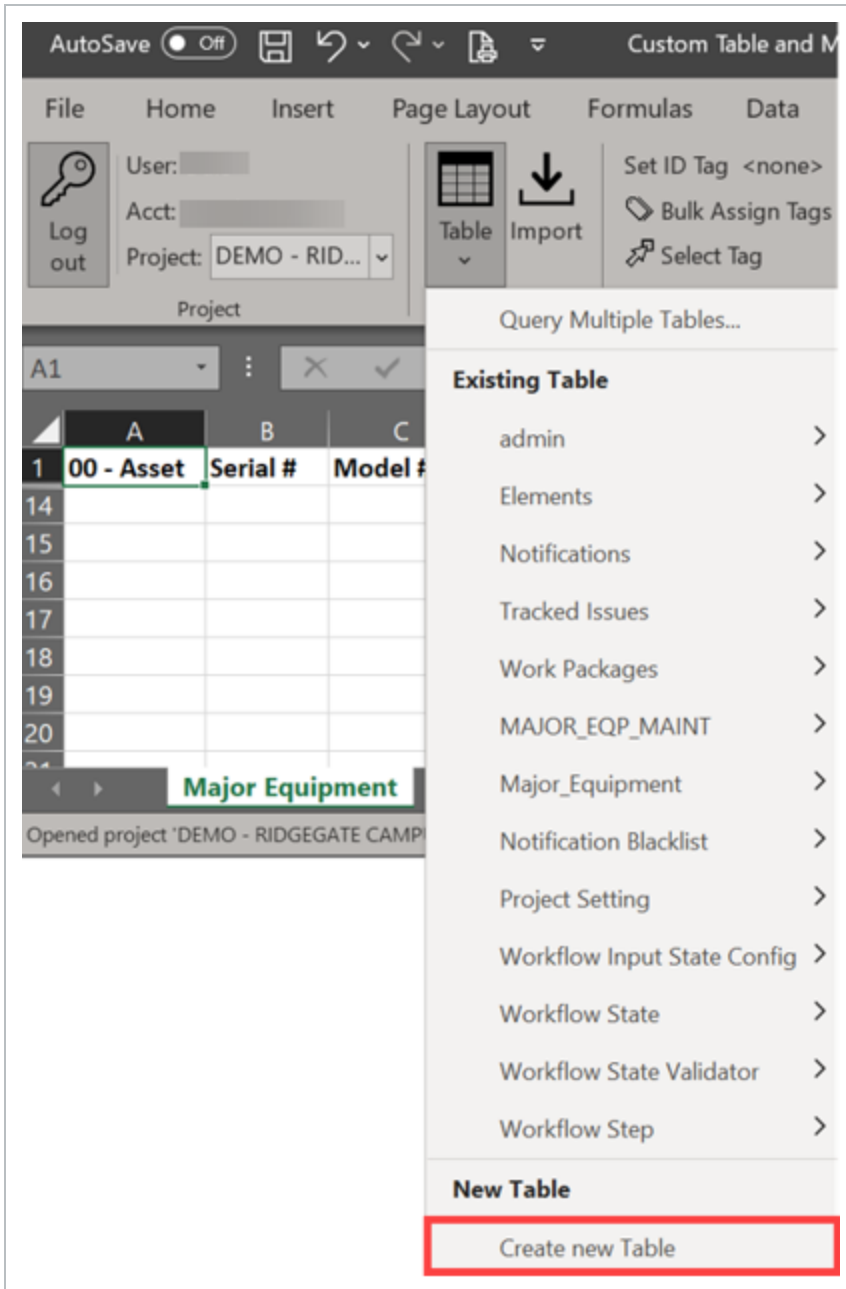

5. From the Create new Table data box:
 - a. Select the check mark for **Use headers from current Excel worksheet.**
 - b. Confirm the **Schema Name** is labeled with the preferred name with no spaces.

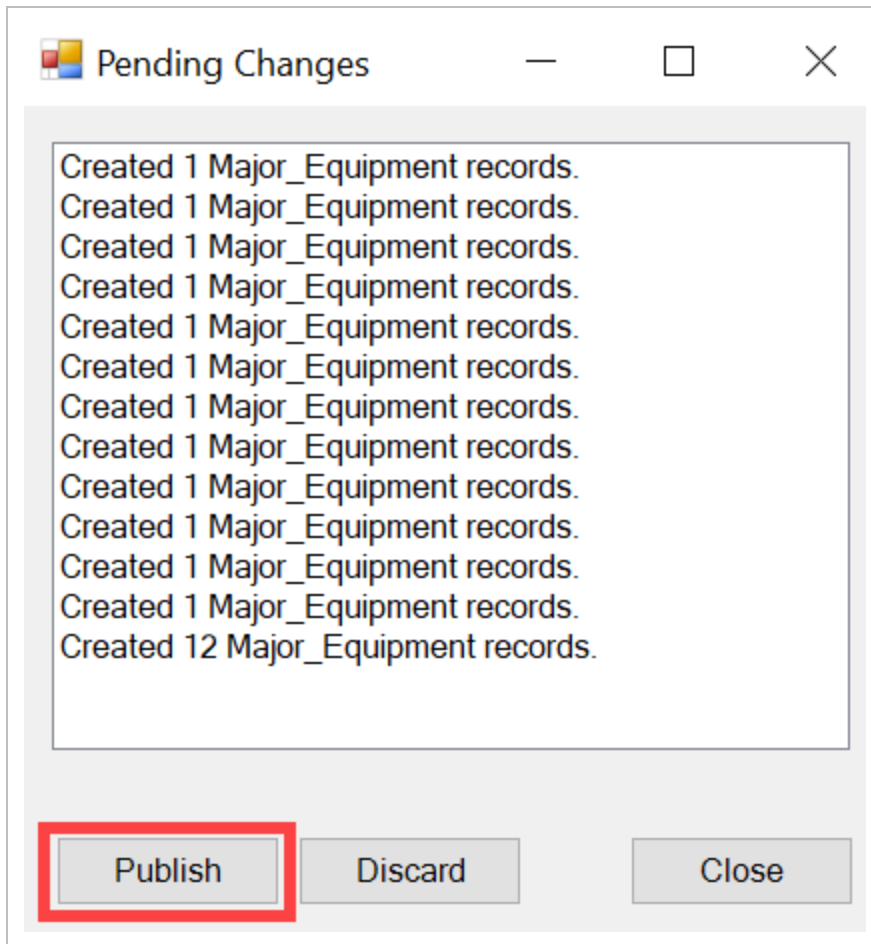

7. In the Data Type column, choose the correct Data Type for each Column Name.

NOTE All data types are defaulted to Short String.

- **String**: can contain any sequence of characters
- **Integer**: a whole number (not a fractional number) that can be positive, negative, or zero (-5, 1, 5, 8, 97, 3243)
- **Location**: GPS latitude and longitude coordinates
- **Short String**: can contain any sequence of characters limited to 32 characters
 - If this is chosen, make sure that your data will not extend beyond 32 characters or you will encounter an error when uploading data.
- **TimeStamp**: a seven part value representing a date and time by year, month, day, hour, minute, second

- **GUID:** Global Unique ID
- **Unsigned Integer:** often called units which are zero or positive numbers
- **Long Integer:** longer than an integer
- **Float:** a number that is not an integer, because it includes a fraction in decimal format
- **Double:** can represent a fractional and whole values and can use exponential notation (1.0e6 to represent one million)

NOTE

You can add or remove any of the column name fields.

8. After all Column Name fields have the preferred Data Type, select **OK** to create the Generic Table.

The new tab is then shaded in red to show that it is now a table available in the Model database.

Three new fields also show: Created By, Created On and Property ID.

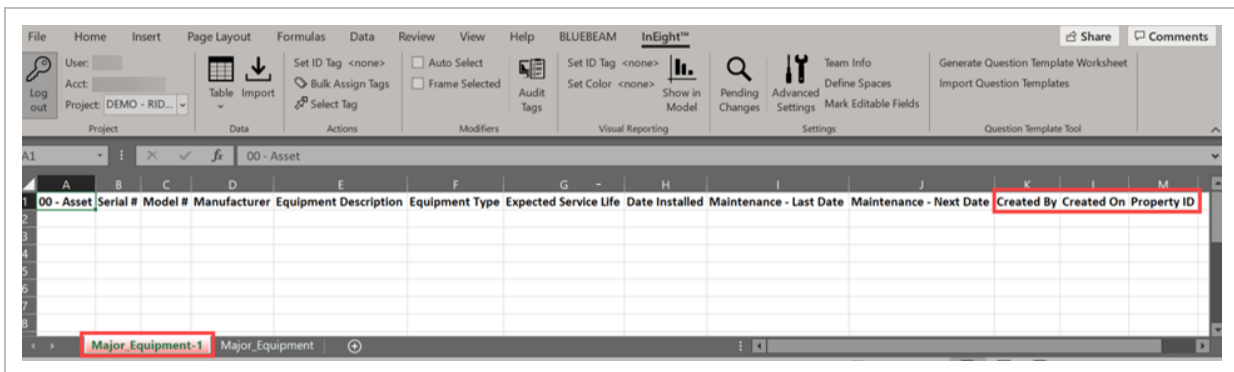

7.9.2 ADD INFORMATION TO GENERIC TABLE

The following step-by-step walks you through how to add information to the generic table.

7.9 STEP BY STEP 2 – ADD INFORMATION TO GENERIC TABLE

1. Open Excel and log in.
2. Under the InEight tab in the Data section, select **Table**.

3. Under Existing Table, select the name of your newly created Generic Table, and then select **Query All**.
4. In the Identifier column or the Unique ID, fill in the data from the model.

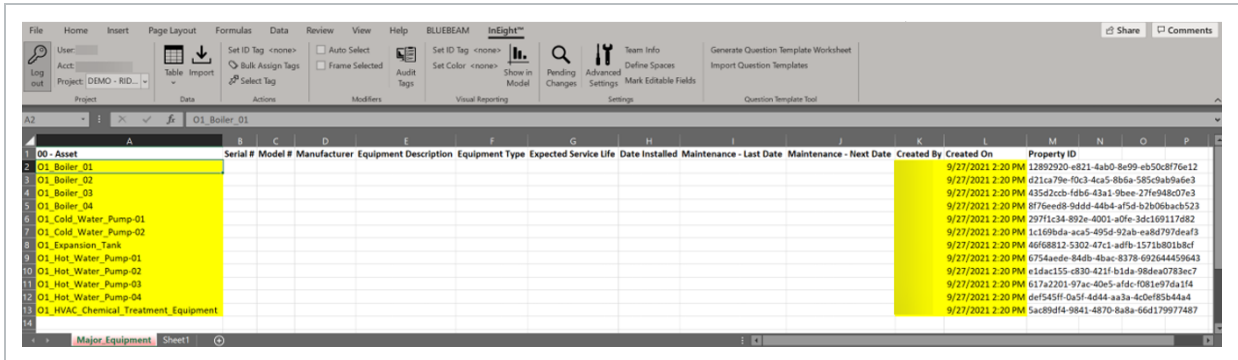

The new information is then highlighted in yellow. This shows that the information has been added or modified but not yet saved to the database table.

5. Under the InEight tab in the Settings section, click **Pending Changes**.

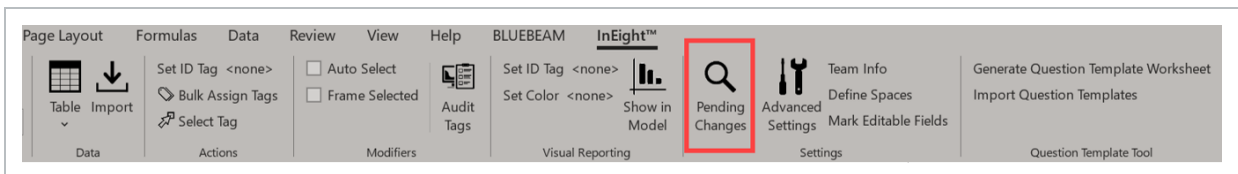

6. Click **Publish**.

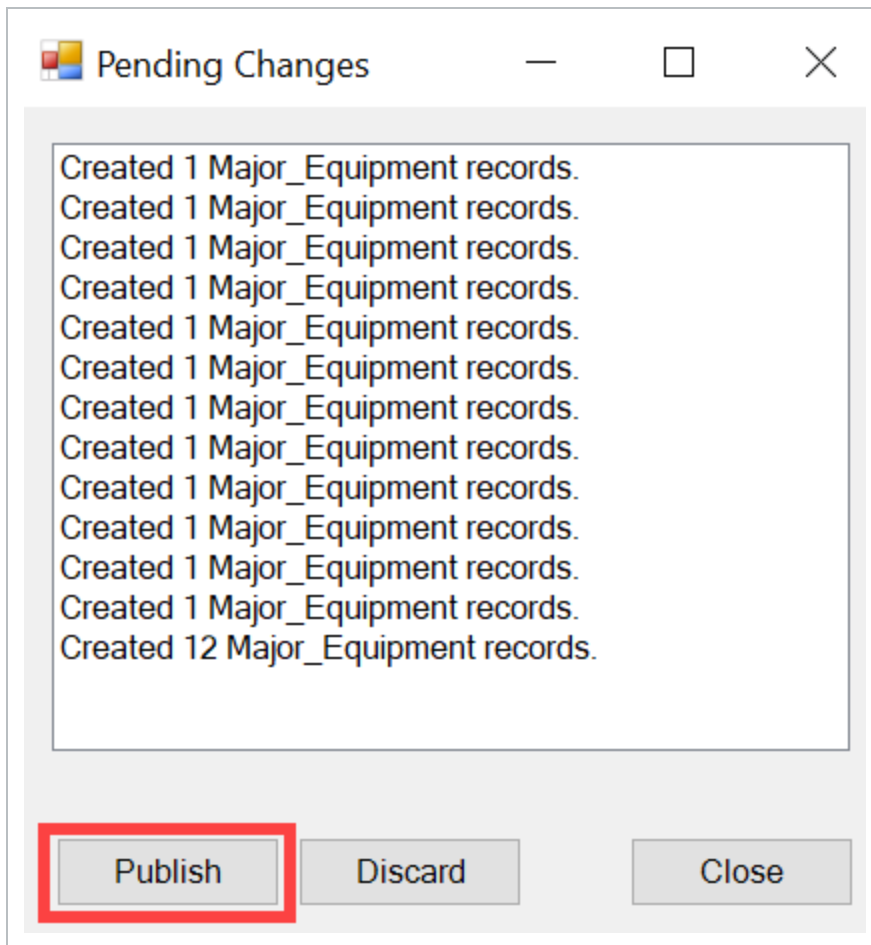

The database table is now updated.

7. Fill in any additional data throughout the project as needed.

7.9.3 IMPORT INFORMATION TO GENERIC TABLE

The following step-by-step walks you through how to import information into the generic table.

7.9 STEP BY STEP 3 – IMPORT INFORMATION TO GENERIC TABLE

1. Open Excel and log in.
2. In Excel, select the spreadsheet tab containing the preferred data that needs to be uploaded into a table.

- Under the InEight tab in the Data section, select **Import**.

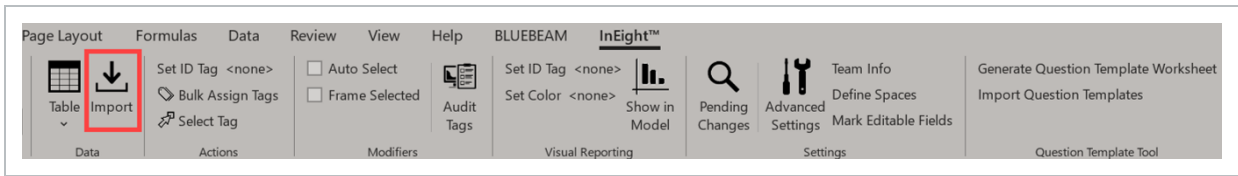

- In the Import Records dialog box, select the Table schema that you want to upload data into.
- When a warning dialog box appears, select **OK**.

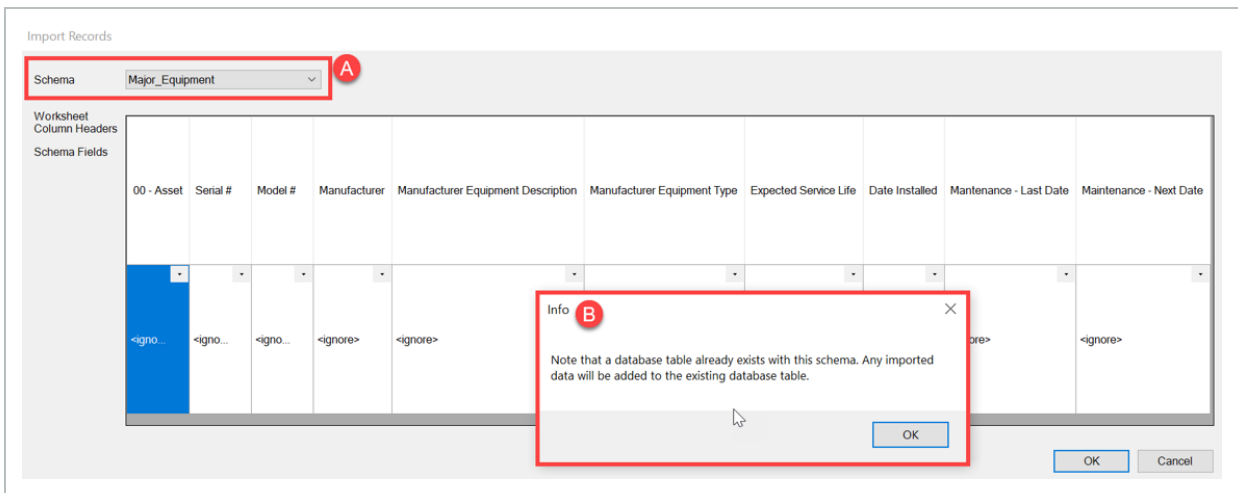

The Generic table opens with the new data added.

- Under the InEight tab in the Settings section, select **Pending Changes**.

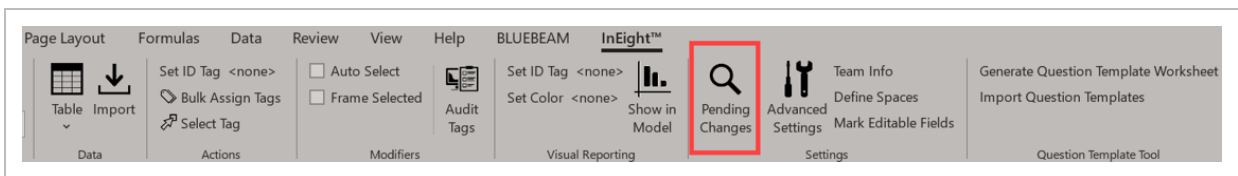

- Click **Publish**.

The database table is now updated.

7.9.4 REFRESH EXISTING TABLE DATA

Throughout the project, data might be updated by another user without notification that an update is happening. You need to refresh your table to see new information.

The following step-by-step walks you through how to refresh existing table data.

7.9 STEP BY STEP 4 – REFRESH EXISTING TABLE DATA

1. Open Excel and log in.
2. Under the InEight tab in the Data section, select **Table**.
3. Under Existing Table, select the name of your newly created Generic Table, and then select **Query All**.

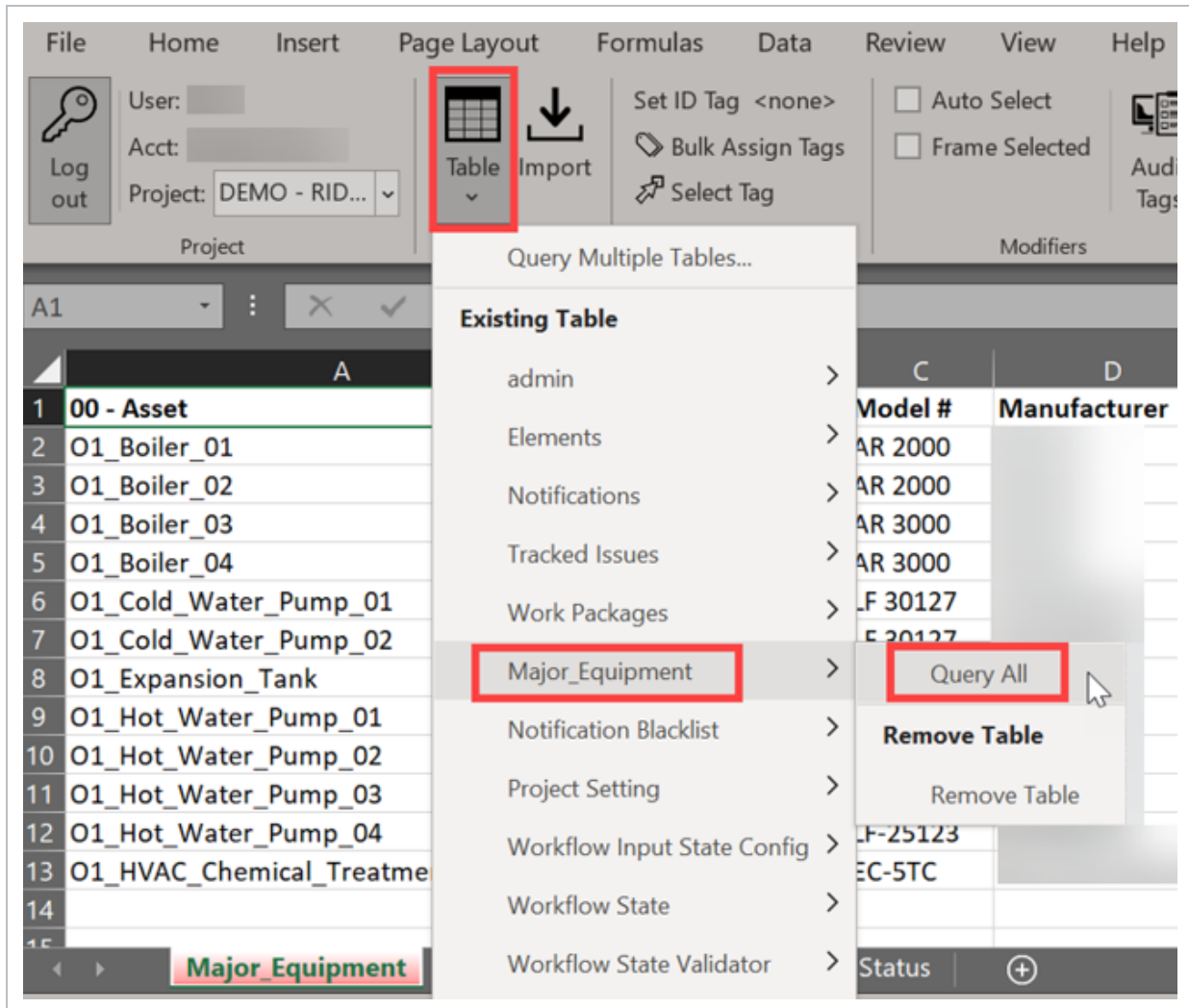

7.9.5 CLOSE DATABASE TABLES

The following step-by-step walks you through how to close database tables.

7.9 STEP BY STEP 5 – CLOSE DATABASE TABLES

1. Open Excel and log in.
2. Right-click the Excel spreadsheet table tab.
3. Select **Delete**.

Deleting the table tab only removes the local worksheet from Excel, but it does not remove database tables from your project.

You can also click the x in the top right of Excel. The InEight Excel Plugin dialog box opens showing available options.

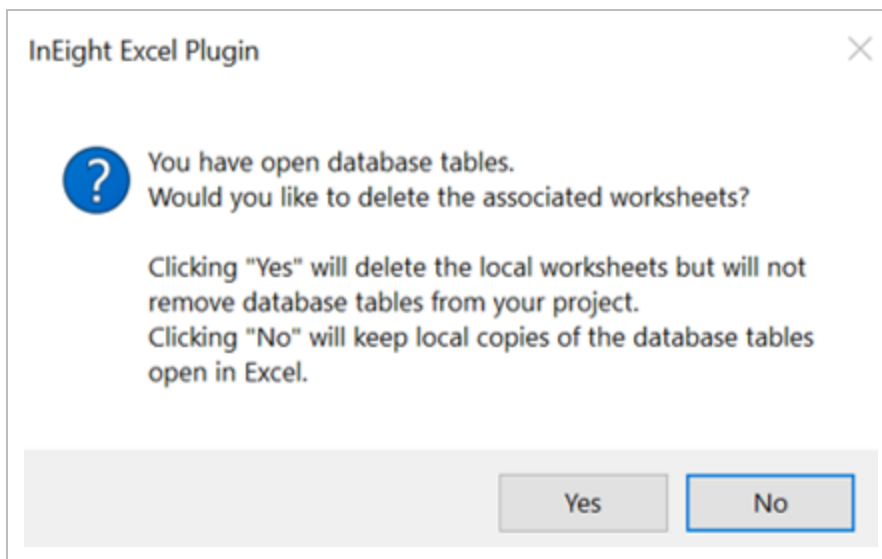

LESSON 7 REVIEW

1. How can you create Tags in InEight Model?
 - a. Manually create from Tags and Objects panel
 - b. Automatically create tags from the metadata of the Export / Import process
 - c. Manually import tags from an Excel file
 - d. All of the above

2. Tags are made up of what two components?
 - a. Category, Size
 - b. Size, Value
 - c. Value, Location
 - d. Category, Value

3. Deleting a tag that was created through the export / import process does not delete the tag until the **nexttime** you export / import to revise or update your model.
 - a. True
 - b. False

LESSON 7 SUMMARY

As a result of this lesson, you can:

- Create and edit static tags
- Create and edit dynamic tags
- Assign to and remove tags from objects

CHAPTER 8 – DATA TRANSFORMATION OPERATIONS

8.1 DATA TRANSFORMATION OPERATIONS (DTO) OVERVIEW

DTOs provide flexible and repeatable processes to maintain, normalize, add, validate, parse, and concatenate data. DTOs can be exported and imported from project to project to eliminate duplicate effort.

You can access DTOs from the main InEight Model window. Click Logic > **DTO**.

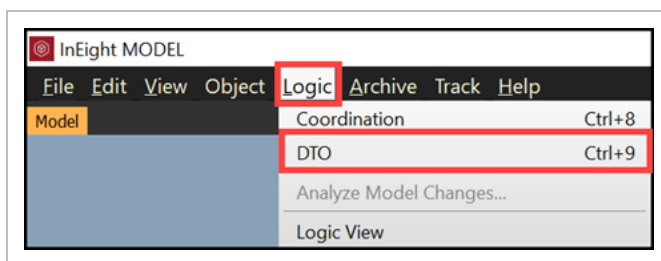

The Data Transformation Operations window has three tabs:

- **DTO** – Lets you create a tree structure of DTOs.
- **Selector** - You can select model objects from tags and object properties using specific criteria.
- **Action** – Lets you create, parse, concatenate, and quantify model data, and more through various functions.

8.1.1 DTO TAB

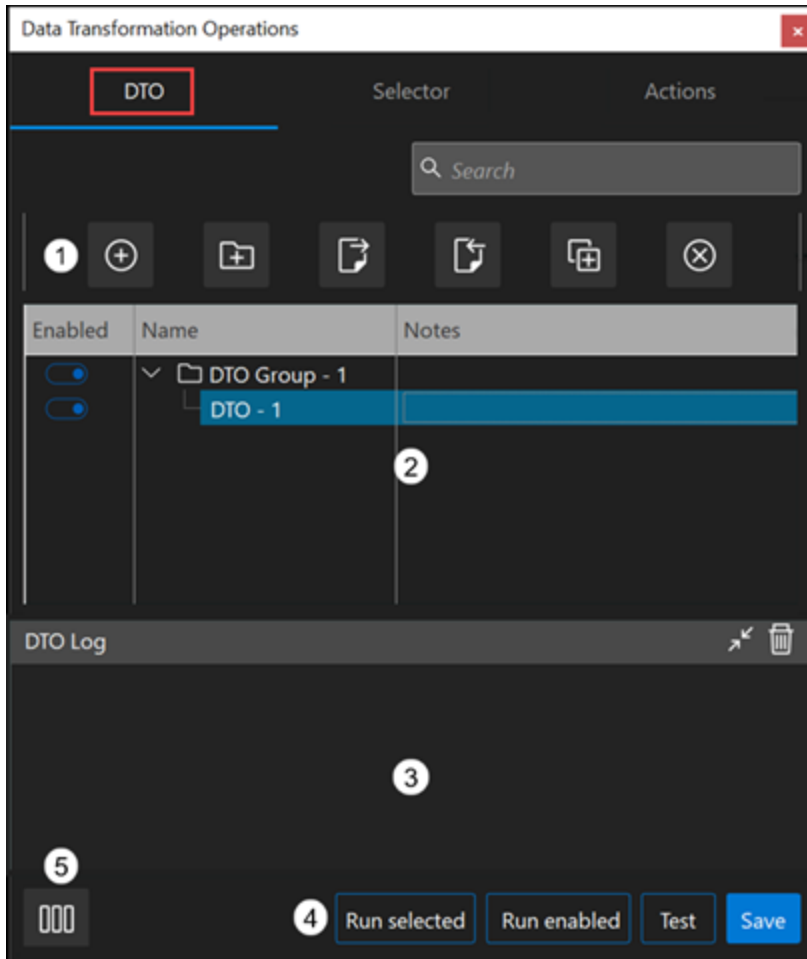

- 1 Action icons provide one-click actions for the most common DTO functions. You can add, add group, export, import, duplicate, and delete.
- 2 The list view lets you enable or disable DTOs, create DTOs, and view the list grouped by folders.
- 3 The log view shows the interaction information of DTOs when they are used. The Maximize/Minimize icon opens or closes the DTO Log panel. You can use the delete icon to clear the log.
- 4 Bottom action buttons let you run the selected DTOs or selected DTO groups, run all enabled DTOs. Test your included model objects in the Selector tab criteria.
- 5 You can use the Expand Panels icon to view all three tabs at the same time or view one tab at a time.

8.1.2 SELECTOR TAB

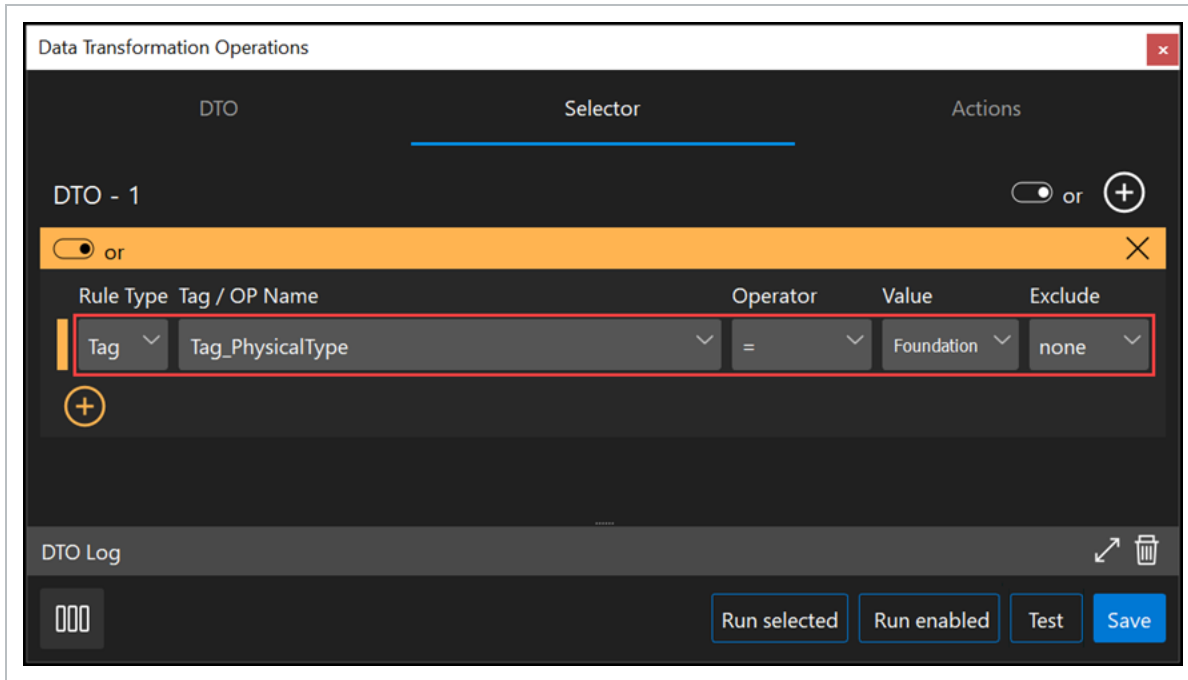

Rule Type	Select Tag or Object Property.
Tag/OP Name	Select a Tag or OP Name
Operator	Select the operator rule.
Value	Select a value from the tag or object property identified in Tag / OP Name field.
Exclude	Exclude the children or parent model objects, or you can ignore using the none value.

After you click the Test button, you can review and validate your selection criteria in the Selection Information panel.

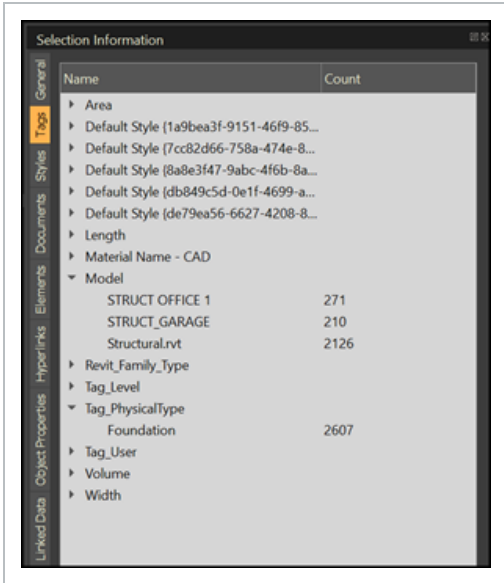

8.1.3 ACTIONS TAB

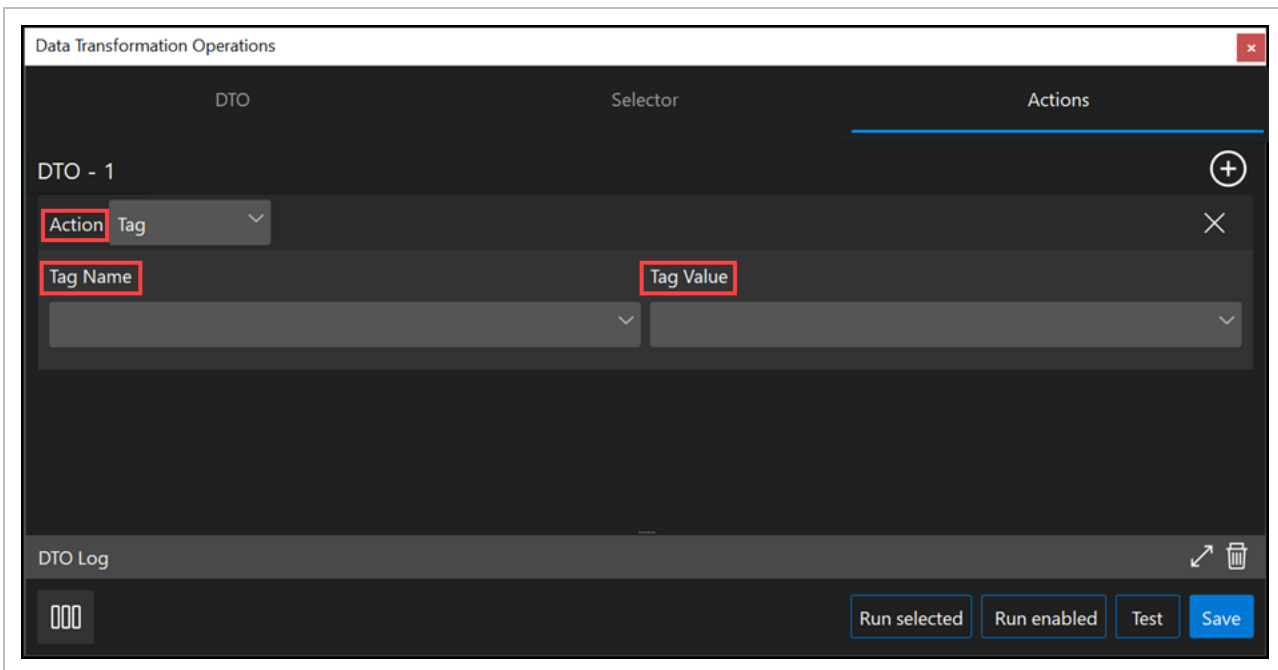

Action Select between multiple action types that include Tag, Temp Property, Calculated, Quantity, Elements, and Sequential Tags.

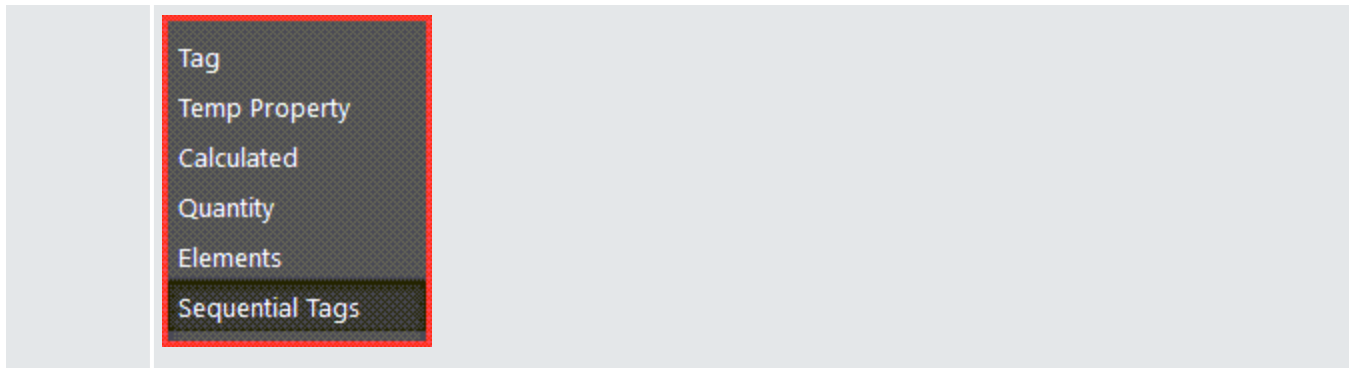

Tag Name Enter a new unique tag name or select an existing tag name.

Tag Value Enter the new value that you want to associate to the Selector tab criteria.

NOTE The available fields change depending on the action you select.

8.2 MANAGE DTOS

In the DTO tab, you can add DTOs manually. First you must create a DTO group, and then add DTOs to the group. DTOs can also be imported and exported between projects to save you time.

8.2.1 DTO TAB

ADD A DTO GROUP FOLDER

1. In the DTO tab, to Add a DTO group, click the **Add Group** icon.
2. You can add notes for the DTO group. Double-click the **Notes** section to add your notes.

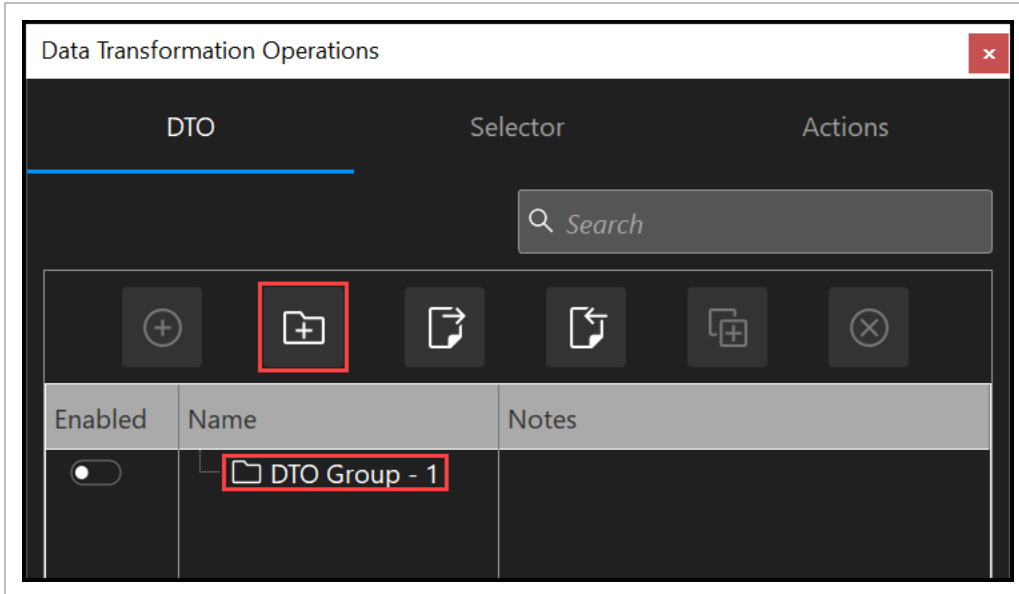

ADD A DTO

1. Select a DTO group, and then click the **Add DTO** icon. You can also right-click in the DTO group to add a DTO.
2. You can add notes for the DTO. Double-click in the **Notes** section to add your notes.

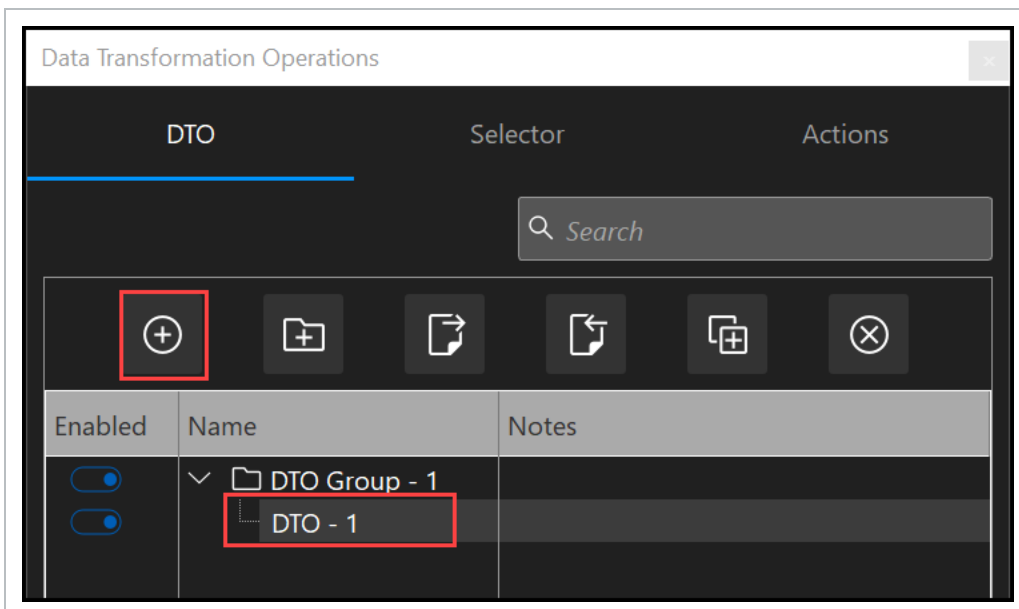

RENAME A DTO

You can rename DTO groups and DTOs to better communicate their purpose.

1. Click the DTO tab
2. Double-click the DTO Group or DTO, and then enter the new name. You can also right-click the Name column and use the menu.
3. Click **Save**.

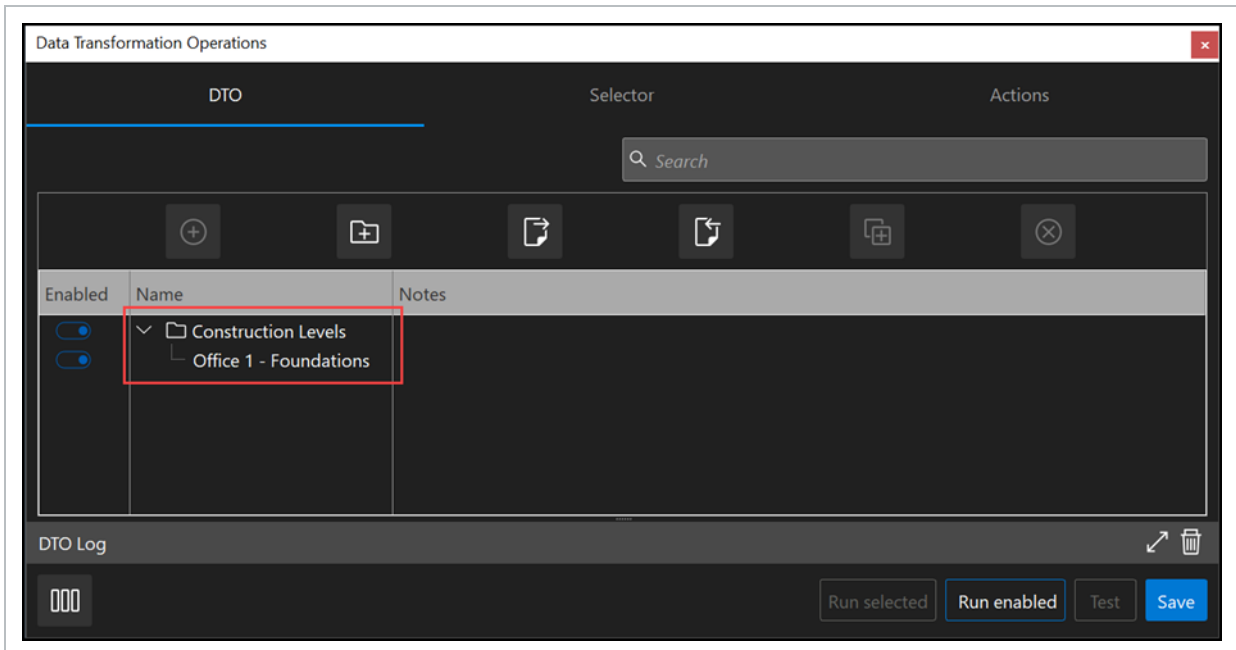

8.2.2 SELECTOR TAB

After you create a DTO, you can create rules in the Selector tab to build your own criteria to find specific model objects using their tags or object properties.

CREATE A RULE

1. In the DTO tab, click your DTO to select it.
2. Click the **Selector** tab. You can see your DTO name as a reference. By default, a blank Rule row is created.

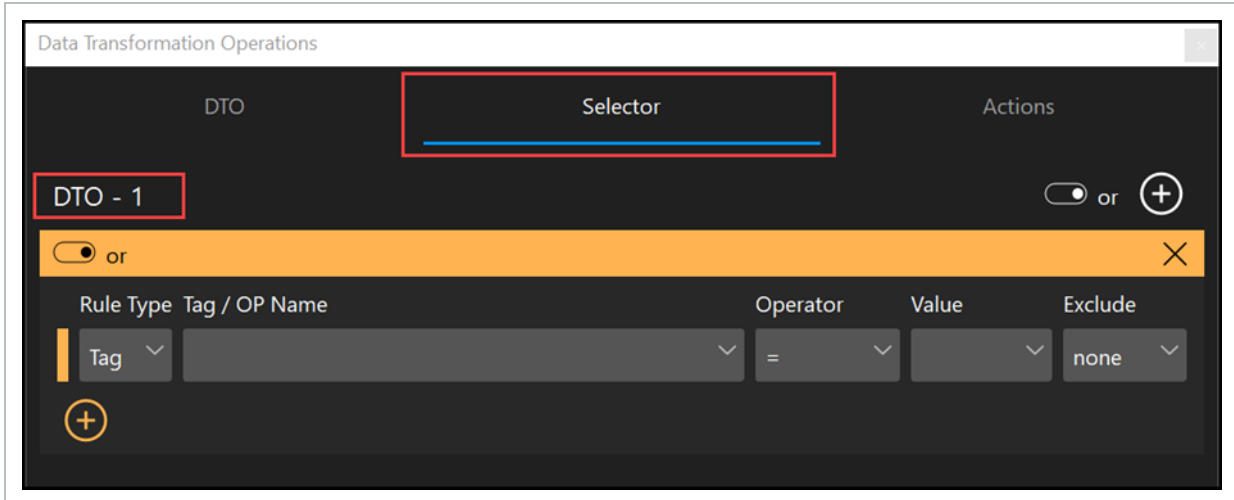

3. Fill in the rule information to identify all foundations in the model.
 - a. Rule Type
 - b. Tag / OP Name
 - c. Operation
 - d. Value
 - e. Exclude
4. Click **Test** to select all objects that meet the criteria.

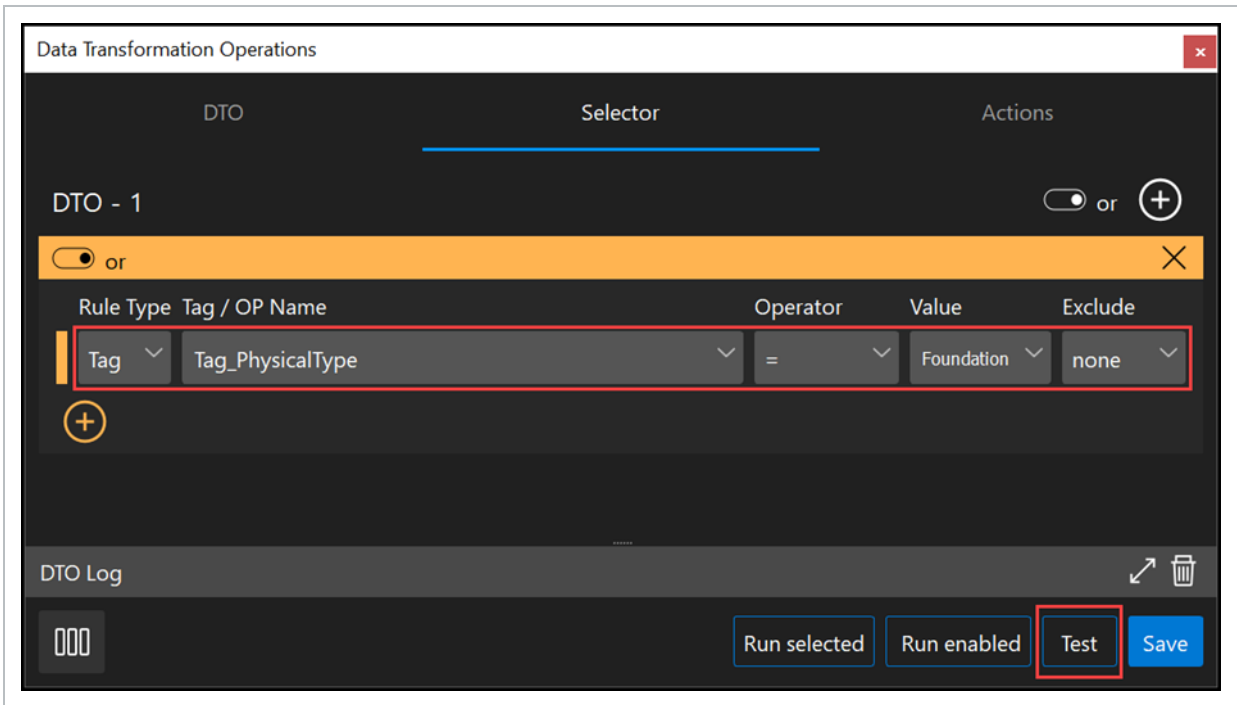

After you click Test, you can review and validate your selection criteria in the Selection Information panel.

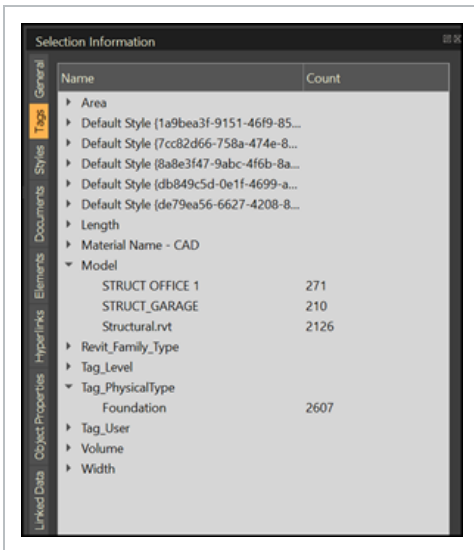

ADD ADDITIONAL RULES TO FILTER FOR OTHER METADATA

1. Click the **Add** icon below the current rule.
2. Use the **and/or** toggle to switch between the two options. The ribbon changes color depending on the option.
3. Fill in your rule criteria.
4. Click **Test** to select all objects that meet the criteria.

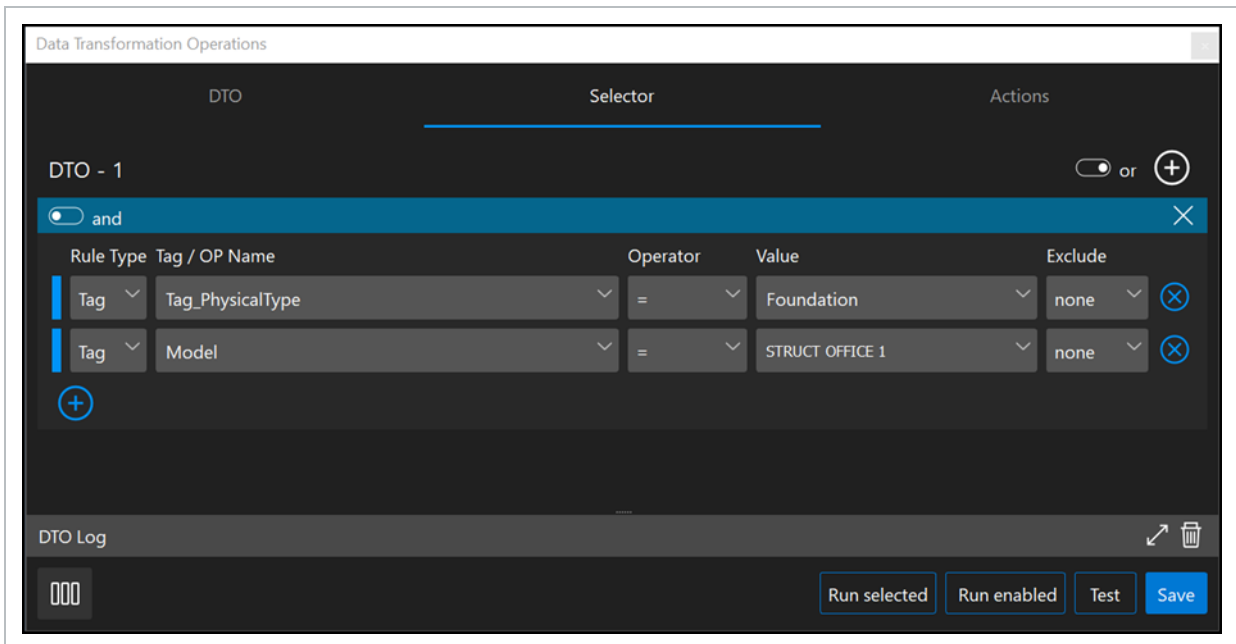

You can review and validate that you have selected the objects as expected in the Selection

Information panel.

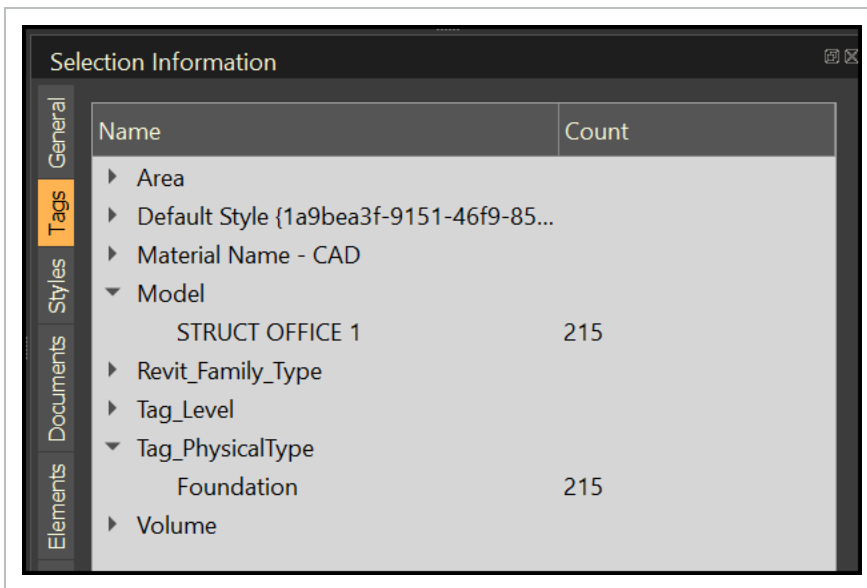

8.2.3 ACTIONS TAB

CREATE A NEW TAG

1. Click the **Actions** tab. The action window shows the DTO name and by default, creates a blank row for you to fill in.

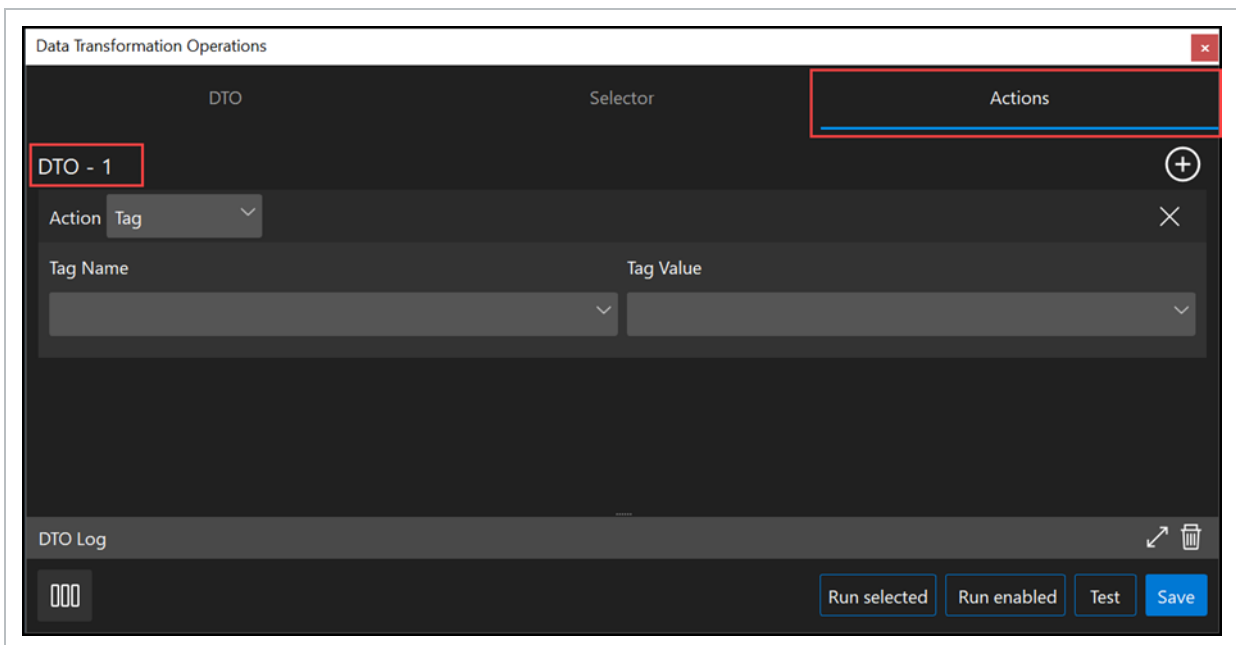

2. Fill in the criteria.
3. Enter the tag name and tag value.
4. Click **Run selected** to execute the DTO and create your tag.
 - You can expand the DTO Log panel to view information about the executed DTO.

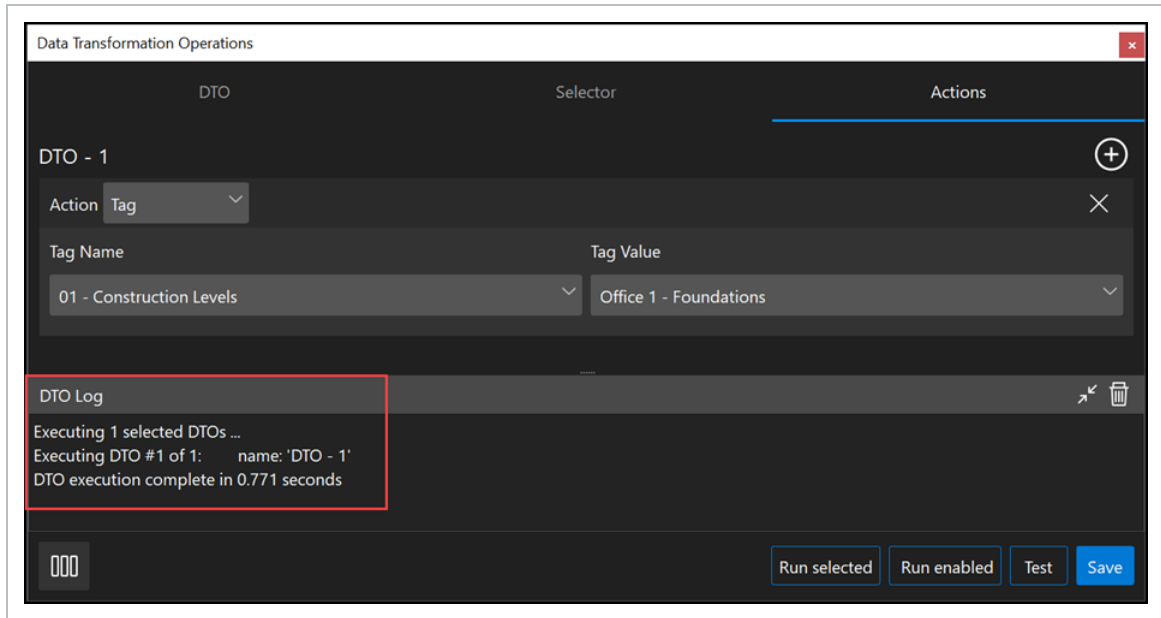

5. Click **Save**.

1.1 DTO EXAMPLES

1.2 CLEAN UP AND NORMALIZE MODEL DATA

DTOs provide flexible and repeatable processes to clean up and normalize model data. Clean up and normalizing data includes grouping the data from multiple models into a tag, grouping similar models into a single tag, converting dimensional text data into a number, and converting lengths such as inches to feet using tags and object properties.

For additional information on tags go to [Tags and Objects](#).

The following examples show you how you can use tags and object properties to clean up and normalize data.

1.2.1 GROUP SIMILAR MODELS INTO A TAG

When you have multiple models in your project that have many differences, you can create tags that combine similar models for easier and faster accessibility.

You can group models that contain Garage into a tag named Garage. Tags such as Office 1, Office 2, and Garage can be used.

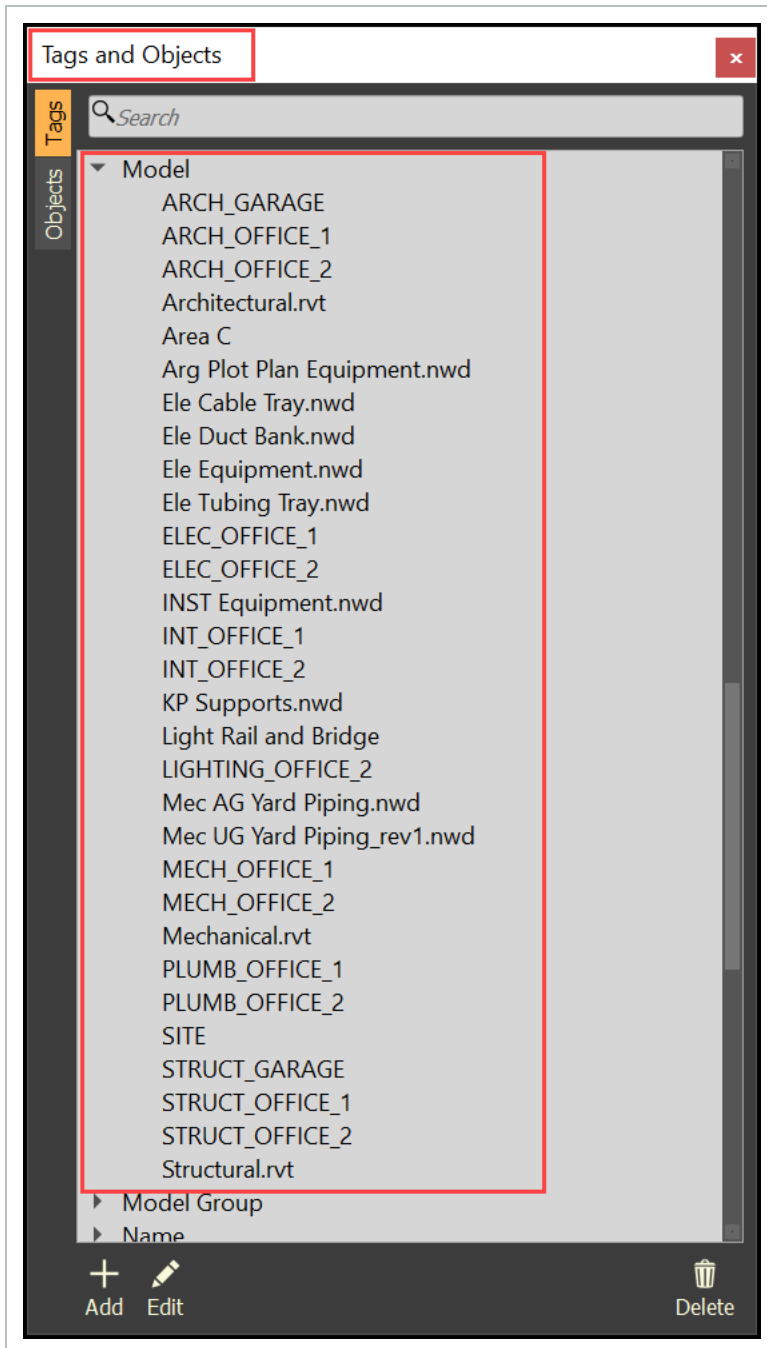

GROUP SIMILAR MODELS INTO A TAG

1. Add a DTO group and name it **Normalize**.
2. In the group, add a DTO and name it **Model Group – Garage**.

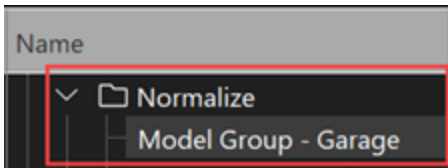

3. In the **Selector** tab create the following rule criteria:

Rule Type	Tag
Tag / OP Name	Model
Operator	contains
Value	Garage

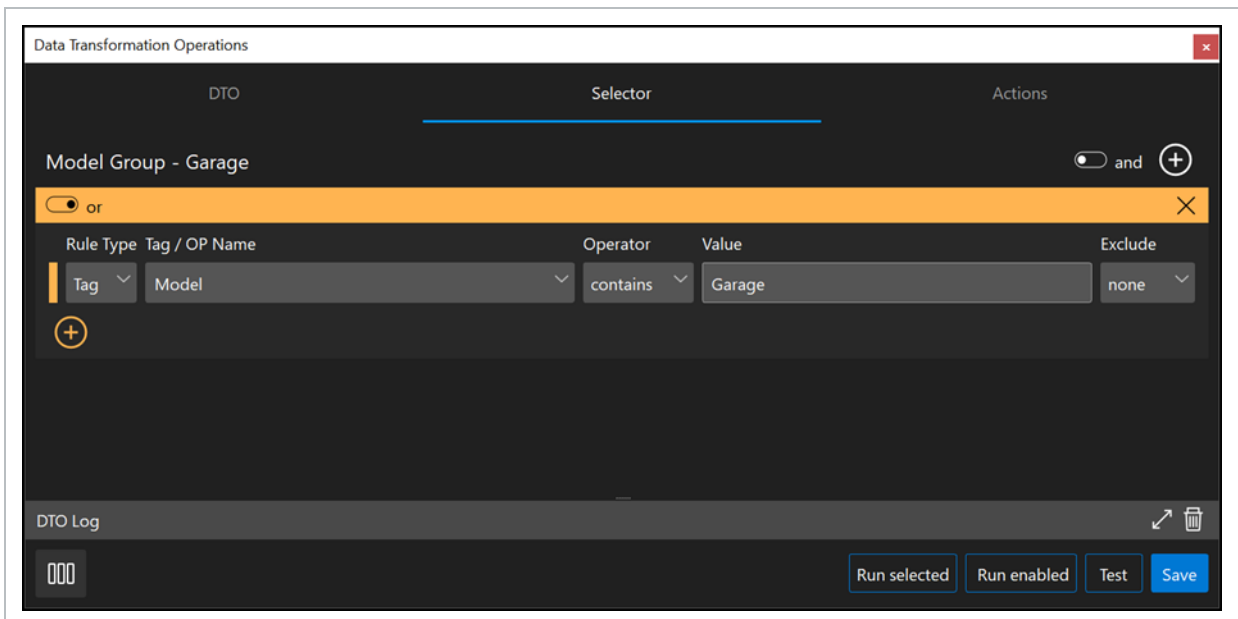

4. Click the **Test** button to review and validate your selection criteria in the Selection Information panel.

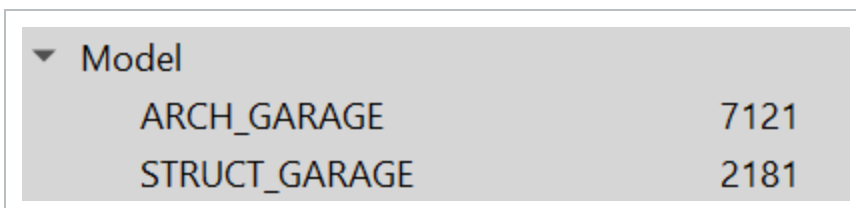

5. In the **Actions** tab use the following criteria:

Action	Tag
Tag Name	Model Group
Tag Value	Garage

- Click the **Run selected** button to execute the DTO and create the new tag according to your selection criteria. The results will include Tags associated with your selection as shown in the screenshot below.

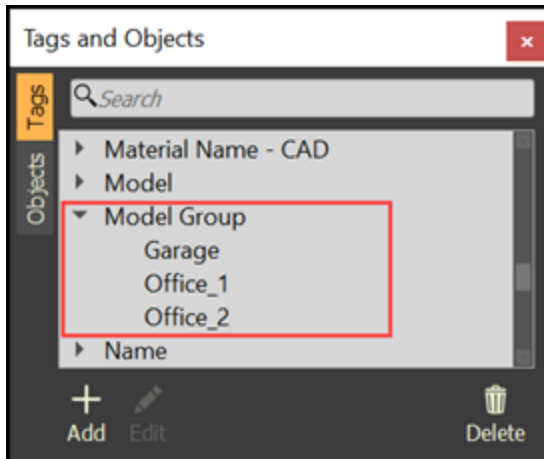

1.2.2 CONVERT DIMENSIONAL TEXT DATA INTO A NUMBER

If many of the models have dimensional data in text format, as opposed to a number format, you can normalize this into something more standard.

The model has NPD (Nominal Pipe Diameter), whereas other design applications use size. This can be normalized into something standard.

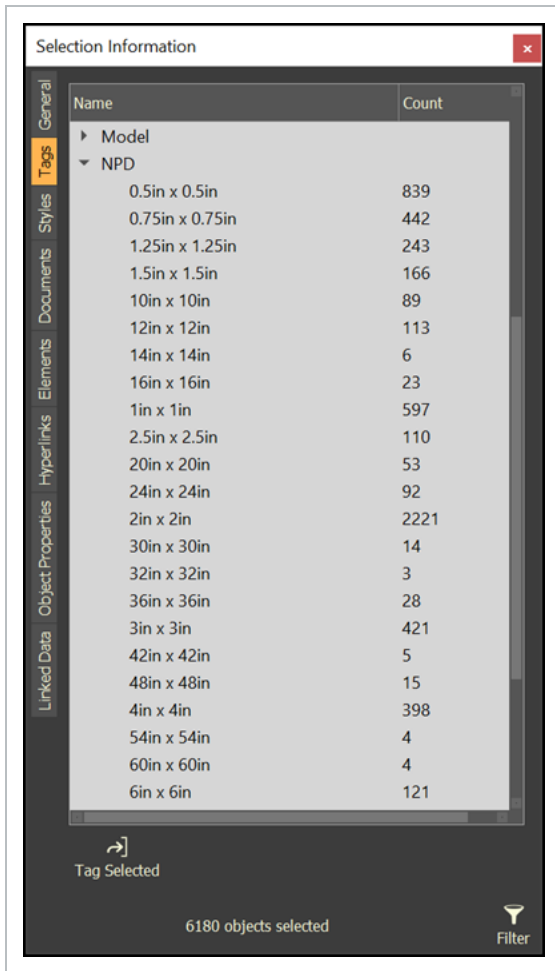

CONVERT DIMENSIONAL TEXT DATA INTO A NUMBER

1. Add a new DTO group in a new group or an existing group such as Normalize, and then name it **Piping**.
2. Add a new DTO in the group named **NPD to Size_Pipe**. You can add a note in the Notes column to communicate the purpose of the DTO.
3. In the **Selector** tab use the following criteria:

Rule Type	Tag
Tag / OP Name	NPD
Operator	not null

- Click the **Add row** icon below the row to add another row. Add an additional rule that will filter for Piping:

Rule Type	Tag
Tag / OP Name	NPD
Operator	=
Value	Piping

- Click the **and/or** toggle above the first rule on the top left to select **and**. Selecting **and** means that both rules must apply to the model object data.

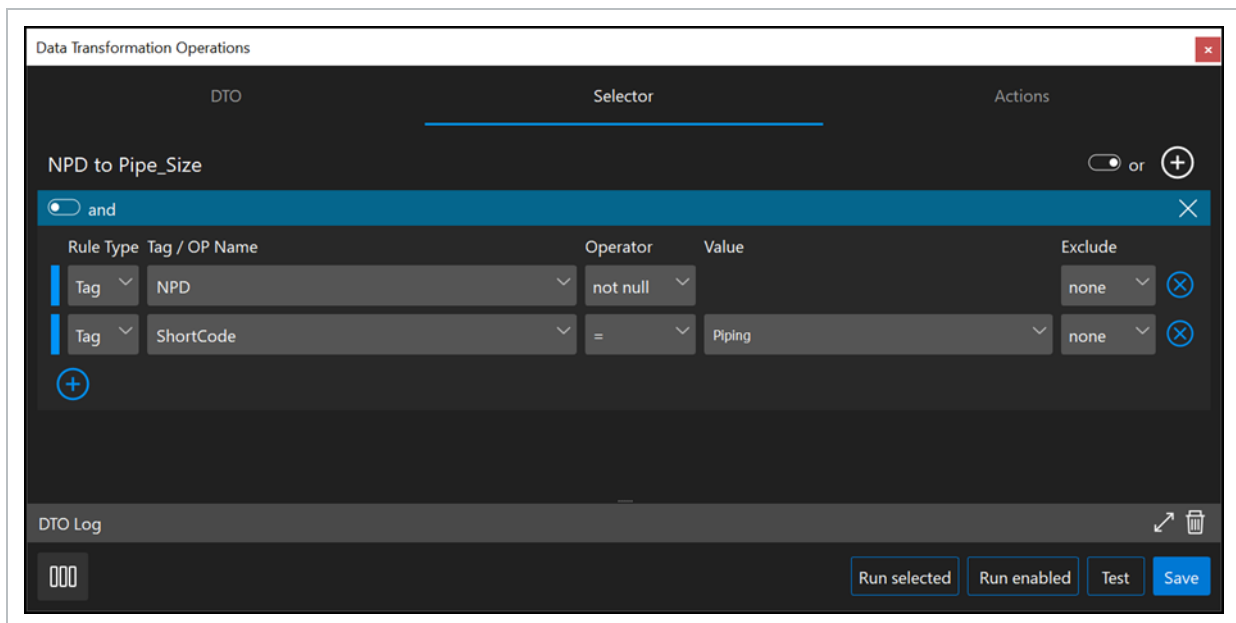

- You can click the **Test** button to review and validate your selection criteria in the Selection Information panel.

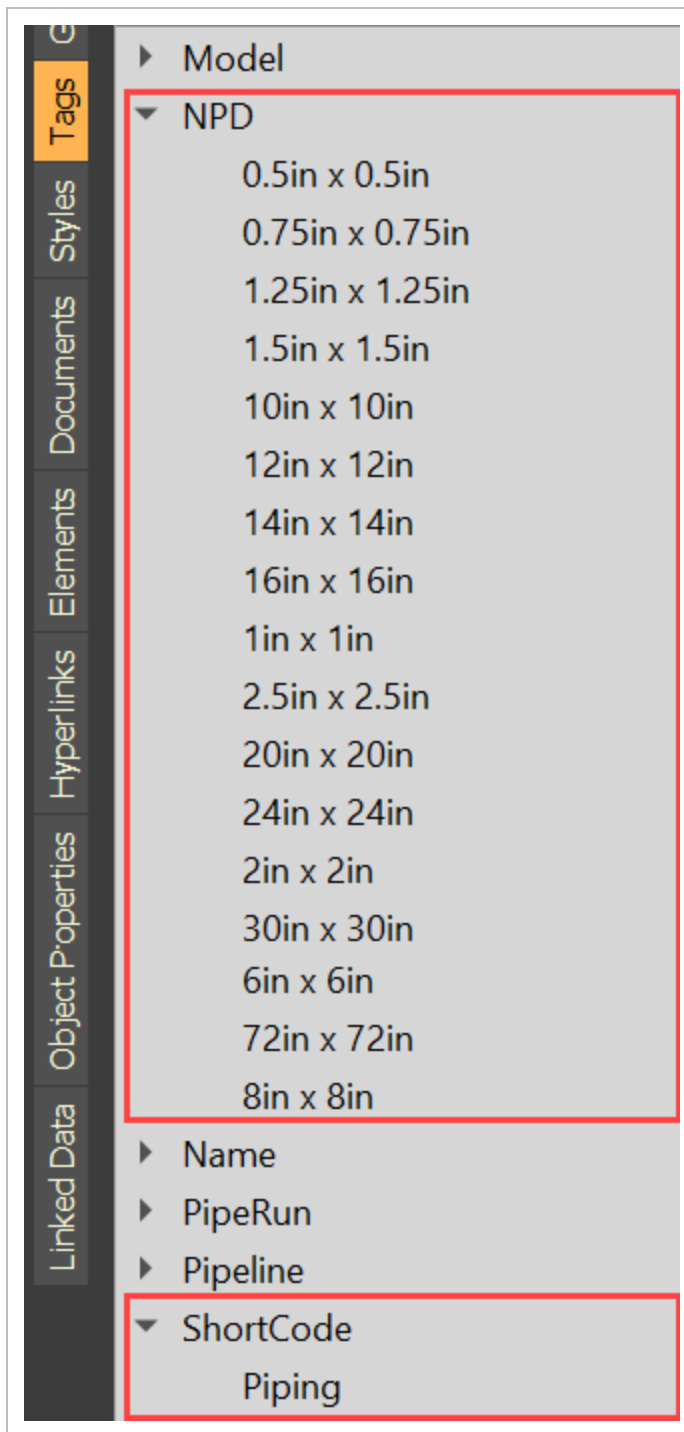

6. In the **Actions** tab select **Calculated** for Action.

7. Click the **Add row** icon next to Action to add a new function, and then use the following criteria:

Function	number()
Tag	NPD
Position	0

NOTE The *number()* function will convert the text data to number data.

8. Add another function, and then use the following criteria:

Function	tag()
Tag	IN8_Size_Pipe

NOTE IN8_Size_Pipe is a custom tag name. You can create and give your tag a specific name that will help you organize your data.

- In the DTO Log window, the Tag Name and Value shows the expected results after the DTO is executed.

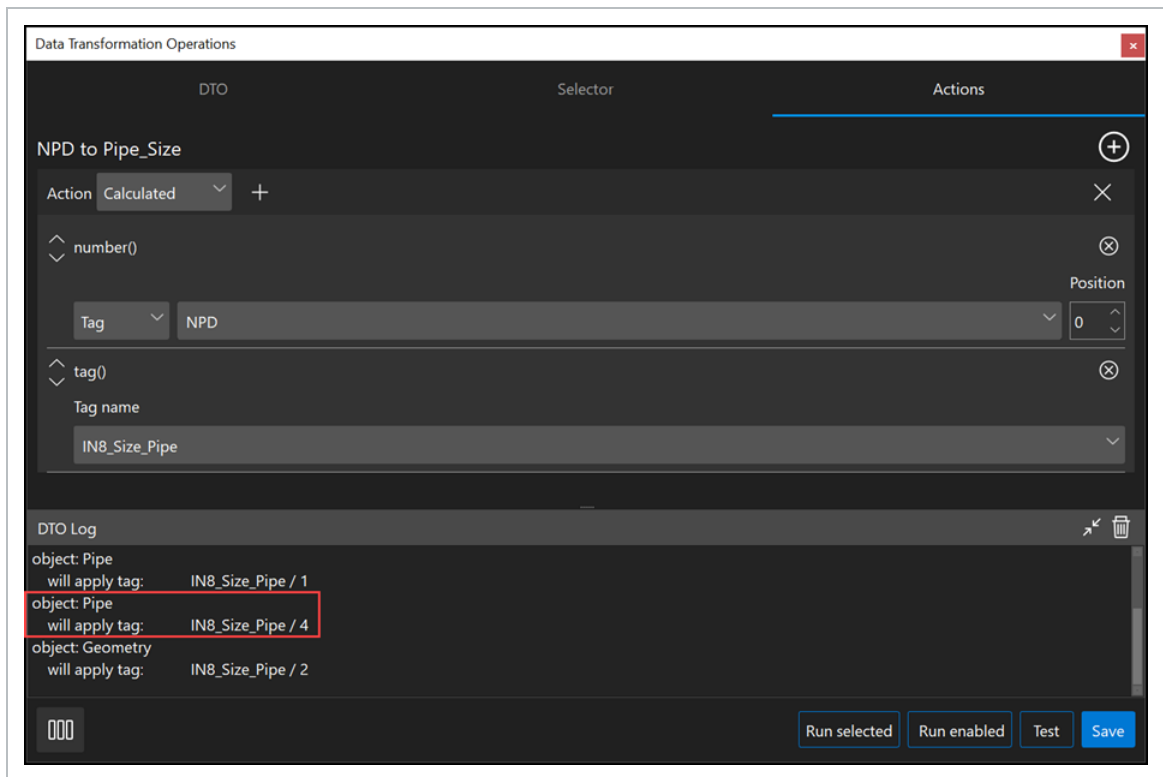

9. Click the **Run selected** button to execute the DTO and create the new tag according to your selection criteria.

1.2.3 CONVERT INCHES TO FEET

You can use DTOs to convert units. If you have models that have piping length in inches, and you need to convert the length to feet for take-off, you can create a DTO to convert the units.

CONVERT TEXT FORMAT TO NUMBER FORMAT

1. Add a new DTO to convert the length of piping from text format to number format. Name the new DTO **Pipe Length (in)**.
2. In the **Selector** tab use the following criteria:

Rule Type	Tag or Object Property
Tag / OP Name	Length
Operator	not null

3. Use the **and/or** group toggle at the top right to select **and**.

4. Click the **Add group** icon at the top right and include the following group criteria:

Rule Type	Tag
Tag / OP Name	Model
Operator	=
Value	Mec AG Yard Piping.nwd

5. Click the **Add row** icon on the bottom left, and then use the following criteria:

Rule Type	Tag
Tag / OP Name	Model
Operator	=
Value	Mec UG Yard Piping_rev1.nwd

6. Use the **and/or** row toggle on the top left above the group rows to select **or**.

- The criteria selected will find all objects with a Length value. The **and** group toggle at the top right means that both listed model tag groups will be included.

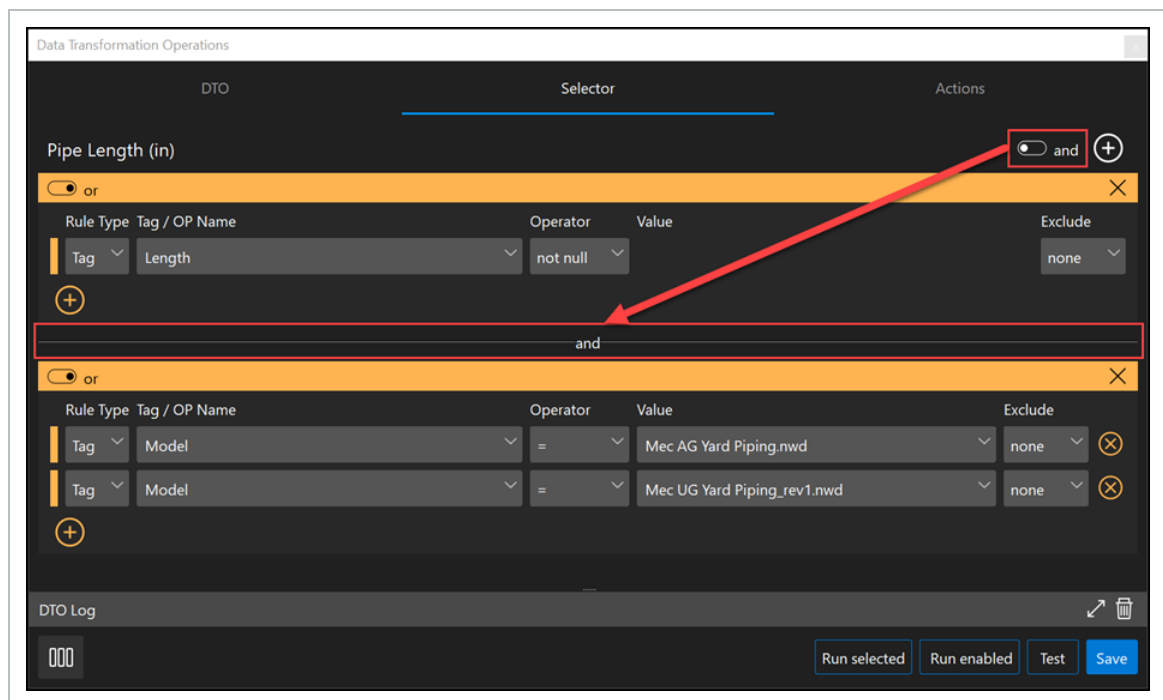

- In the **Actions** tab select **Calculated** for Action.
- Click the **Add** icon next to Action to add a function, and then use the following criteria:

Function	number()
Tag	Length

- Add another function with the following criteria:

Function	tag()
Tag	Length_Pipe (in)

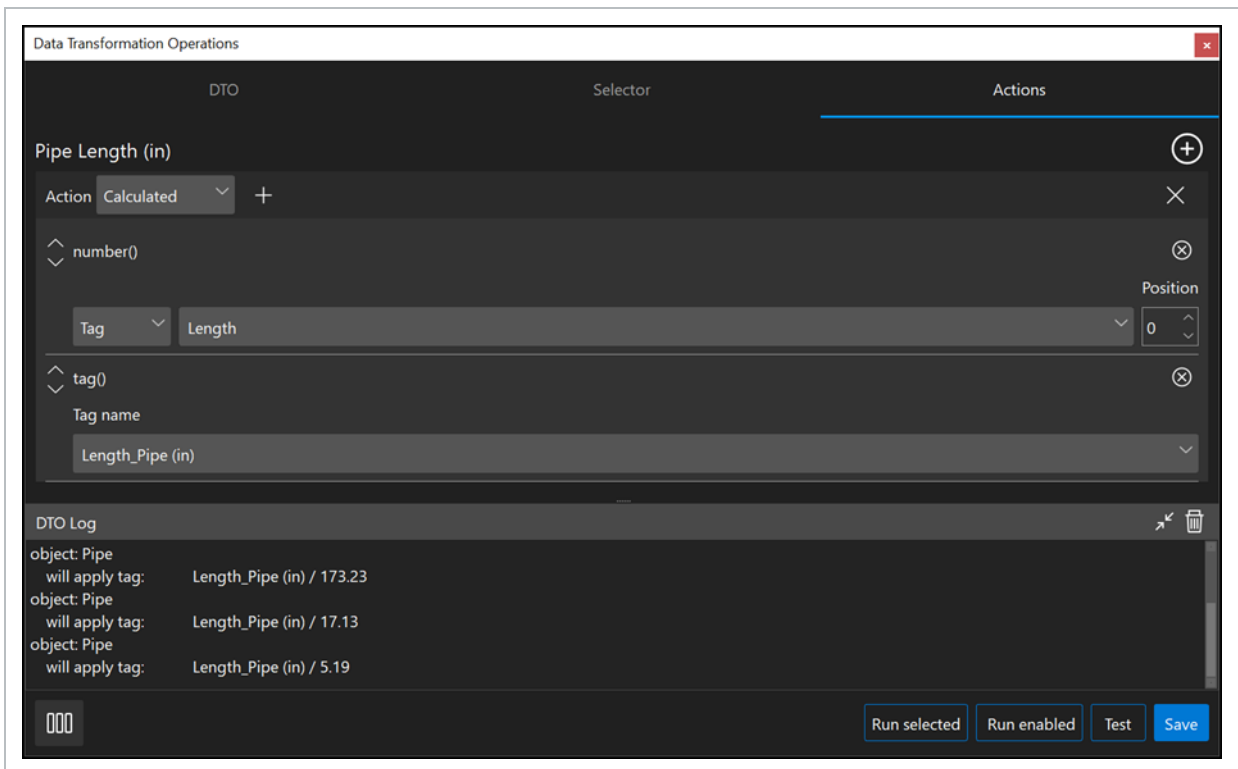

- Click the **Run selected** button to execute the DTO and create the new tag according to your selection criteria.

CONVERT PIPING LENGTH FROM INCHES TO FEET

1. Add a new DTO, and then name it **Pipe Length (ft)**.
2. In the **Selector** tab create the following criteria:

Rule Type	Tag
Tag / OP Name	Length_Pipe (in)
Operator	not null

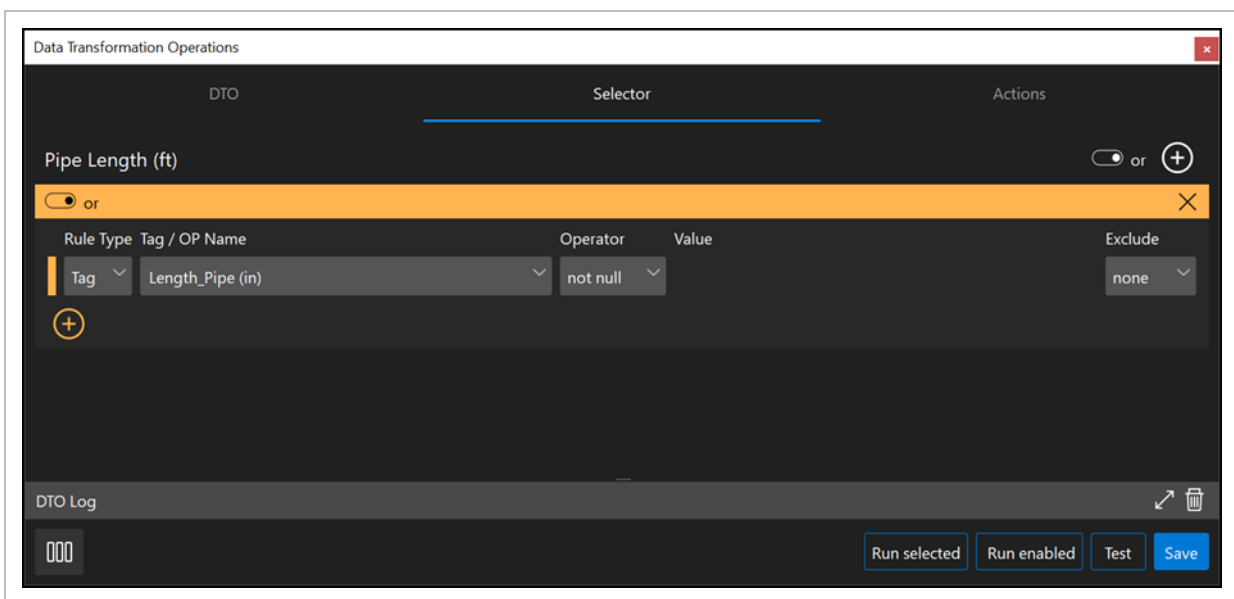

3. In the **Actions** tab select **Calculated** for Action.
4. Click the **Add** icon next to Action to add a function, and then use the following criteria:

Function	math()
Tag	Length_Pipe (in)
Operator	/
Constant	12

NOTE The *math()* function can be used with Tags, Object Properties, and Constants. Constant will equal type in a number as opposed to using a tag.

5. Add another function with the following criteria:

Function	tag()
Tag	Length_Pipe (ft)

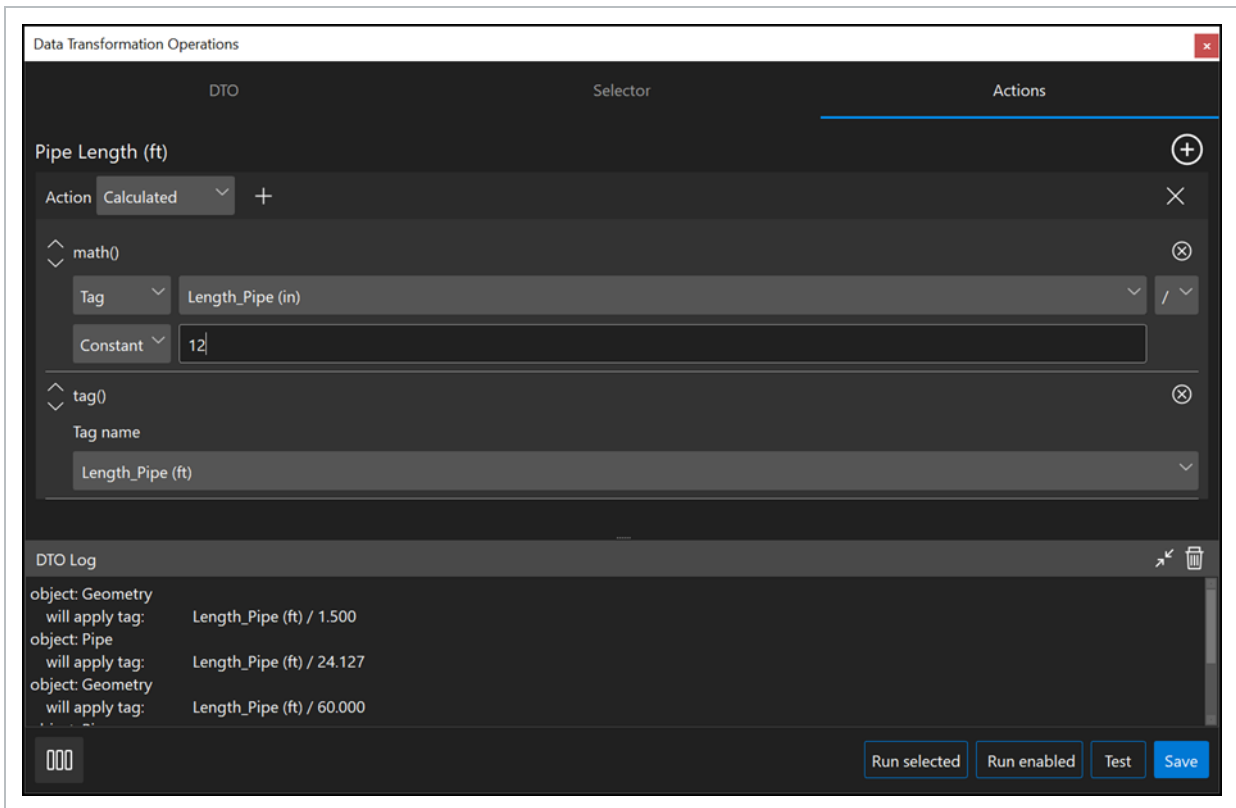

6. Click the **Run selected** button to execute the DTO and create the new tag according to your selection criteria.

1.3 IDENTIFY AND ADD ADDITIONAL MODEL DATA

DTOs provide flexible and repeatable processes to add additional model data. The following are examples to show you processes to identify specific model data and add model data using DTOs.

1.3.1 IDENTIFY MODEL DATA

You can differentiate between above ground large bore piping (AG/LB), above ground small bore piping (AG/SB), underground large bore piping (UG/LB) and underground small bore piping (UG/SB).

You can add a DTO to find all large bore piping according to your standards (>2.5"). Also, create a new tag named AG LB to find all above ground piping.

IDENTIFY AND USE AG/LB PIPING

Add a new DTO, and then name it **Pipe – AG LB**.

In the **Selector** tab create the following criteria:

Rule Type	Tag
Tag / OP Name	Model
Operator	=
Value	Mec AG Yard Piping

Use the **and/or** row toggle on the top left to **and**.

Click the **Add row** icon below the row, and then use the following rule criteria:

Rule Type	Tag
Tag / OP Name	IN8_Size_Piping
Operator	>
Value	2

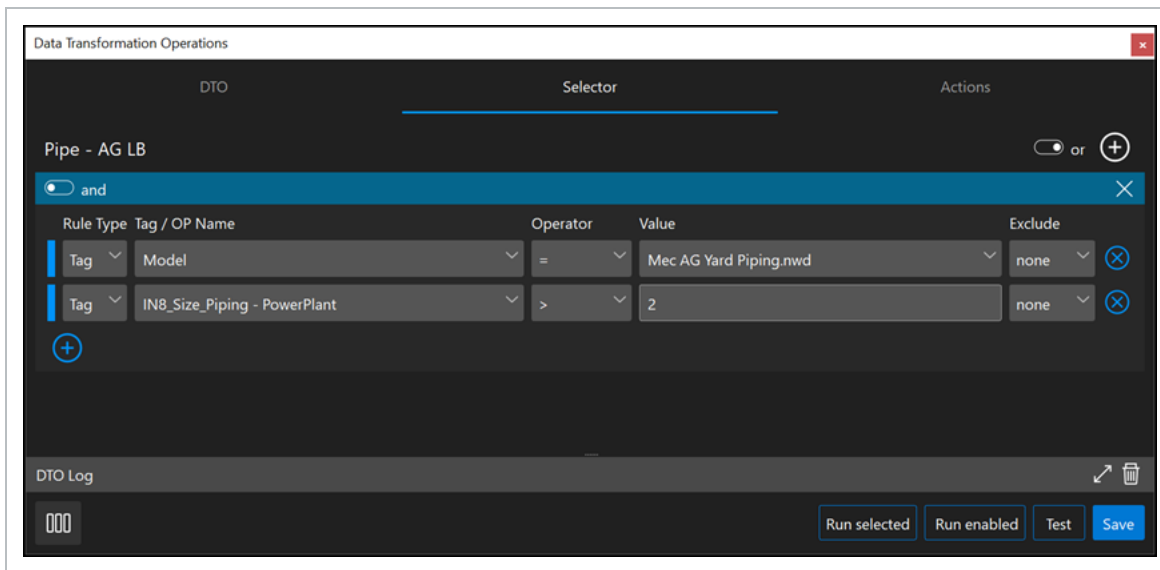

In the **Actions** tab use the following criteria:

Action	Tag
Tag Name	IN8_PipeAG/UG_LB/SB - PowerPlant
Tag Value	AG LB

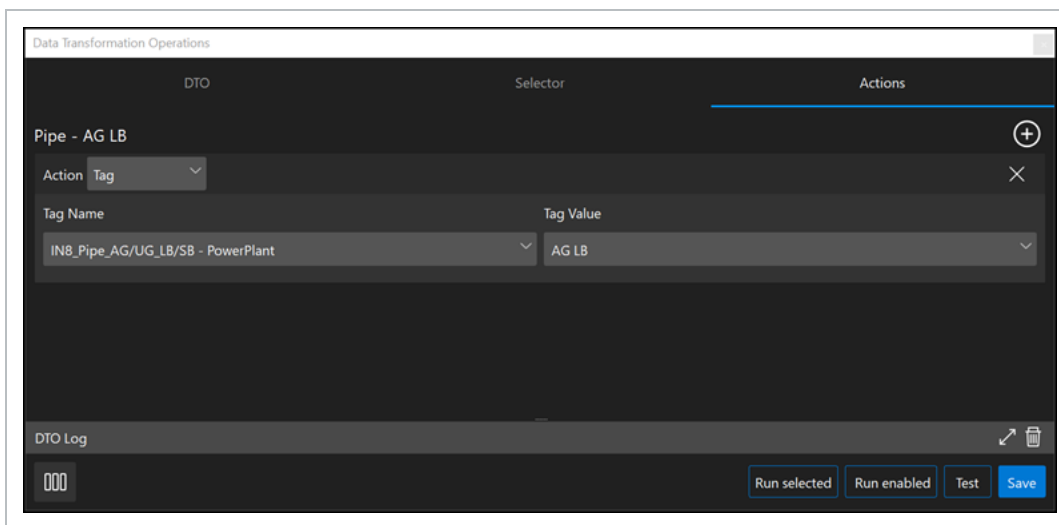

Click on the **Run selected** button to execute the DTO and create the new tag according to your selection criteria.

IDENTIFY AND USE AG/SB

1. Add a new DTO to find all small bore piping according to your standards (<2"). Also, create a new tag named AG SB to find all above ground piping.
2. Duplicate the previous DTO, and then rename the new DTO **Pipe – AG SB**.
3. In the **Selector** tab update the following criteria:

Operator	<
Value	2.5

4. Leave the rest of the criteria the same.

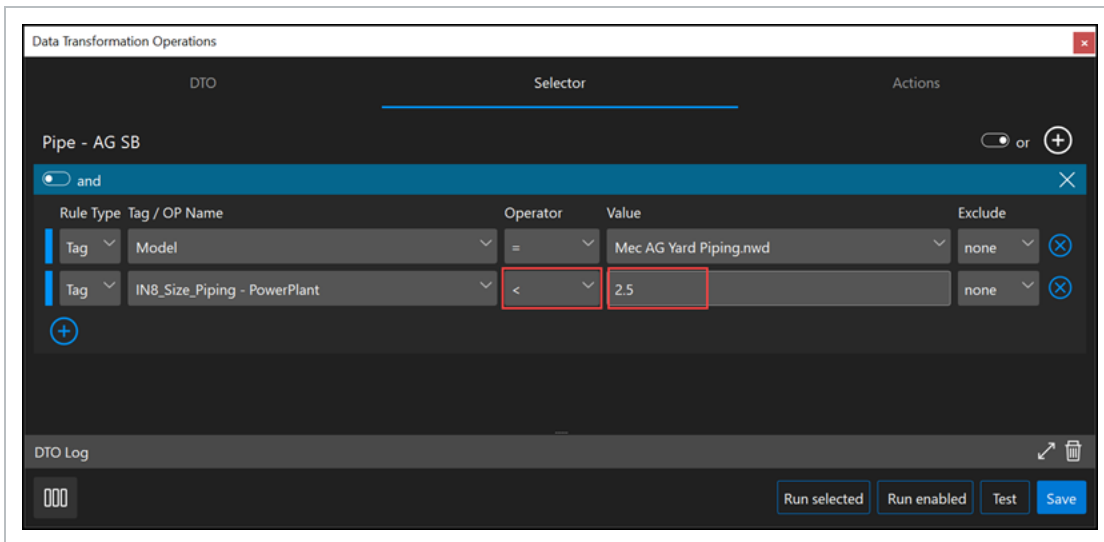

5. In the **Actions** tab use the following criteria:

Action	Tag
Tag Name	Model Group
Tag Value	AG-SB

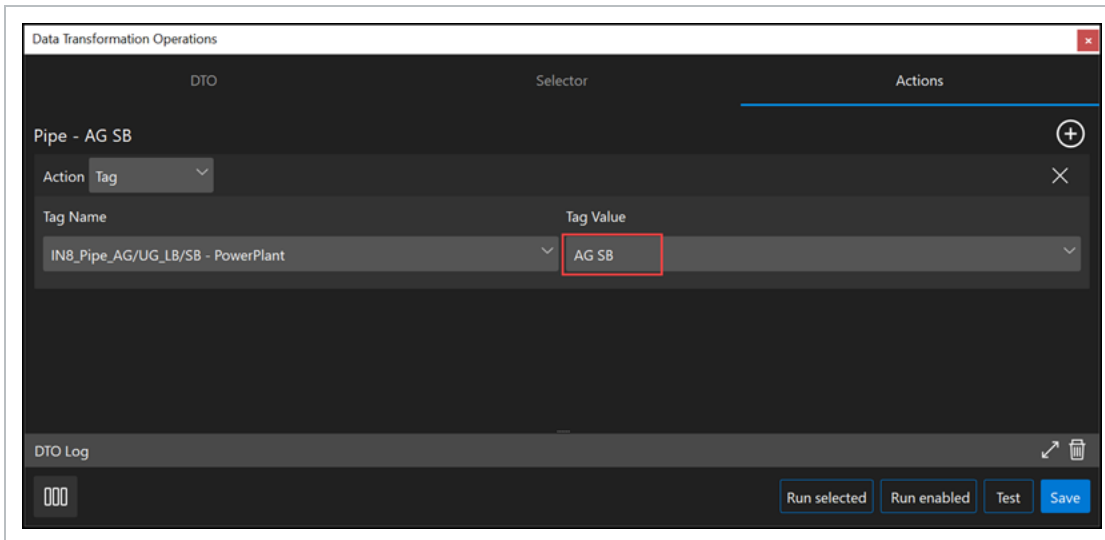

6. Click on the **Run selected** button to execute the DTO, and then create the new tag according to your selection criteria.

If your model includes the steel members length but does not have the weight, you can calculate the length into weight for take-off.

ADD WEIGHT TO STEEL MEMBERS USING LENGTH

1. Add a new DTO, and then name it **W Shapes in LBs**.
2. In the **Selector** tab create the following new rule criteria:

Rule Type	Tag
Tag / OP Name	Revit_Family_Type
Operator	contains
Value	W Shape

3. Use the **and/or** row toggle on the top left to select **and**.
4. Click the **Add row** icon on the bottom left, and then use the following criteria:

Rule Type	Tag
Tag / OP Name	Length
Operator	not null
Value	W Shape

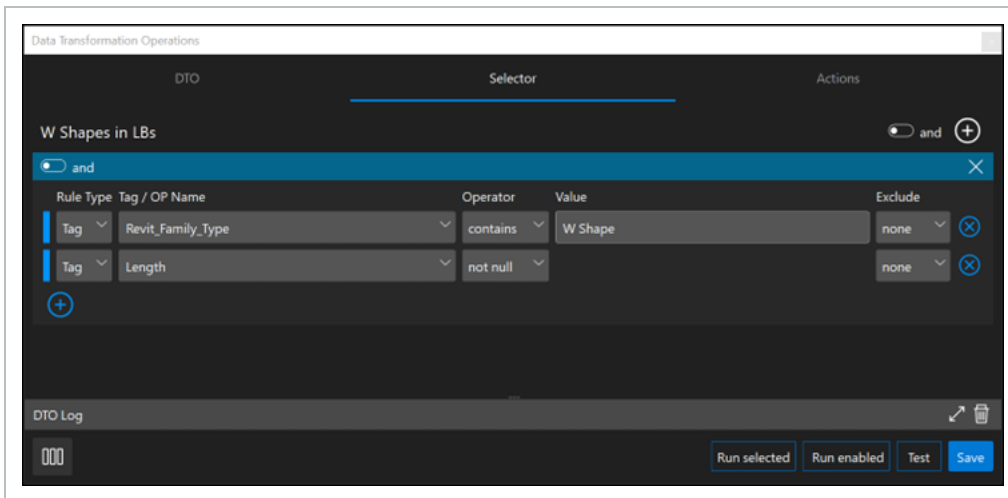

1. In the **Actions** tab select **Calculated** for Action.
2. Click the **Add** icon next to Action to add a function with the following criteria, assuming 90 lbs. per foot:

Function	math()
Constant	90
Operator	*
Tag	Length

NOTE

The *math()* function can be used with Tags, Object Properties, and Constants. Constant will equal *type* in a number as opposed to using a tag.

3. Add another function with the following criteria:

Add another function with the following criteria:

Function	Tag()
Tag name	Calculated Nominal Weight (lbs)

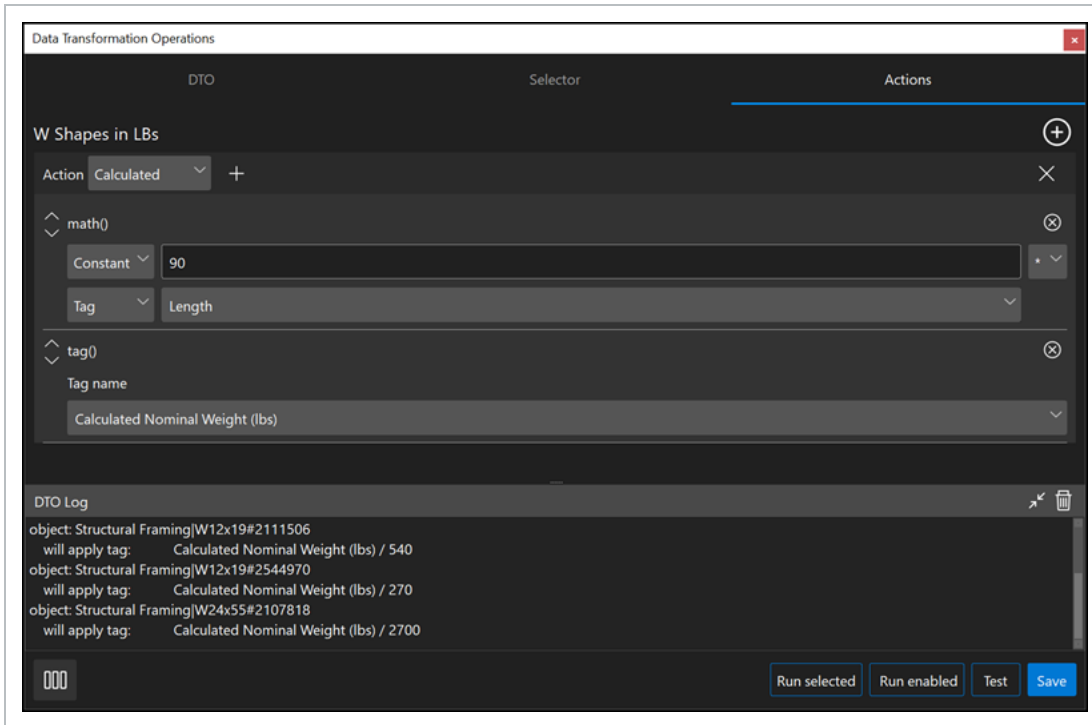

4. Click the **Run selected** button to execute the DTO and create the new tag according to your selection criteria.

Now that the previous DTO calculates the length of your steel members into weight in pounds, you need to calculate the weight into tons for take-off.

CONVERT WEIGHT FROM POUNDS TO TONS

1. Duplicate the previous DTO, and then name the new DTO **Weight (ton)**.
2. In the **Selector** tab create the following new rule criteria:

Rule Type	Tag
Tag / OP Name	Calculated Nominal Weight (lbs)
Operator	not null

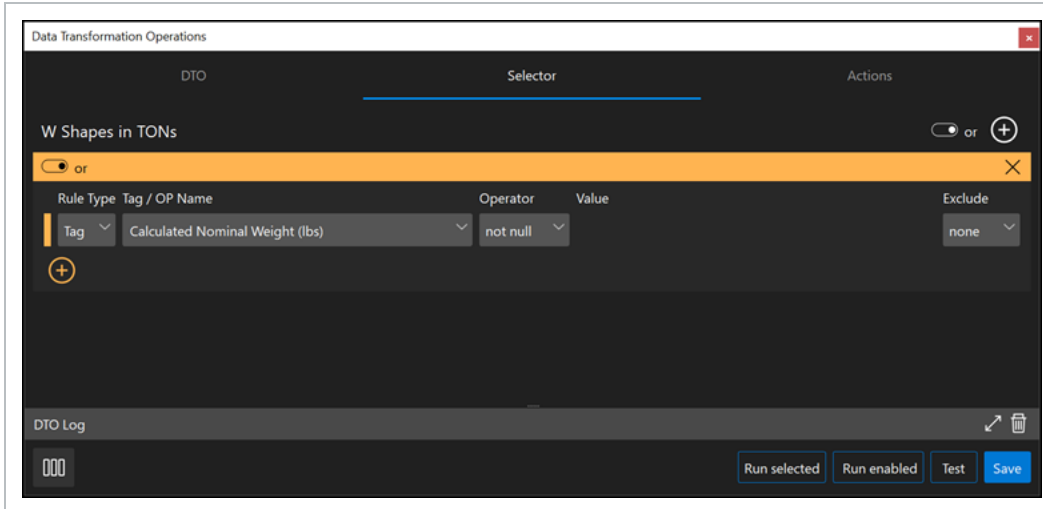

3. In the **Actions** tab select **Calculated** for Action.
4. Click the **Add** icon next to Action to add a function with the following criteria:

Function	math()
Tag	Calculated Nominal Weight (lbs)
Operator	/
Constant	2000

5. Add another function with the following criteria:

Function	Tag()
Tag name	Weight (ton)

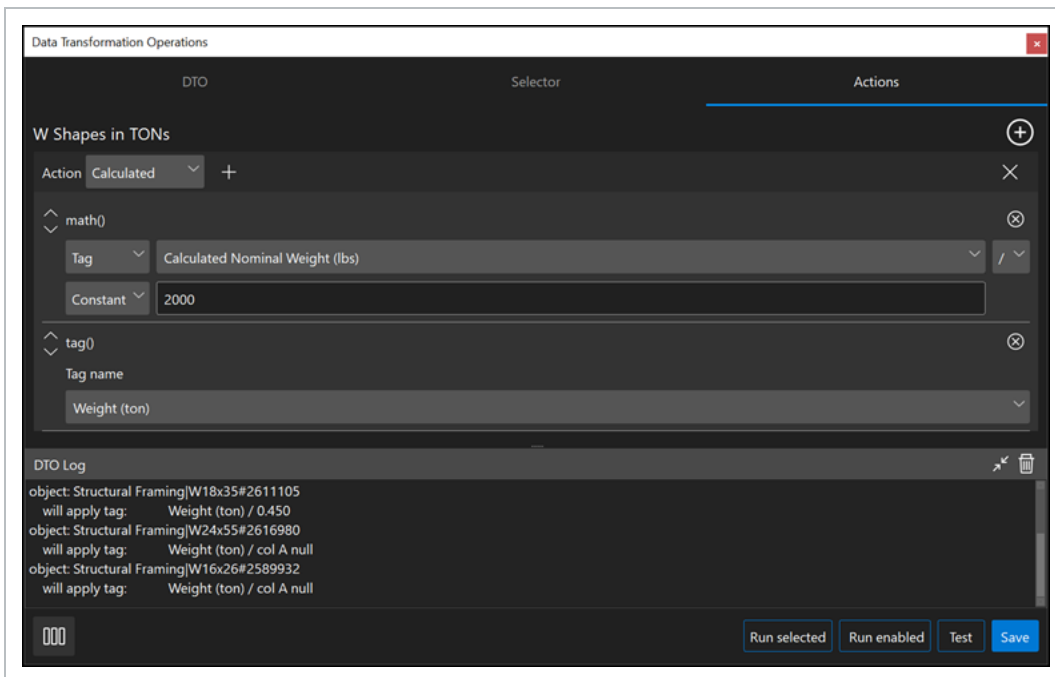

6. Click the **Run selected** button to execute the DTO and create the new tag according to your selection criteria.

1.4 CONCATENATE MODEL DATA

Data Transformation Operations (DTOs) provide flexible and repeatable processes to concatenate model data. In the following examples you will see how you can concatenate model data using DTOs.

Data structured in models that you receive do not always provide data in a way that you can use. You need to concatenate data to create unique tags.

MAKE UNIQUE TAG VALUES FOR MULTIPLE OBJECTS

1. Add a new DTO, and then name it **Spool Number**.
2. In the **Selector** tab use the following criteria:

Rule Type	Tag
Tag / OP Name	Pipeline
Operator	contains
Value	RWS

- Use the **and/or** row toggle on the top left to select **and**.
- Click on the **Add row** icon on the bottom left to create a new row, and then use the following criteria:

Rule Type	Tag
Tag / OP Name	00-CWA
Operator	not null

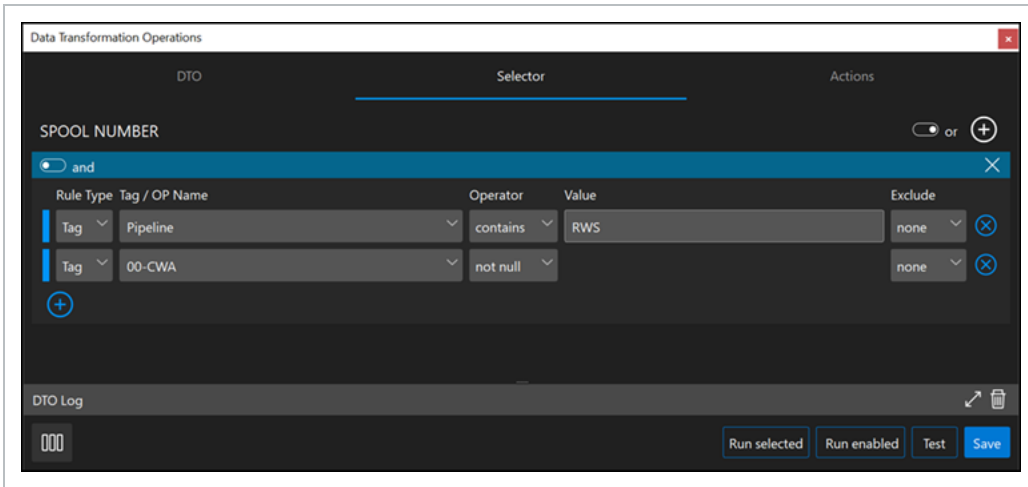

- In the **Actions** tab select **Calculated** for Action.
- Click the **Add** icon next to Action to add a function, and then use the following criteria:

Function	text()
Tag Name	00-CWA

- Add additional rows, and then create a series of functions using dash as a constant as shown:

Function	text()
Tag Name	-

Function	text()
-----------------	--------

Tag Name IN8_System - PowerPlant

Function text()

Tag Name -

Function text()

Tag Name IN8_LineNumber - PowerPlant

Function text()

Tag Name -

Function text()

Tag Name -01

Function tag()

Tag Name IN8_SpoolNumber

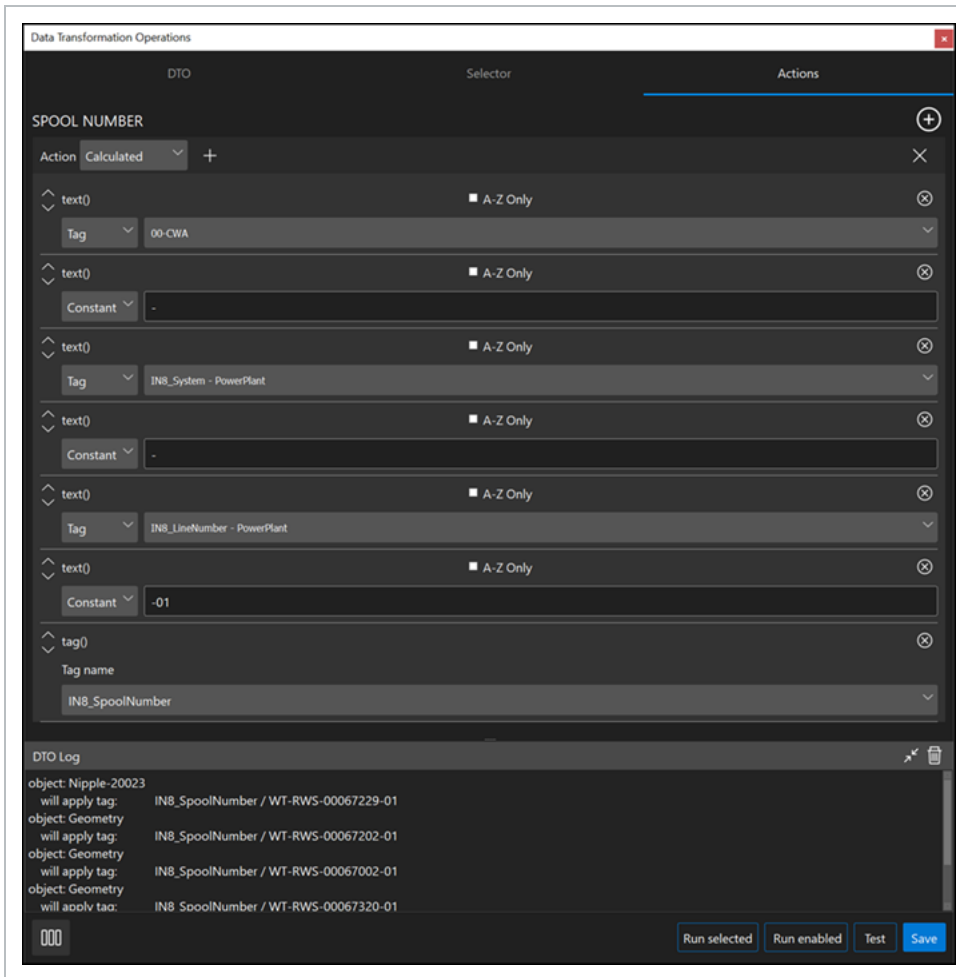

- Click on the **Run selected** button to execute the DTO and create the new tag according to your selection criteria.

1.5 PARSE MODEL DATA

Data Transformation Operations (DTOs) provide flexible and repeatable processes to parse model data. An example is if your project systems are concatenated into other metadata, you can parse it to its own tag. In the following example you will see how you can parse model data using DTOs.

If your project systems are concatenated into other metadata, you should parse it to its own tag to easily access the model by systems.

PARSE SYSTEM INFORMATION

1. Add a DTO, and then name it **Systems – Piping**.
2. In the **Selector** tab use the following criteria:

Rule Type	Tag
Tag / OP Name	Pipeline
Operator	not null

3. Add a DTO, and then name it **Systems – Piping**.
4. In the **Selector** tab use the following criteria:
5. Use the **and/or** group toggle at the top right to select **and**.
6. Click the **Add group** icon at the top right, and then include the following group criteria:

Rule Type	Tag
Tag / OP Name	Model
Operator	=
Value	Mec AG Yard Piping.nwd

7. Click the **Add row** icon below the row to add another row, and then use the following criteria:

Rule Type	Tag
Tag / OP Name	Model
Operator	=
Value	Mec UG Yard Piping_rev1.nwd

8. Use the **and/or** row toggle above the grouped rows on the top left and select **or**.

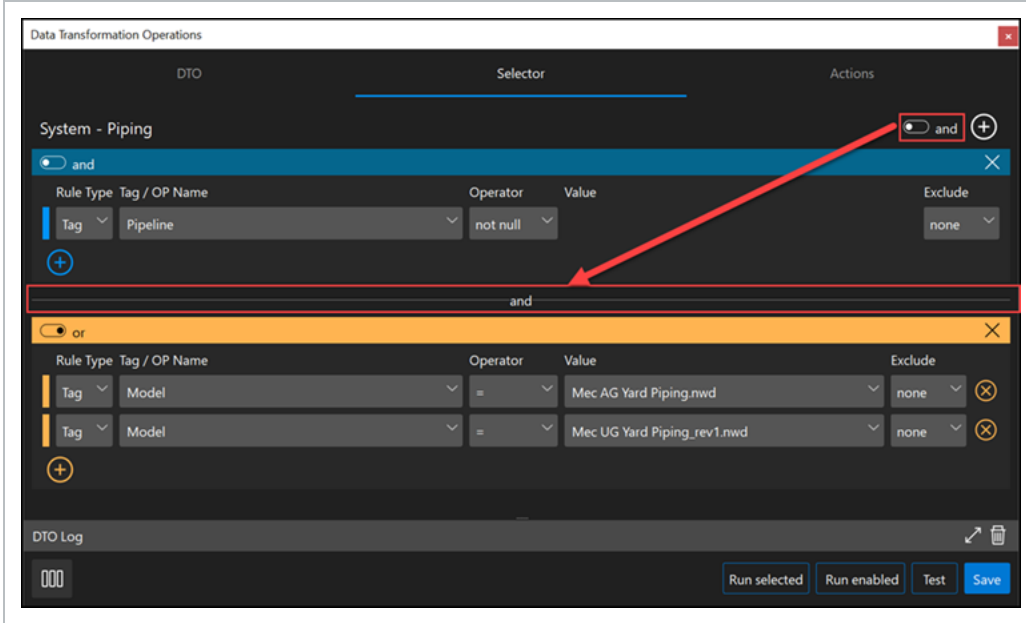

The selected criteria will find all objects with a Pipeline value. When you use the **and** group toggle, it will select the objects from the listed model tag values.

9. Click the **Test** button to review and validate your selection criteria in the Selection Information panel. Results should include AQ-00074001 and CWR-00064101.
10. In the **Actions** tab select **Calculated** for Action.
11. Click the **Add** icon next to Action to add a new function, and then use the following criteria:

Function	substr()
Tag	Pipeline
Index of	-
Offset	1
Length	-3

NOTE The *substr()* function lets you parse out your selected characters within a string of characters.

NOTE The *Index of* field can be blank, or you can enter any character from where you want to start indexing. This example starts at the dash value in this string of characters for AQ-00074001.

12. Add another function with the following criteria:

Function	tag()
Tag	IN8_System

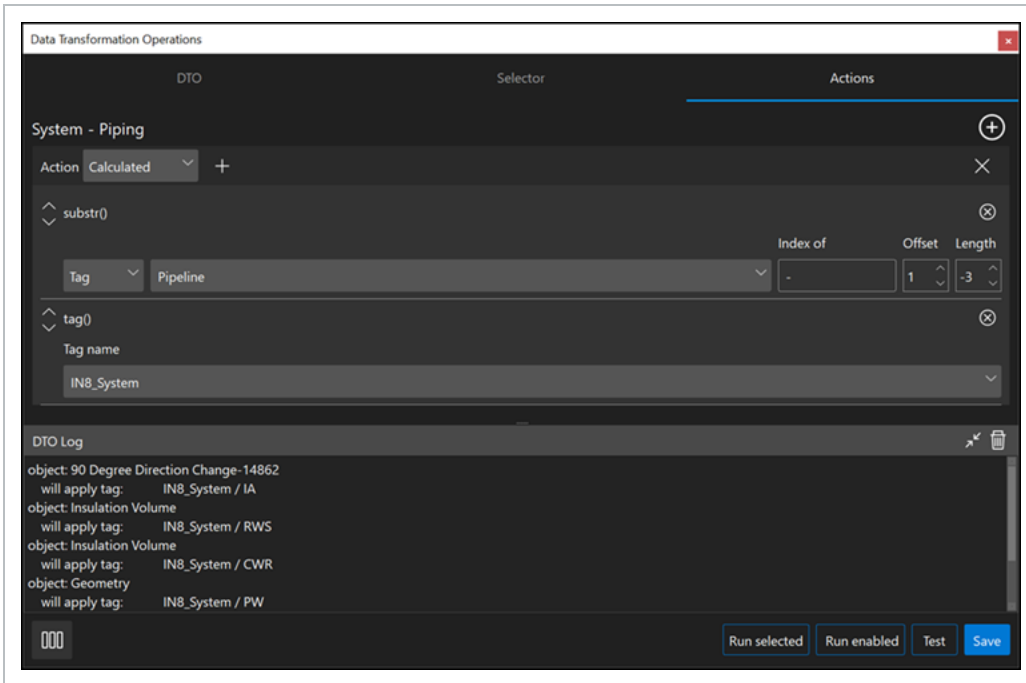

13. Click on the **Run selected** button to execute the DTO, and then create the new tag according to your selection criteria.

Name	Count
IN8_System	185
AQ	127
BD	162
CF	950
CP	280
CWR	248
CWS	606
DMW	1538
DR	804
FP	218
IA	1530
KS	32
NG	42
PW	648
RWS	1702
SC	1053
SL	1516
SM	193
STR	2
UW	966
WW	204
Insulation Material	
Insulation Purpose	
Insulation Thickness	

Tag Selected

13006 objects selected

Filter

1.6 QUANTIFY MODEL DATA

Data Transformation Operations (DTOs) provide flexible and repeatable processes to quantify model data. In the following examples you will see how you can quantify model data using DTOs.

The InEight Model to InEight Estimate integration is the most efficient way to get quantities from a model into an estimate. For more information, see [Model-Estimate overview](#) Overview.

NOTE The following examples do not use the InEight Estimate integration.

1.6.1 EXTRACT QUANTITIES FROM MODEL

You can sum up quantities from your model to use for estimating or tracking subs by installed quantities.

- **1.6.1.1 QUANTITIES BY COUNT**

You can add a DTO to find specific model objects to sum up their quantities, and then utilize the Quantity action type to sum the quantities by count.

Add a DTO, and then name it **Foundation Pier**.

In the **Selector** tab create the following rule criteria:

Rule Type	Tag
Tag / OP Name	02 - Construction Levels
Operator	=
Value	G-Foundations
Exclude	children

Click on the **Add row** icon on the boottom left, and then use the following criteria:

Rule Type	Tag
Tag / OP Name	80 - Construction Items
Operator	=
Value	Drilled Pier

Use the **and/or** row toggle on the top left to select **and**. When you use the **and** toggle, it means that both rules must apply to model objectdata.

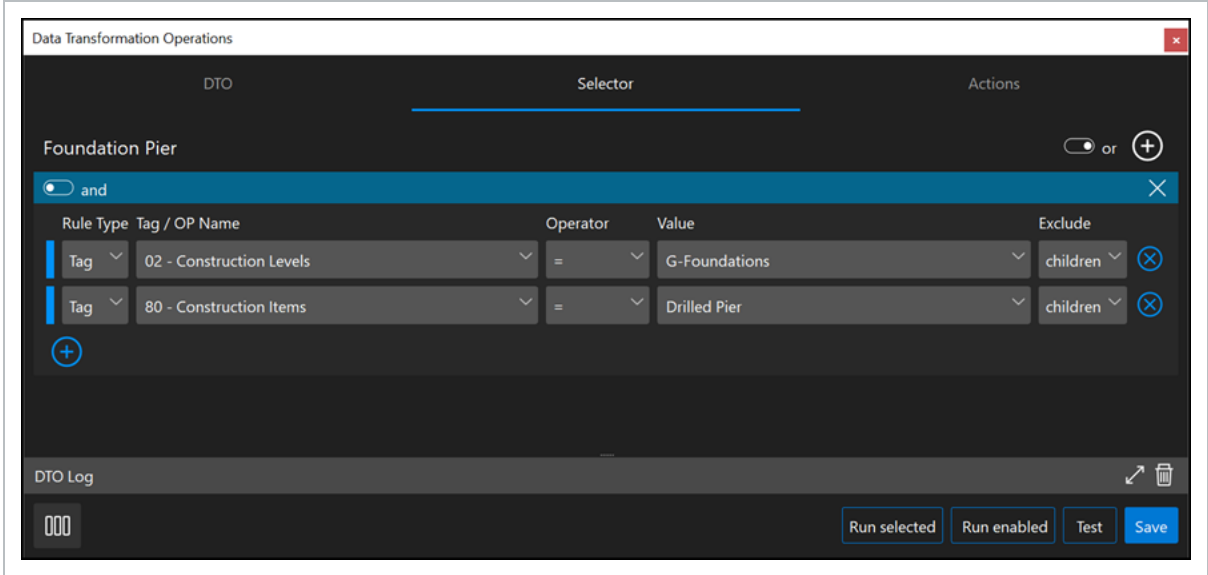

In the **Actions** tab use the following criteria:

Action	Quantity
Quantity Type	count
Code	FND PEIR
Units	Items
Description	Foundation Pier

NOTE You can give the Code and Description fields your own custom input to help organize the data.

Click the **Equals** icon to see your quantities. You can also use the Operation and Value fields to adjust your quantities, and then click the **Equals** icon to see your updated quantities.

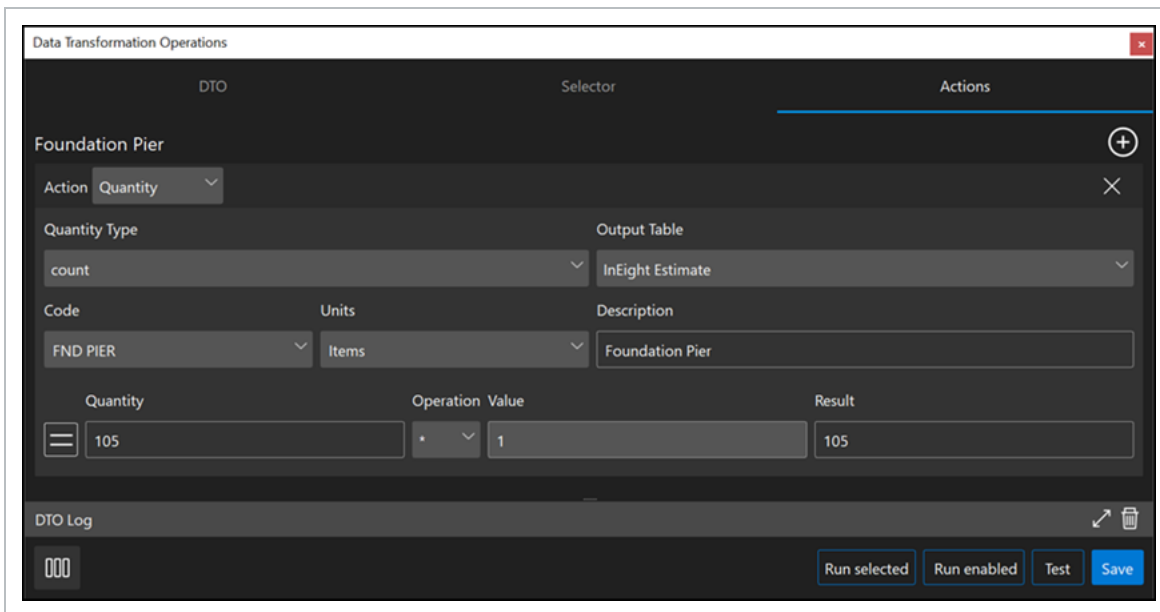

Click the **Run selected** button to execute the DTO and create the new tag according to your selection criteria.

- **1.6.1.2 QUANTITIES BY AREA**

Add a DTO to find specific model object to sum up their quantities and then utilize the Quantity action type to sum the quantities by area.

Add a DTO, and then name it **Foundation Pier**.

In the **Selector** tab create the following rule criteria:

Rule Type	Tag
Tag / OP Name	02 - Construction Levels
Operator	=
Value	G-Foundations

Use the **and/or** toggle at the top left to select **and**.

Click the **Add** icon on the bottom left, and then add the following criteria:

Rule Type	Tag
------------------	-----

Tag / OP Name	80 - Construction Items
Operator	=
Value	Drilled Pier
Exclude	children

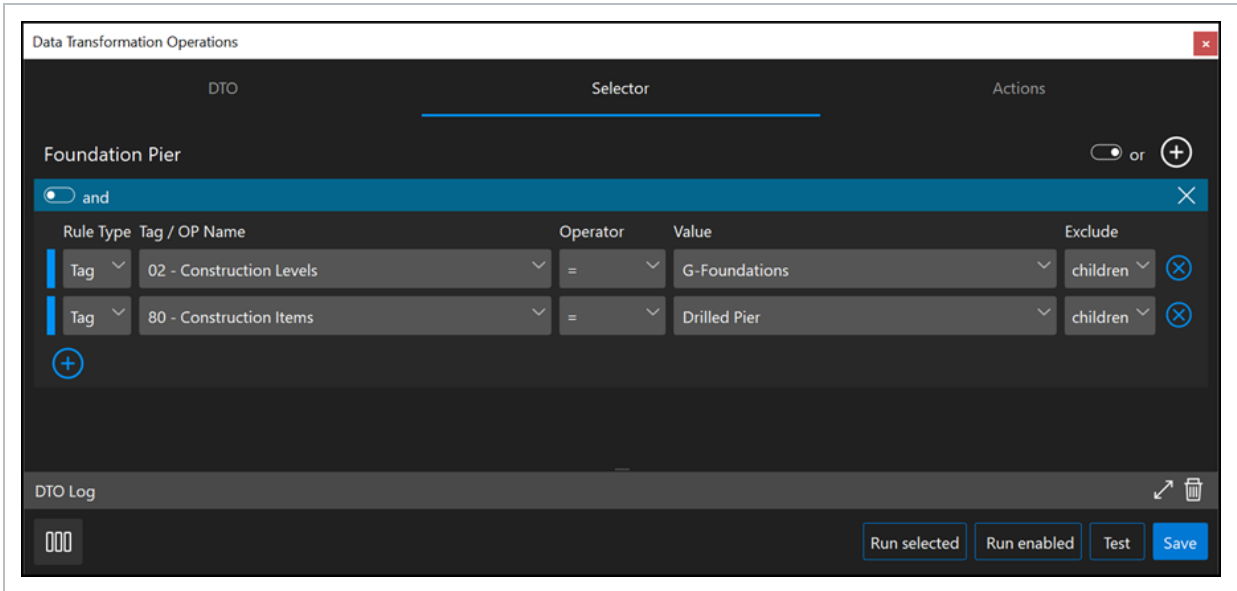

In the **Actions** tab use the following criteria:

Action	Quantity
Quantity Type	sum area
Code	FND PEIR
Units	square feet
Description	Foundation Pier

Click the **Equals** icon to see your quantities. You can also use the Operation and Value fields to adjust your quantities, and then click on the **Equals** icon to see your updated quantities.

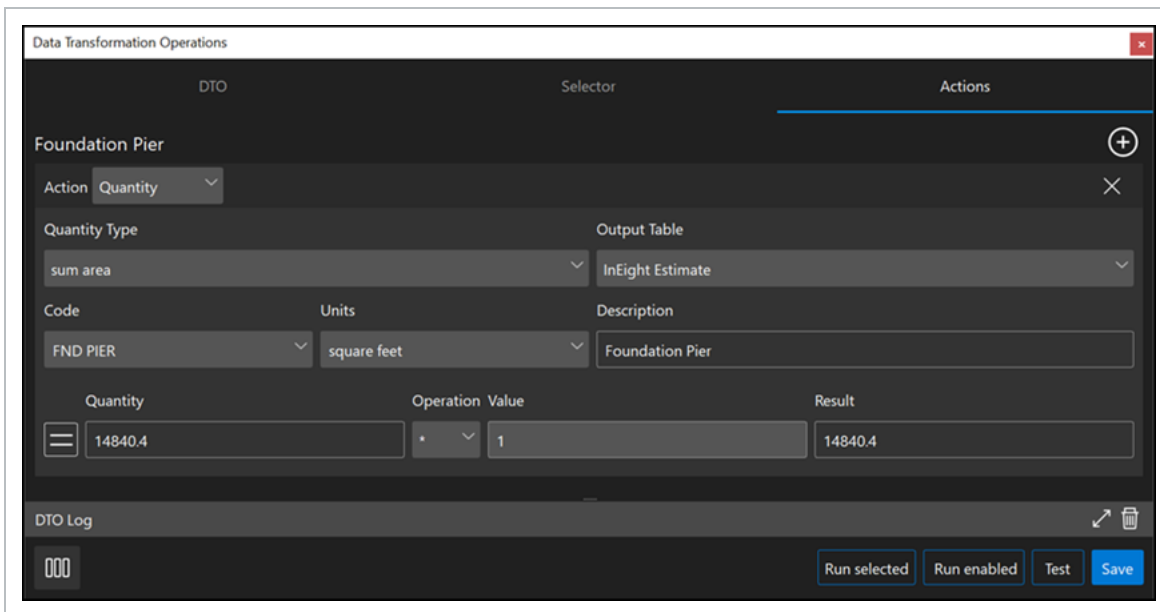

Click the **Run selected** button to execute the DTO and create the new tag according to your selection criteria.

- **1.6.1.3 QUANTITIES BY VOLUME**

You can add a DTO to find specific model object to sum up their quantities and then use the Quantity action type to sum up the quantities by volume.

Add a DTO, and then name it **Foundation Pier**.

In the **Selector** tab create the following rule criteria:

Rule Type	Tag
Tag / OP Name	02 - Construction Levels
Operator	=
Value	G-Foundations

Use the **and/or** row toggle at the top left to select **and**.

Click the **Add row** icon on the bottom left, and then add the following criteria:

Rule Type	Tag
------------------	-----

Tag / OP Name	80 - Construction Levels
Operator	=
Value	Drilled Pier
Exclude	children

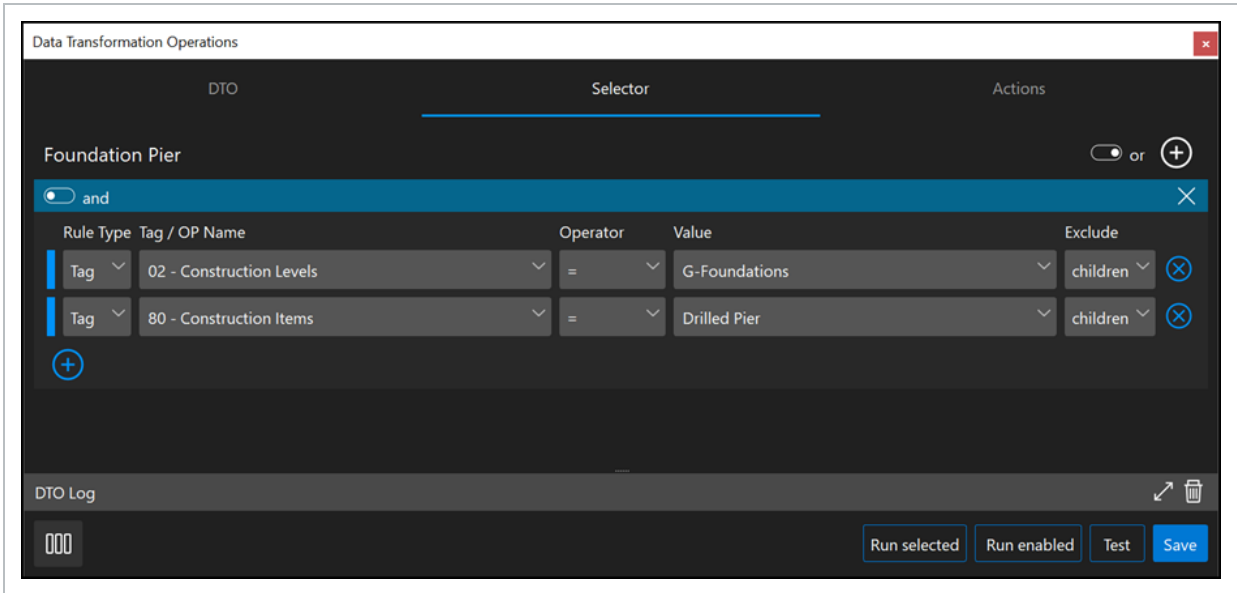

In the **Actions** tab use the following criteria:

Action	Quantity
Quantity Type	sum volume
Code	FND PEIR
Units	cubic yards
Description	Foundation Pier

Click the **Equals** icon to see your quantities. You can also use the Operation and Value fields to adjust your quantities, and then click the **Equals** icon to see your updated quantities.

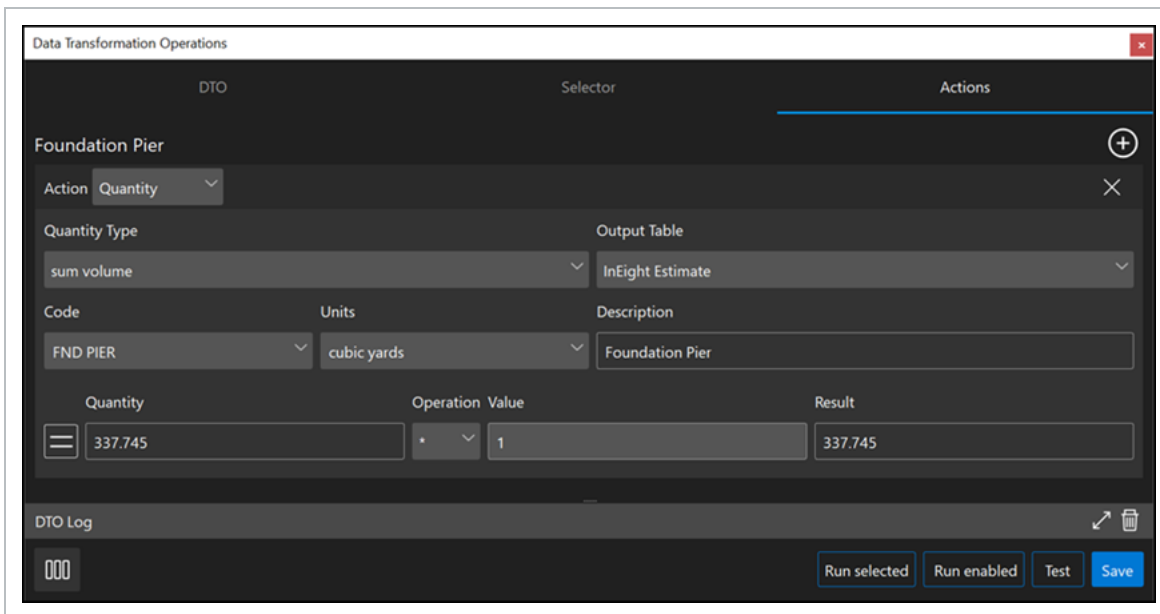

Click the **Run selected** button to execute the DTO and create the new tag according to your selection criteria.

- **1.6.1.4 QUANTITIES BY TAG**

You can add a DTO to find specific model object to sum up the quantities and then utilize the Quantity action type to sum up the quantities using a tag.

Add a DTO, and then name it **Foundation Pier**.

In the **Selector** tab create the following rule criteria:

Rule Type	Tag
Tag / OP Name	02 - Construction Levels
Operator	=
Value	G-Foundations
Exclude	children

Use the **and/or** row toggle at the top left to select **and**.

Click the **Add row** icon on the bottom left, and then add the following criteria:

Rule Type	Tag
Tag / OP Name	80 - Construction Levels
Operator	=
Value	Drilled Pier
Exclude	children

In the **Actions** tab use the following criteria:

Action	Quantity
Quantity Type	sum property
Tag	IN8_Area (sf)
Code	FND PEIR
Description	Foundation Pier

Click the **Equals** icon to see your quantities. You can also use the Operation and Value fields to adjust the quantities, and then click the **Equals** icon to see updated quantities.

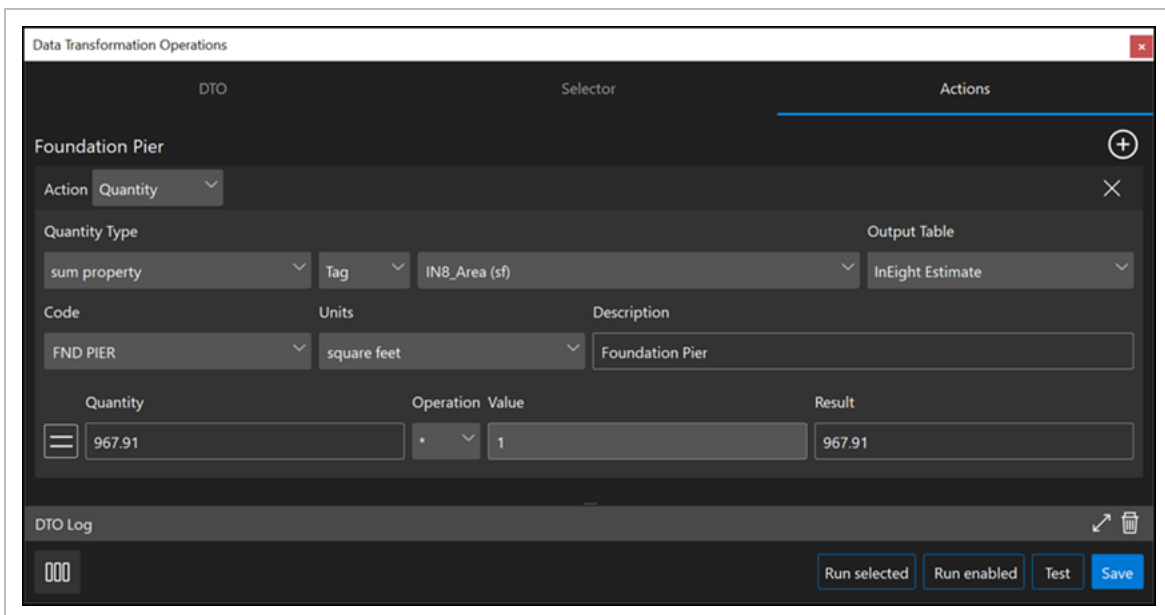

Click the **Run selected** button to execute the DTO and create the new tag according to your selection criteria.

- **1.6.1.5 ACCESS QUANTITIES VIA EXCEL PLUG-IN**

Model has a plug-in for Microsoft Excel to access model quantities. To download the Excel Plug-in Installer go to [InEight Downloads](#).

After you install the plug-in, the InEight menu will show in the top menu ribbon of Excel.

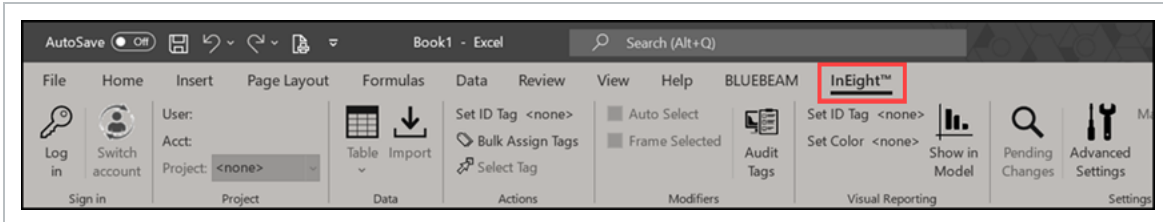

Model and Excel interact with each other without the need to have the Excel application open. However, the data created using quantity DTOs uses tables. You must be logged in to Model via Excel to access the table data.

When you click on the InEight tab in Excel, you can log in using the same credentials you use for Model.

Click Table-> admin-> config-> DTO-> DTO Estimate Record-> **Query All**.

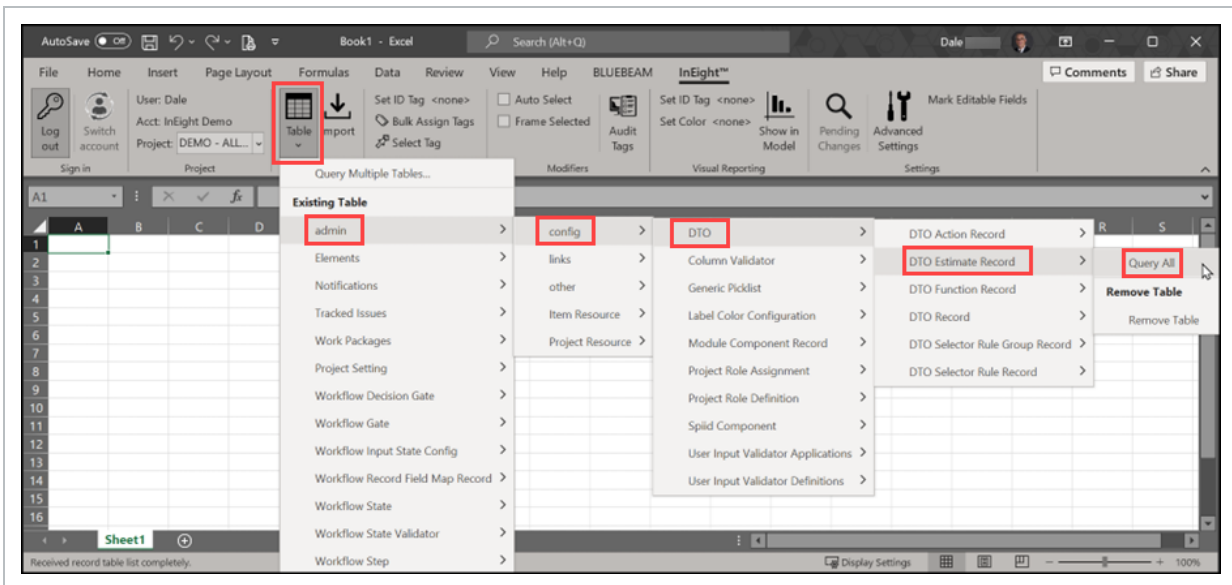

The results of the Quantity DTOs executed in Model will show.

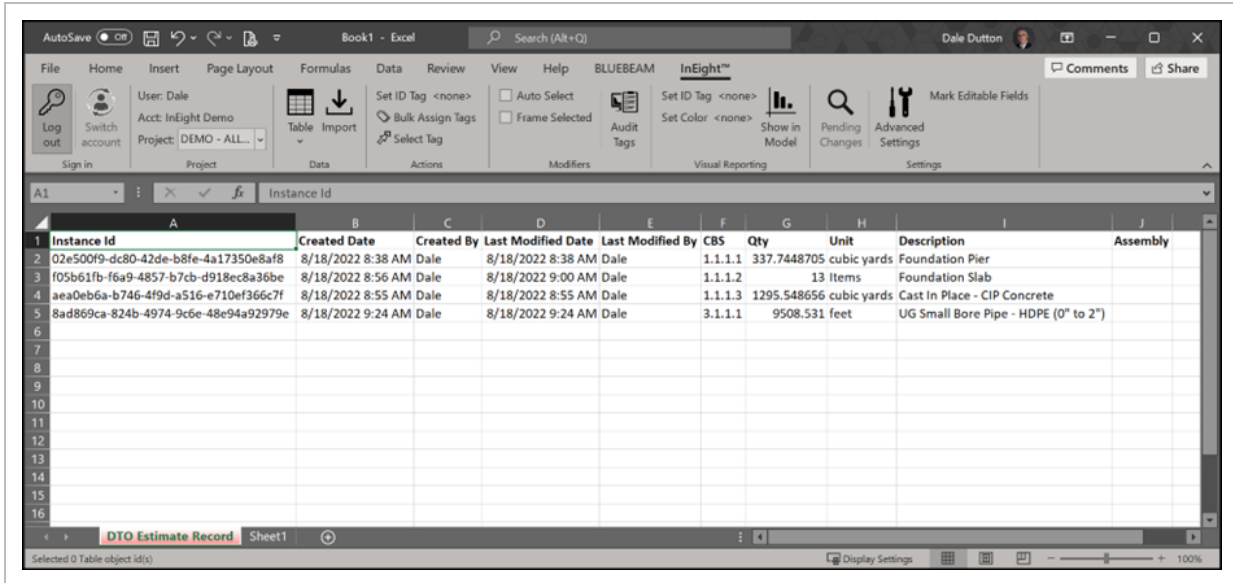

1.7 VALIDATE MODEL DATA

Data Transformation Operations (DTOs) provide flexible and repeatable processes to validate model data. In the following examples you will see how you can find model objects that do not have certain values or validate specific model data format. This information can be used to communicate any model data that does not meet project requirements.

1.7.1 VALIDATE MODEL DATA IS COMPLIANT

You can validate that specific model data meets your project requirements.

VALIDATE SPECIFIC MODEL DATA EXISTS

You can find model objects that do not have certain values, such as length.

1. Add a new DTO, and then name it **W Shapes have no LENGTH**
2. In the **Selector** tab use the following criteria:

Rule Type	Tag
Tag / OP Name	Revit_Family_Type

Operator	contains
Value	W Shape

- Use the **and/or** row toggle on the top left and change it to **and**.
- Click the **Add row** icon under the row, and then use the following criteria:

Rule Type	Tag
Tag / OP Name	Length
Operator	is null

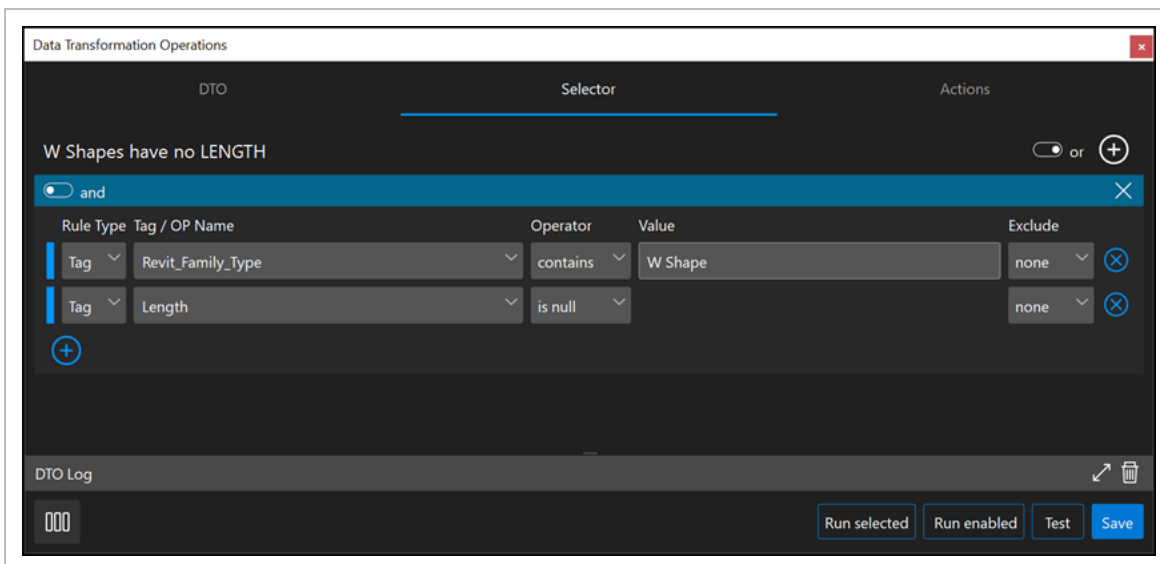

- Click the **Actions** tab, and then use the following criteria:

Action	Tag
Tag Name	99 - Validation Issue
Tag Value	No Length

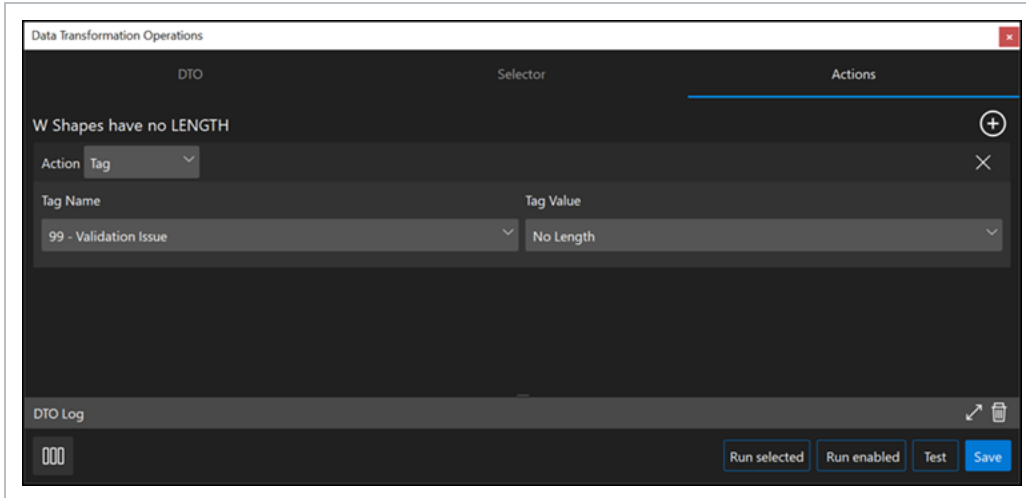

6. Click the **Run selected** button to execute the DTO and create the new tag according to your selection criteria.

VALIDATE MODEL DATA FOR SPECIFIC FORMAT

You can validate that your Pipeline data has the system prefix followed by a dash, such as AQ-0001065.

First add a DTO to tag to all relevant data as invalid, and then create another DTO to find validated data. The purpose is to place the invalid and valid tag values in the same tag name. When you use the same tag name, the invalid data will switch to validated because an object can only have one value in a tag name.

You must run both DTOs at the same time, and in the correct order in the list. First run invalid data, and then validated data.

1. Add a new DTO group, and then name it **Validation**. Add a new DTO in the group for all Pipeline data that will be tagged as invalid data, and then name it **Pipeline – Invalid**.

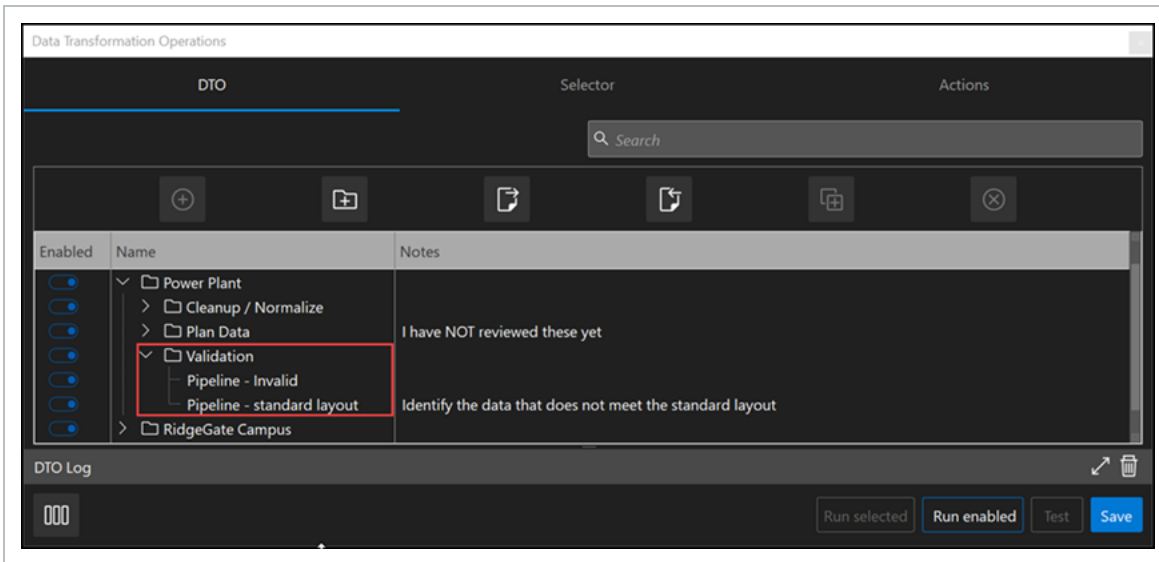

2. In the **Selector** tab create the following criteria:

Rule Type	Tag
Tag / OP Name	Pipeline
Operator	not null

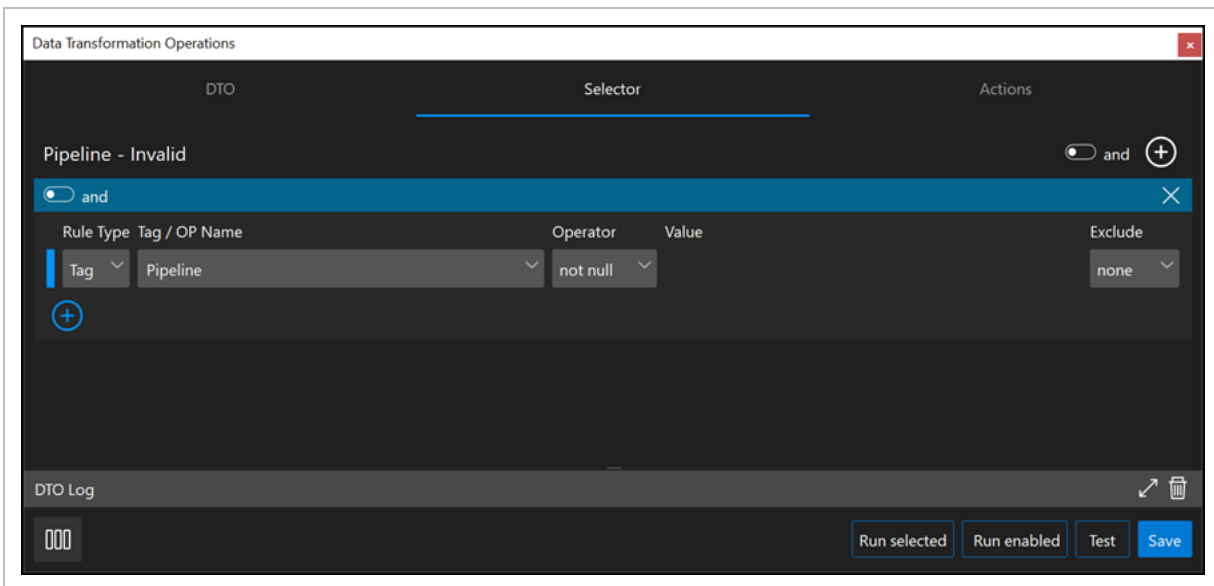

3. In the **Actions** tab use the following criteria:

Action	Tag
Tag Name	IN8_Validation - PowerPlant
Tag Value	Pipeline - Invalid

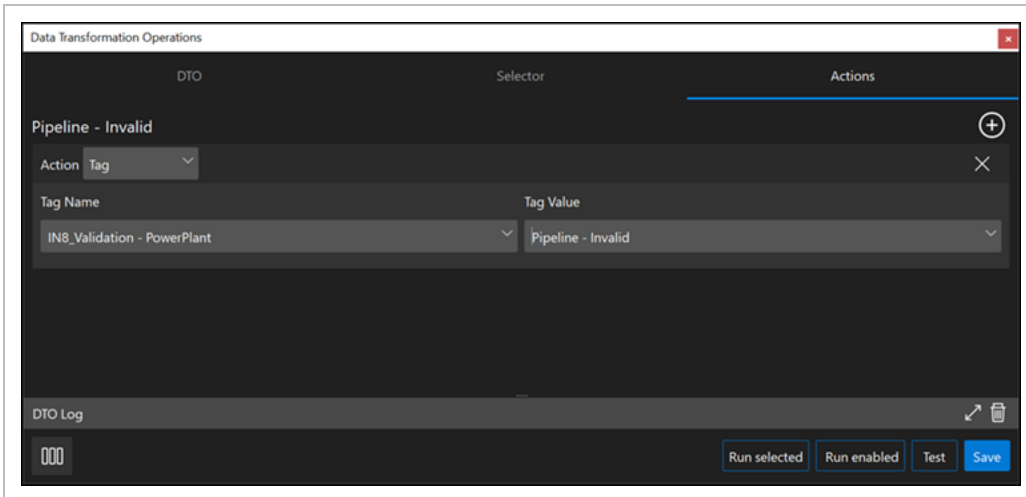

4. Click the **Run selected** button to execute the DTO and create the new tag according to your selection criteria.
5. Add another DTO in the group for all Pipeline data that will be tagged as valid data, and then name the new DTO **Pipeline – standard layout**.
6. In the **Selector** tab create rule criteria to find all piping systems followed by a dash.

Rule Type	Tag
Tag / OP Name	Pipeline
Operator	contains
Value	List AQ- through WW-
Exclude	none

7. Use the **and/or** row toggle on the top left to select **or**.
8. Click the **Add row** icon on the bottom left to add new rows, and then include all your values.

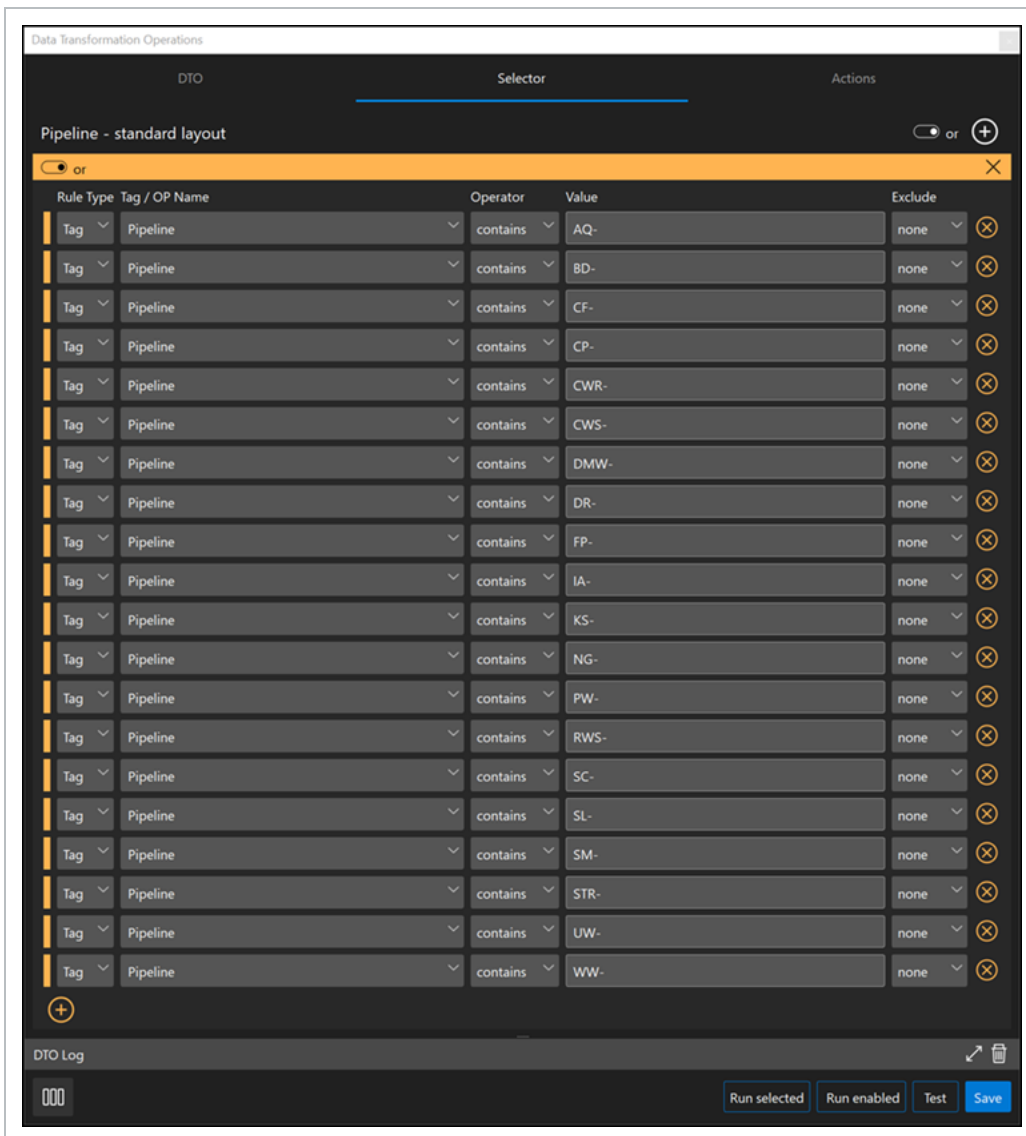

9. In the **Actions** tab use the following criteria:

Action	Tag
Tag Name	Tag = IN8_Validation
Tag Value	Pipeline - Validated

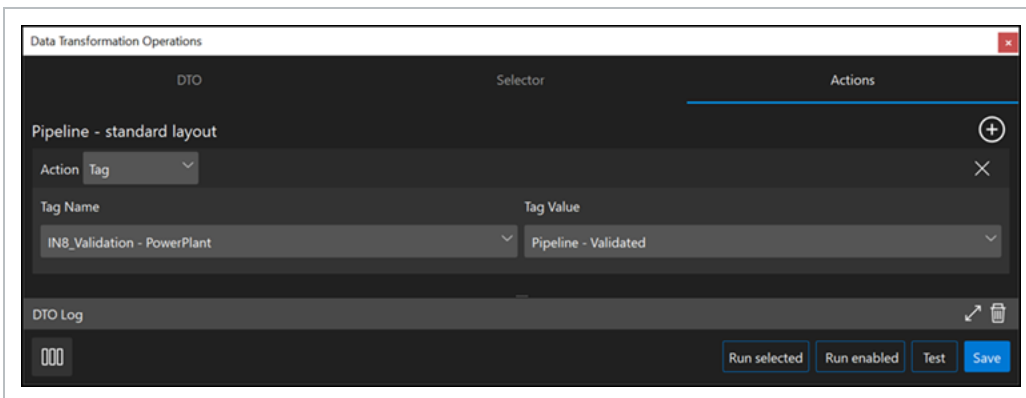

10. Click on the **Run selected** button to execute the DTO and create the new tag according to your selection criteria.

CHAPTER 2 – STYLES

2.1 STYLING OVERVIEW

Materials and colors are not fixed, or assigned universally to all model objects, like they are in other modeling environments. You have the flexibility to view the model in the way that makes sense for yourself. In Model, you need to remember:

- Styles are the materials or colors in Model
- Style Sets are collections of assigned Styles

Styles allow you to switch between Style Sets to change the way you visualize the model. For example, creating a Style Set that emphasizes a system, such as HVAC, or a Style Set that has the colors to conform to an owner's requirements. With these visually highlighted, it helps to identify those areas which you want to focus on when looking at the model.

The Styling panel allows the manipulation of the appearance (surface and line, color and transparency) of geometry. There are two tabs in the Style panel: Styles and Style Sets.

2.1.1 LAUNCH STYLING MENU

To access the Styling panel, select **View > Styling**.

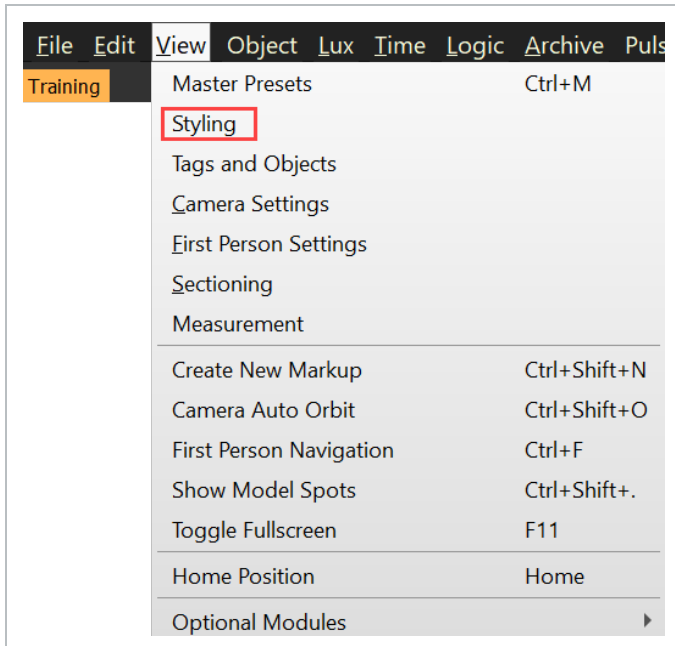

- This will open the Styling window.

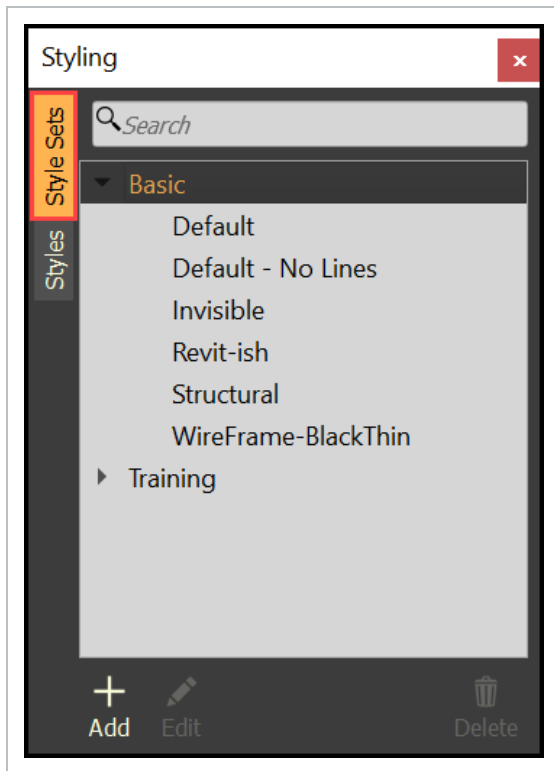

2.2 CREATE AND MANAGE STYLE SETS

There are predefined style sets grouped under Basic when a project is created. New style sets can be created to represent real-world material characters such as glass and steel, or simple colors, to represent different disciplines or systems.

NOTE

The predefined style sets cannot be edited. They can be duplicated to create new, custom style sets.

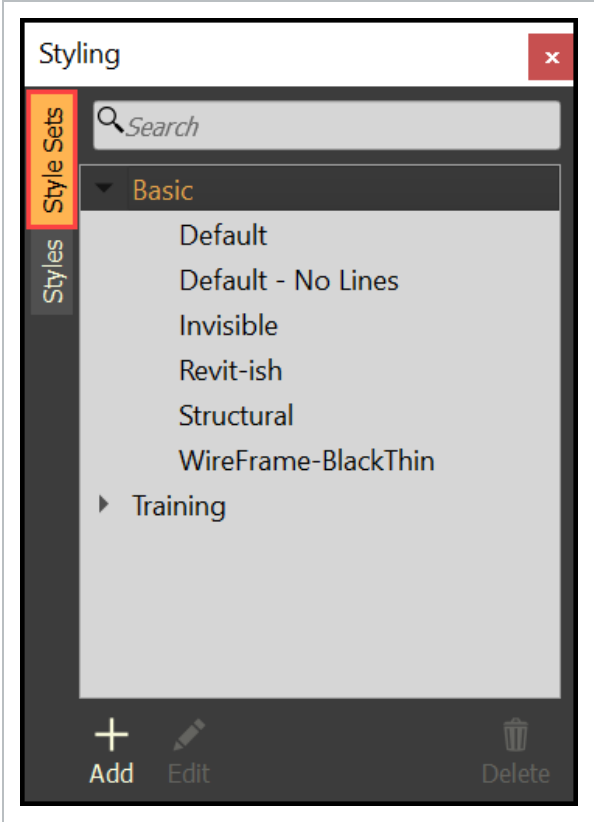

2.2 STEP BY STEP 1 – CREATE A STYLE SET

1. Select **Add**.

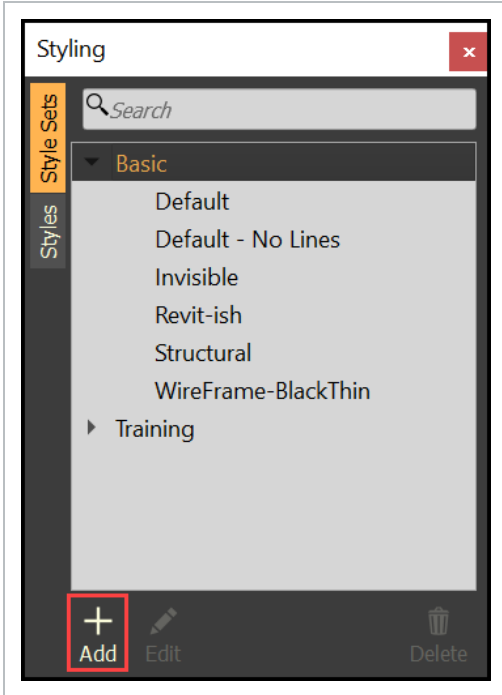

- The New Style Set dialog box will open

2. Type in a desired name for your new style set (i.e. Major Systems).

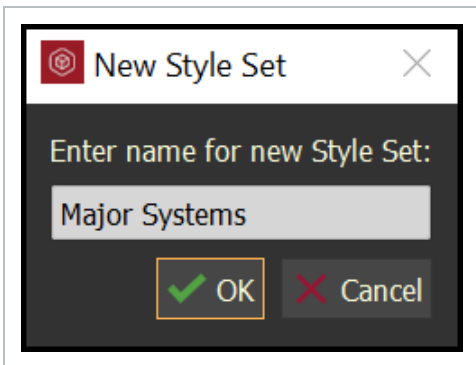

3. Click **OK**.

- The new style set will be grouped under the project name

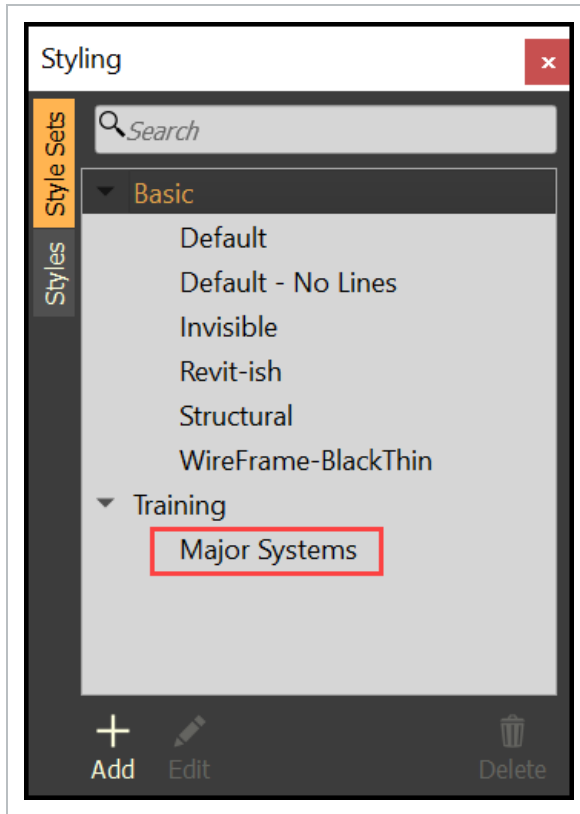

4. Select the style set to make it active.

- Any styles applied will be a part of the active style set

2.2 STEP BY STEP 2 – EDIT A STYLE SET

Once one or more styles have been applied to a style set, the style set can be managed.

1. Select a style set.

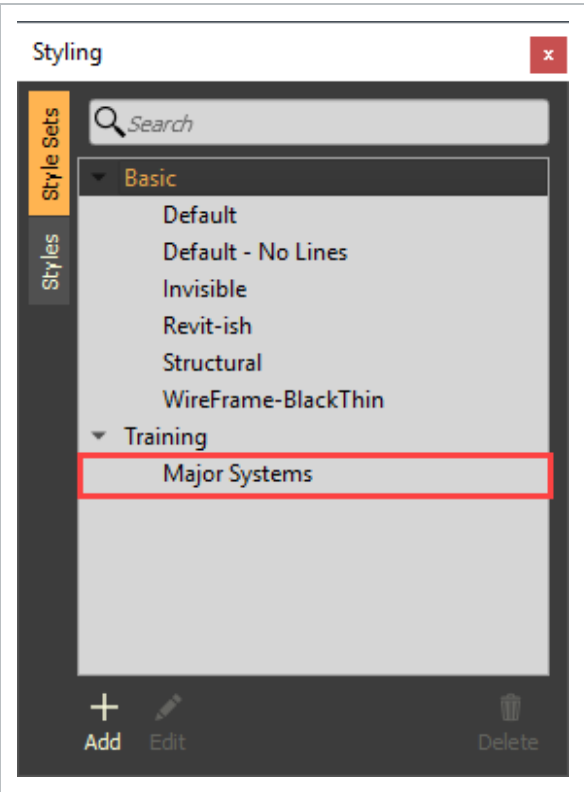

2. Select **Edit**.

- The Edit Style Set dialog box will open

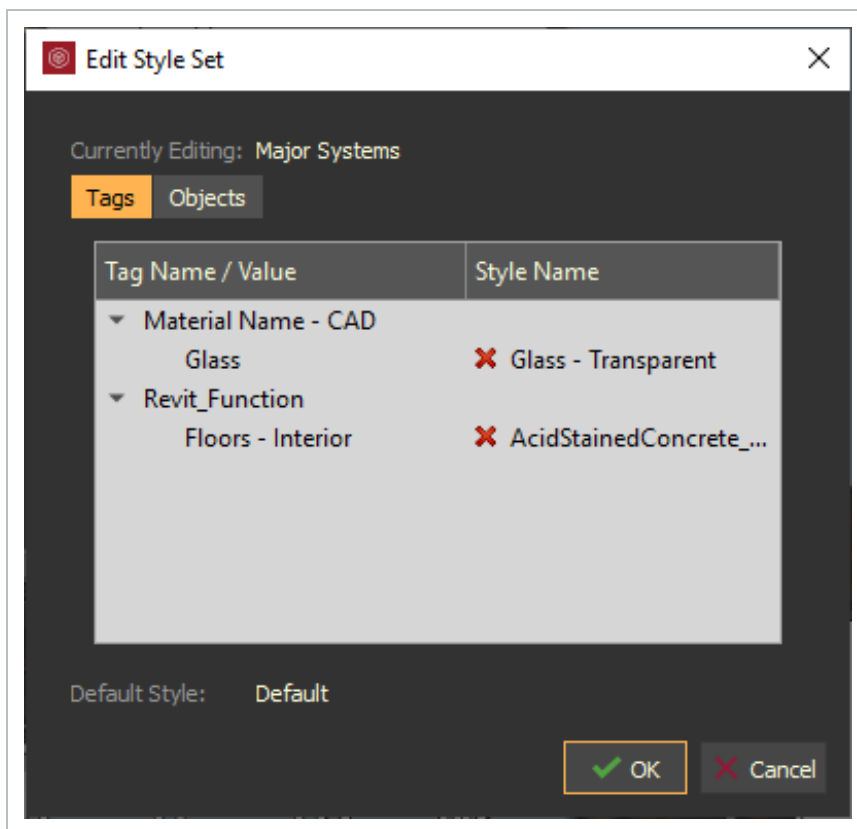

- To remove a style, click the **red X**.
- To reorder styles, **drag a style** up or down within the list.

NOTE When multiple style assignments apply to an object or tag, those higher in the list take precedence.

3. When finished, select **OK**.

2.2 STEP BY STEP 3 – DELETE A STYLE SET

1. Select a style set, then click the **Delete** icon.
 - Or, right click on the style set, then select **Delete Selected Style Set**

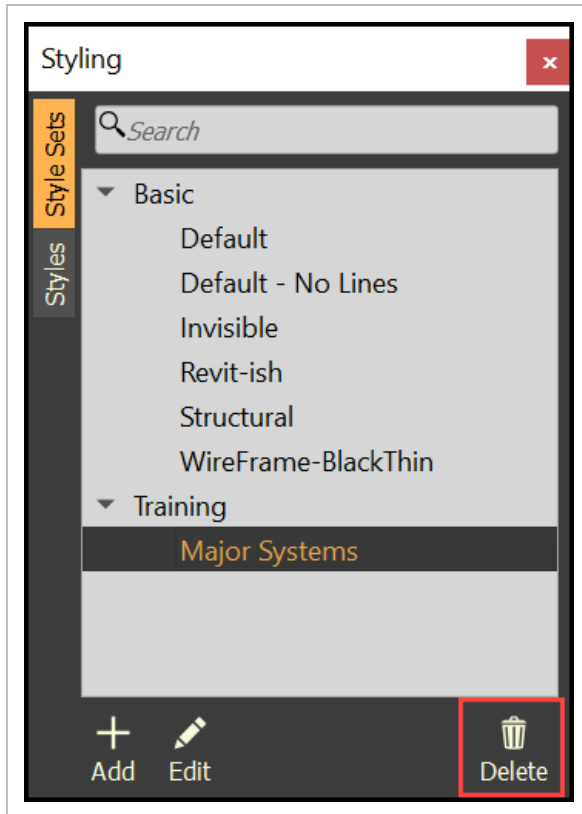

2.3 CREATE AND EDIT STYLES

There are predefined styles, which cannot be modified, but can be duplicated to create a new style. All newly created styles will be grouped under the project name.

2.3 STEP BY STEP 1 – CREATE A NEW STYLE

1. Select the **Styles** tab and then select **Add**.

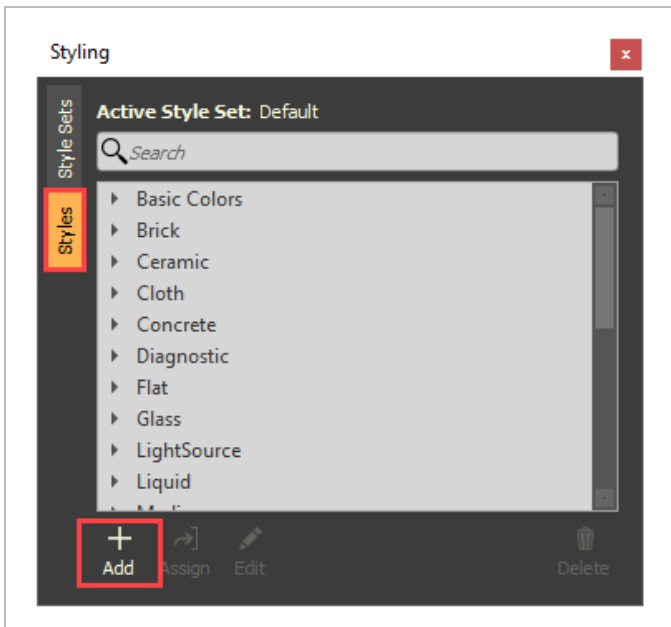

- The Edit Style window will open

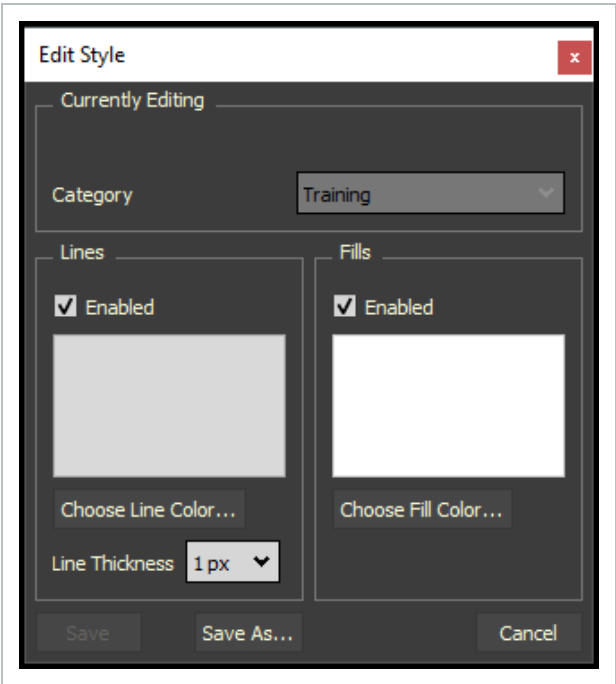

2. Click **Choose Line Color...**

- Or toggle the Enabled box to have no outline color

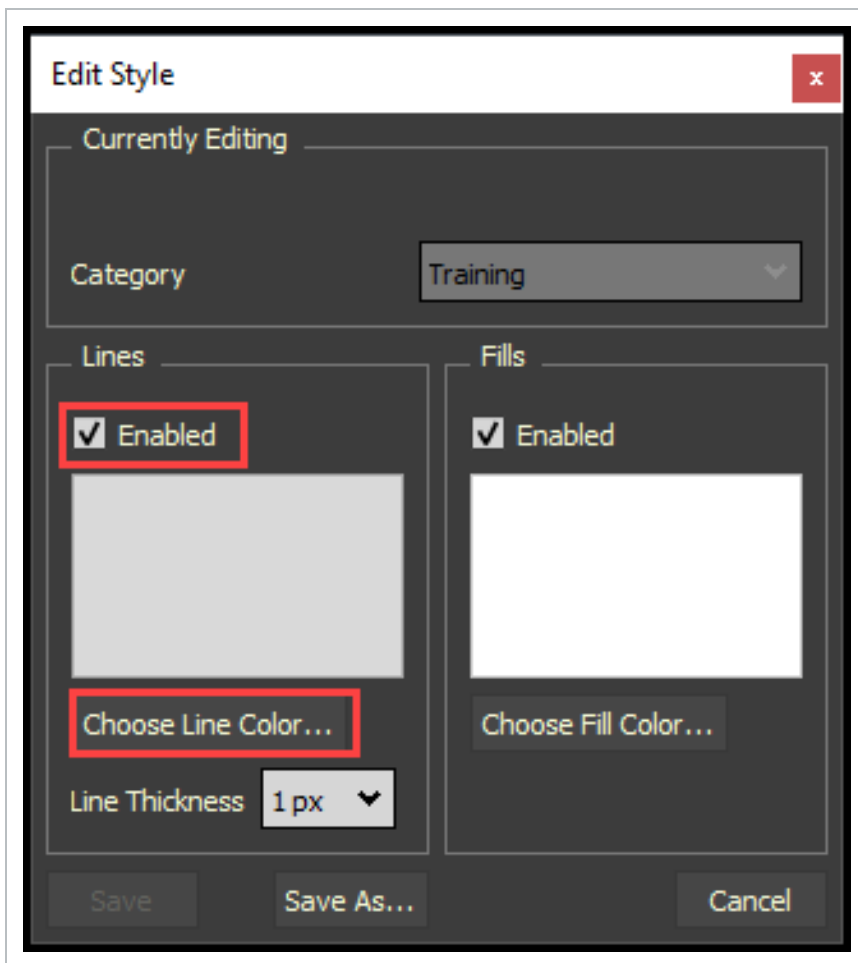

- The Select Color dialog box will open

3. Select your desired color and click OK.

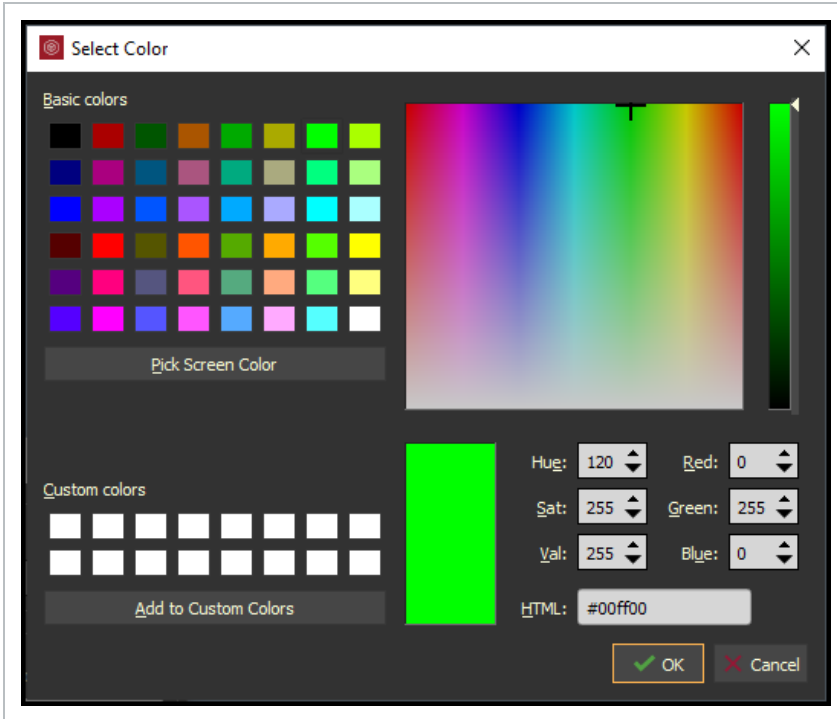

4. Change the line thickness as desired.

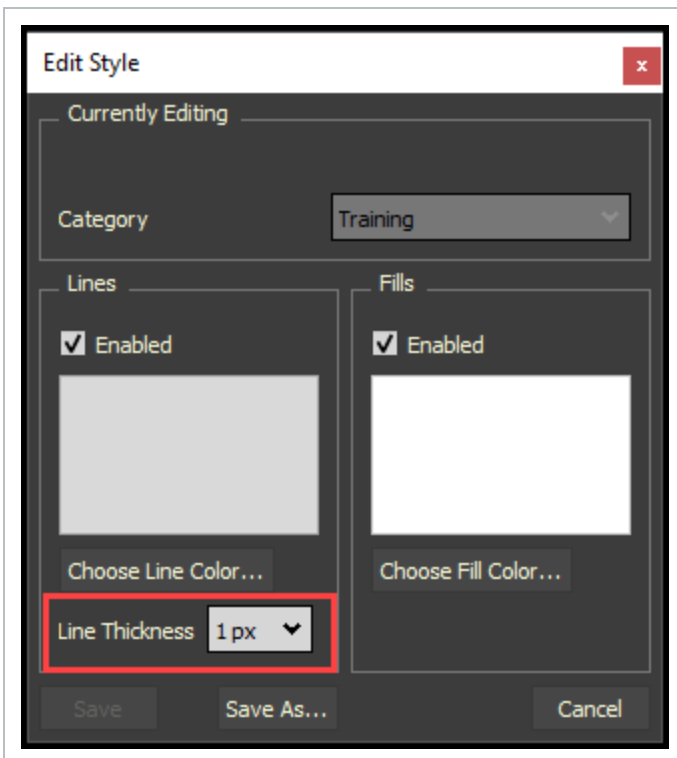

5. Click **Choose Line Color**.

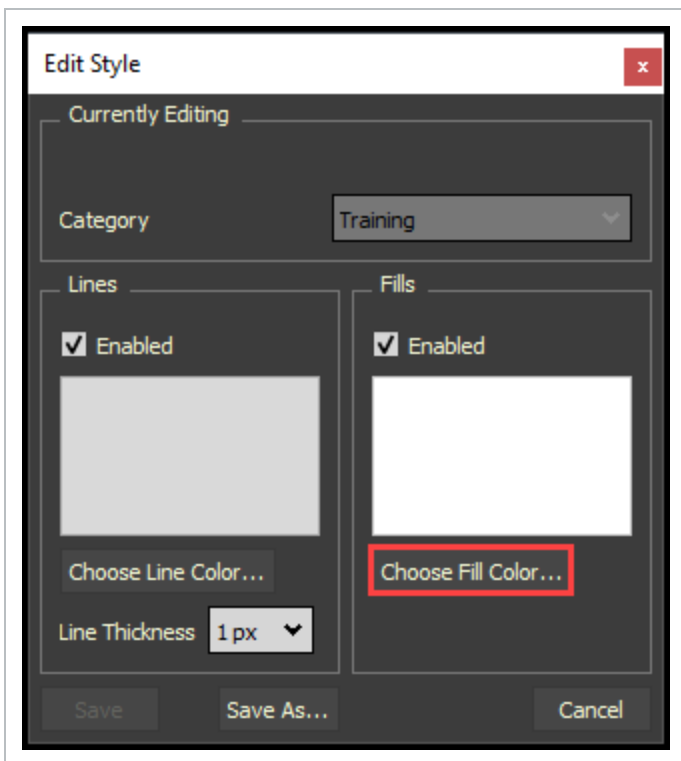

- The Select Fill Color dialog box will open

6. Select you desired color and set an opacity if desired, then click **OK**.

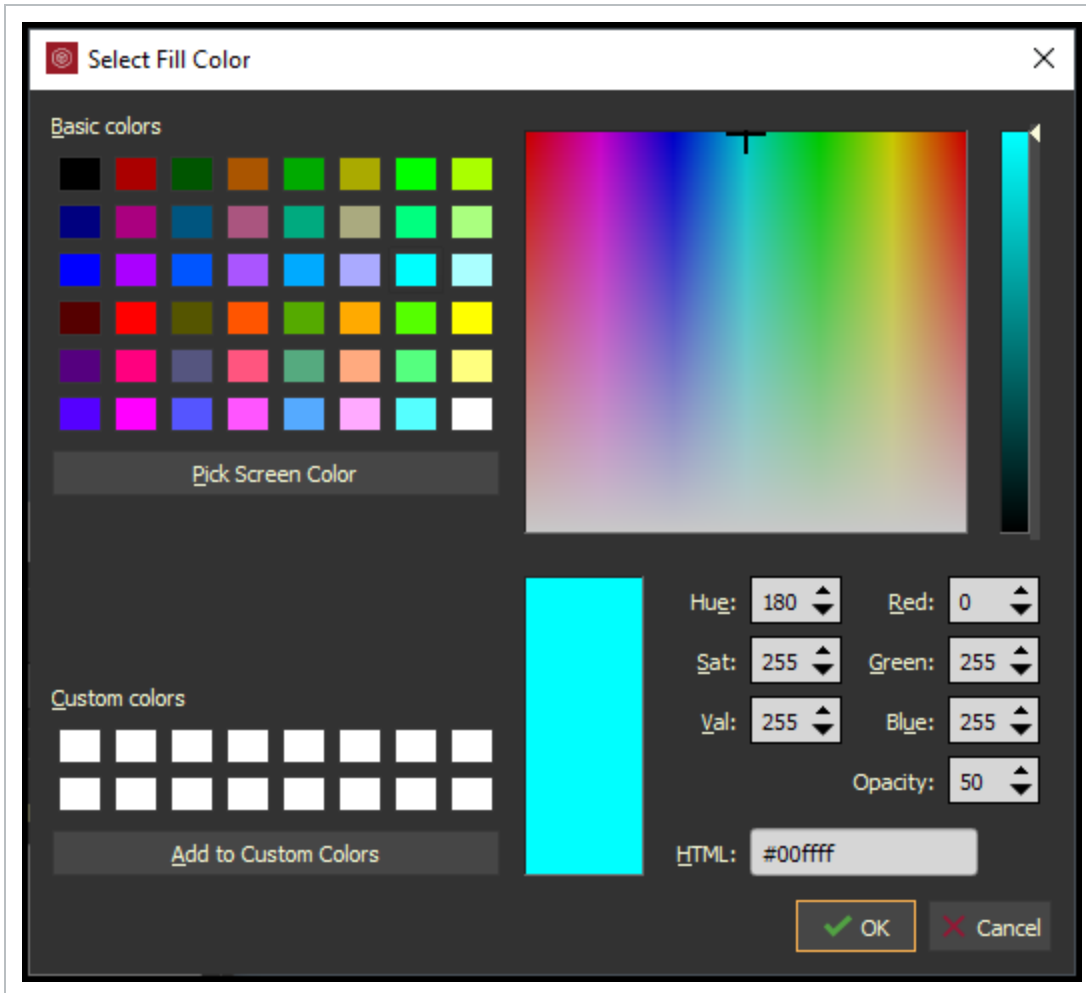

7. Select **Save As...** to save as a new style (i.e. Glass – Transparent).

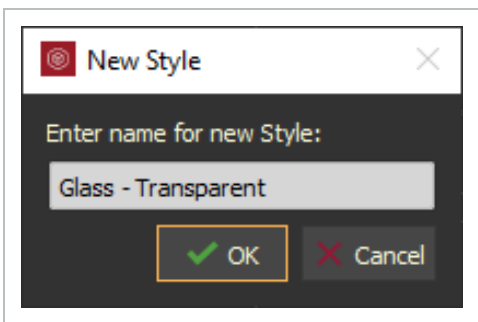
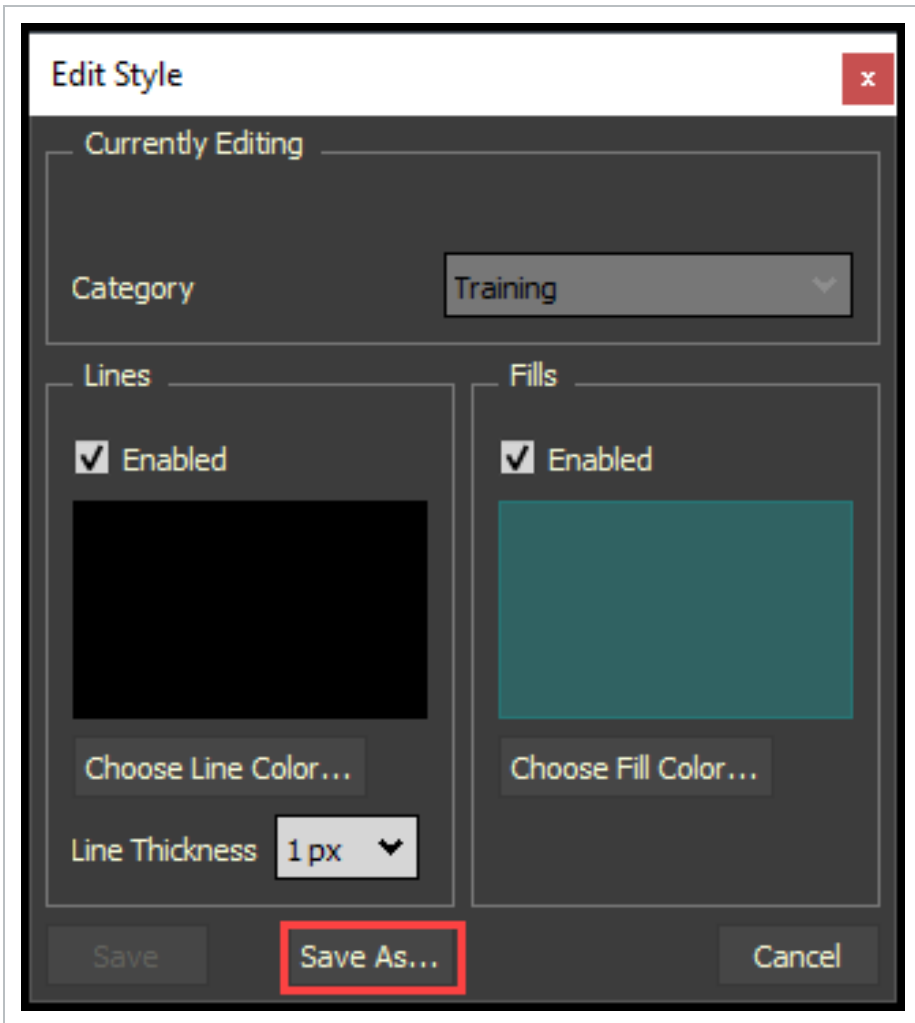

- The new styles will be grouped under the project name

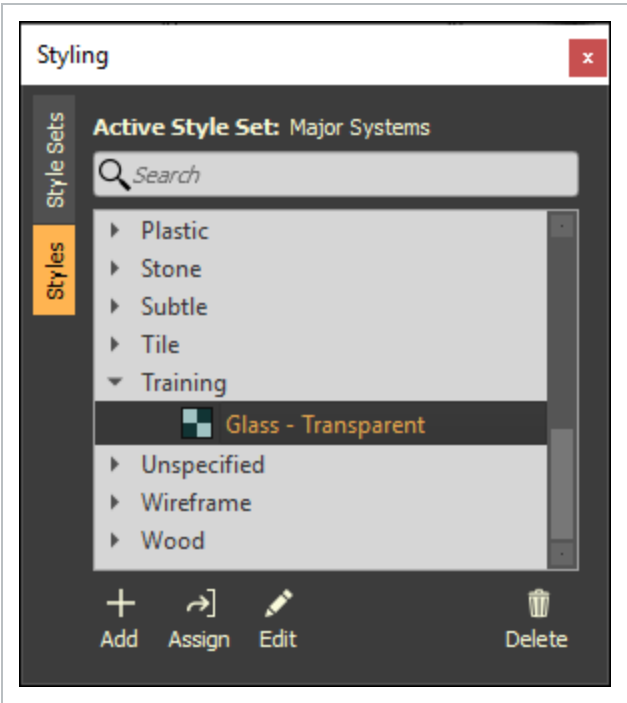

2.3 STEP BY STEP 2 – EDIT A STYLE

- 1. Select a Style Set, then click the **Edit** icon.

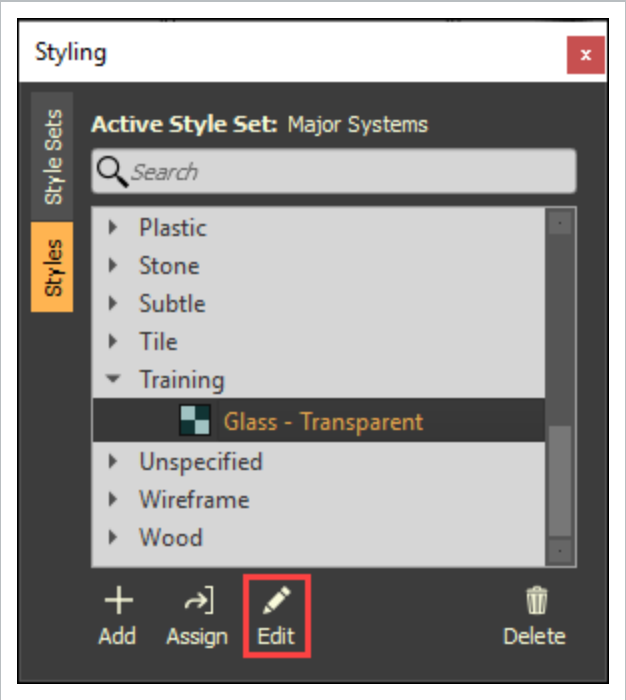

2.3 STEP BY STEP 3 – SET A STYLE AS A DEFAULT

1. Select a style, then right click and select **Make default for selected StyleSet**.

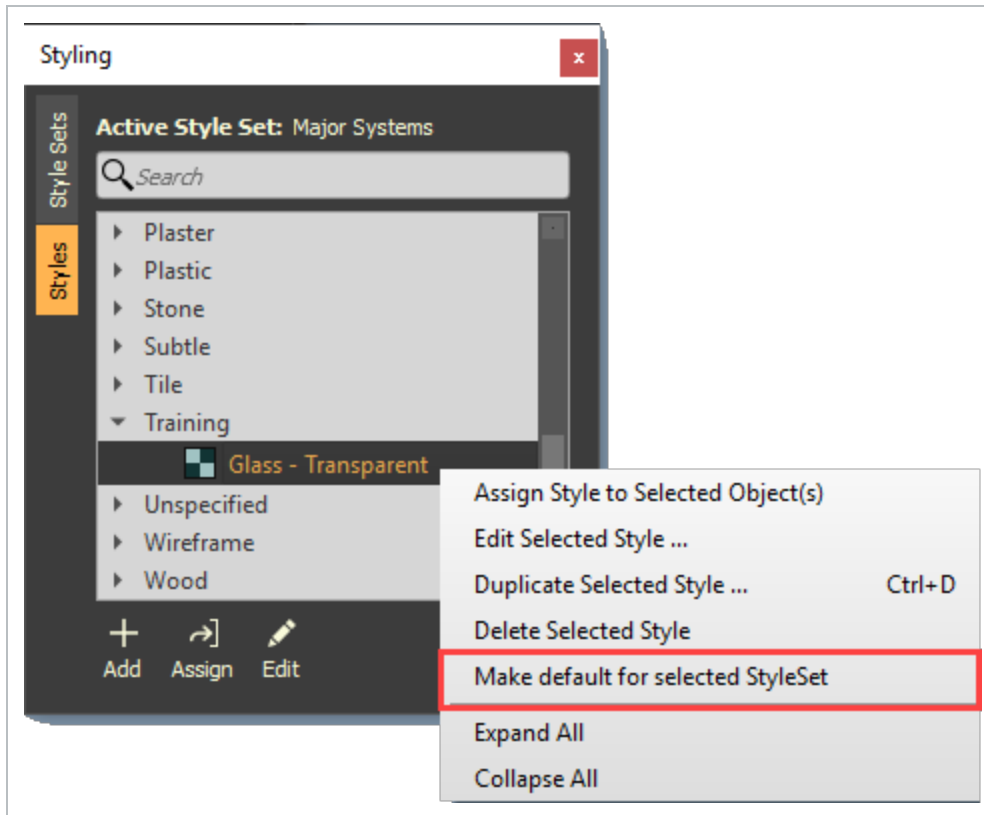
**TIP**

Once Styles are assigned, then any style can be identified as the default (i.e. Transparency).

2.3 STEP BY STEP 4 – DELETE A STYLE

1. Select a style, then click the **Delete** icon.
 - Or, right click on the style set, then select **Delete Selected Style**

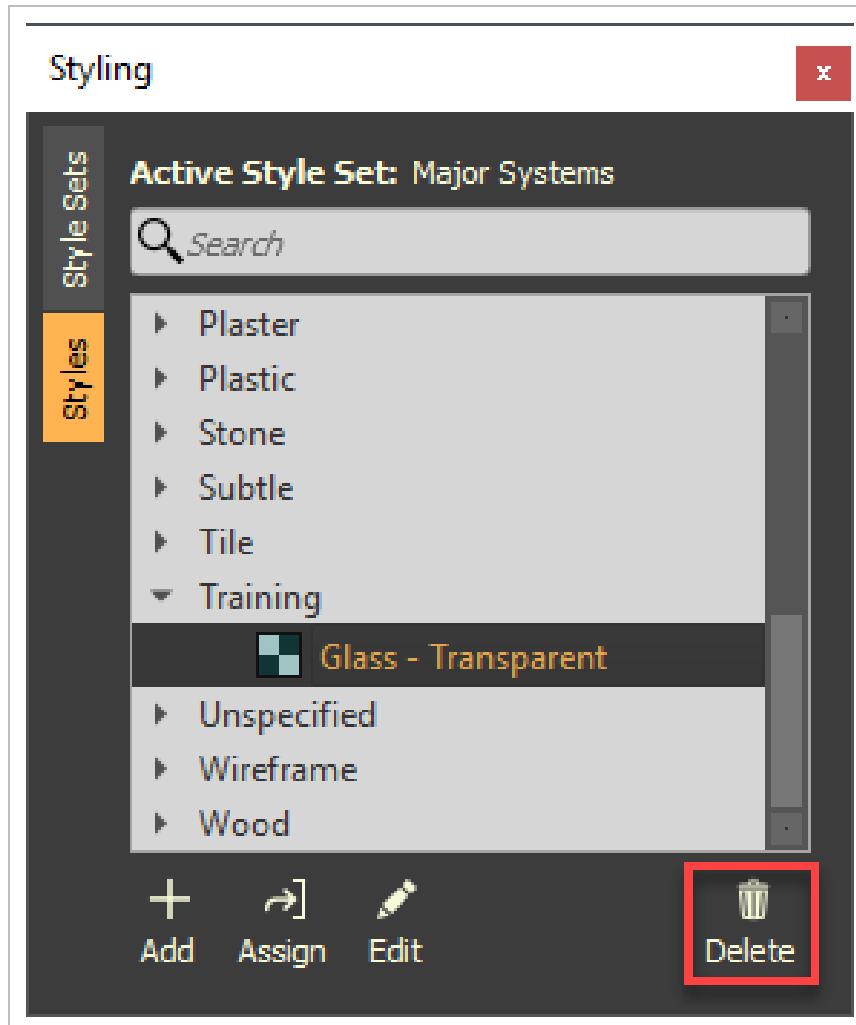

2.4 APPLY STYLES TO TAGS

Styles are appearance definitions. Assigning a style to a tag will change the appearance of model objects with that tag. When a Style Set is active, it will be denoted at the top of the Styling panel.

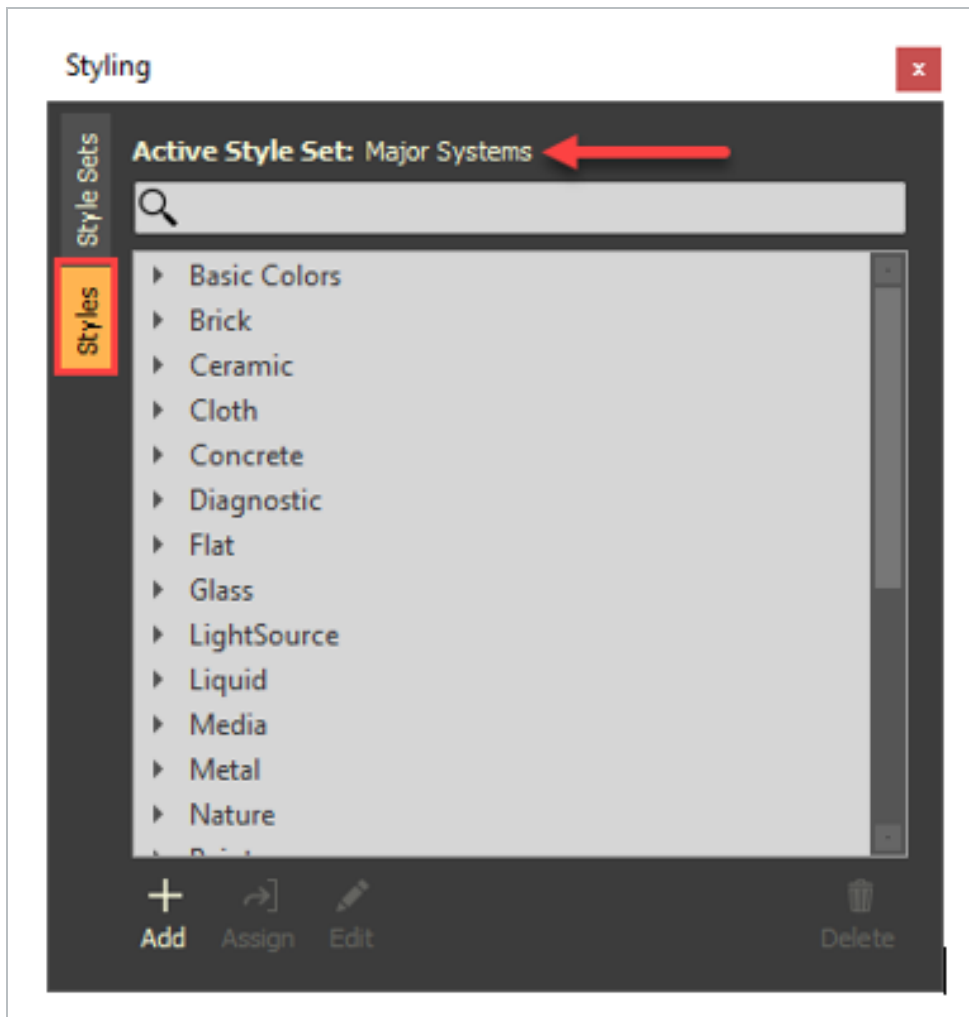
**TIP**

Styles can be applied to objects or tags; however, it is always preferable to use tags whenever possible as this provides greater flexibility.

NOTE

If a style was applied to an object and that object was removed and redrawn within the design software, then that object will no longer be assigned the style.

2.4 STEP BY STEP 1 – APPLY A STYLE TO A TAG

1. Select a **tag** withing the Tags panel.
 - This will select model objects
2. Withing the Styles tab, select a **style**, then click **Assign**.

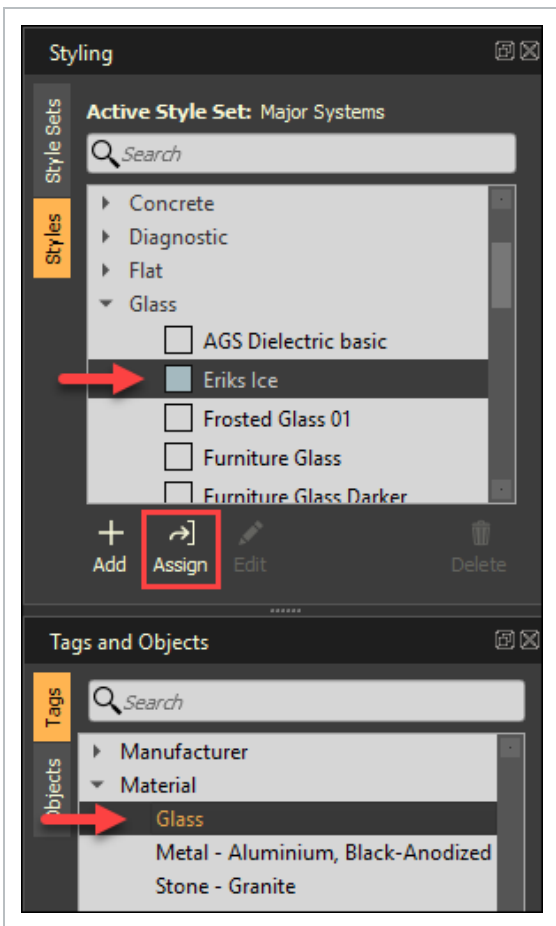

- Or, drag and drop a style on top of a tag

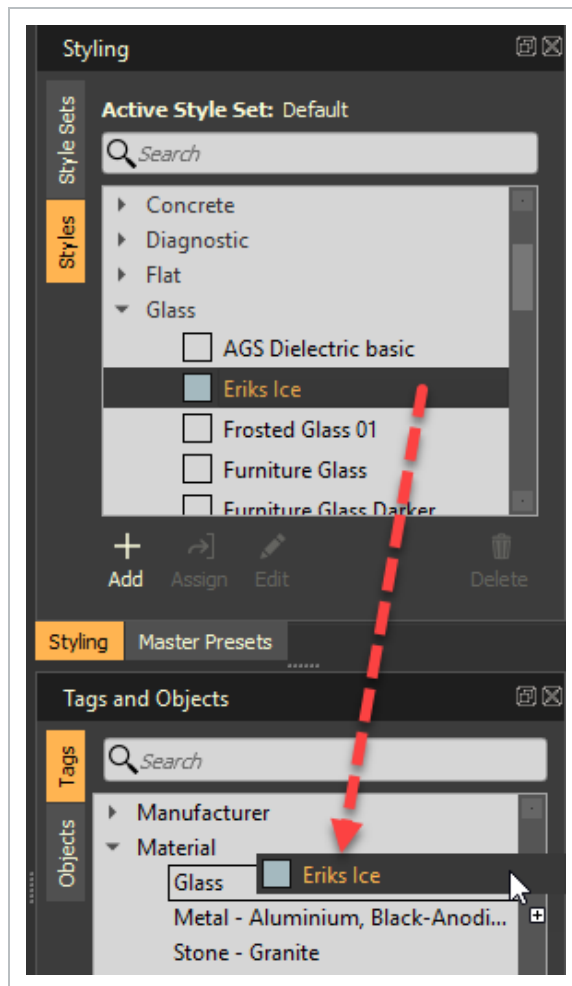

- This method will not select model objects

2.5 ASSIGN STYLES USING EXCEL

Before beginning, ensure you have only one instance of InEight Model and one instance of Excel open. Matching unique tag category and values need to be in the model and in Excel.

Within the Tags and Objects menu, identify a Category Name and its values. For this example, the Tag Category will be Material and the Values are also shown as Glass, Metal and Stone.

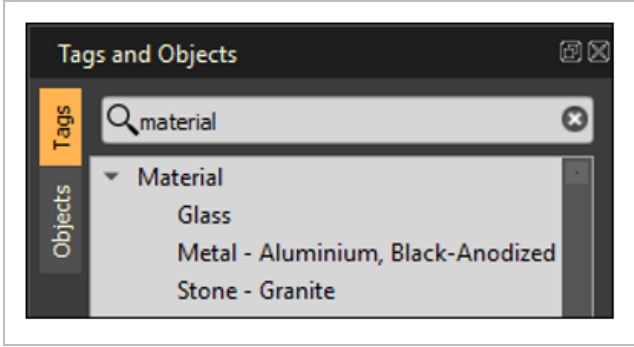

In Excel, type the tag and object names into the first cell on the Excel sheet.

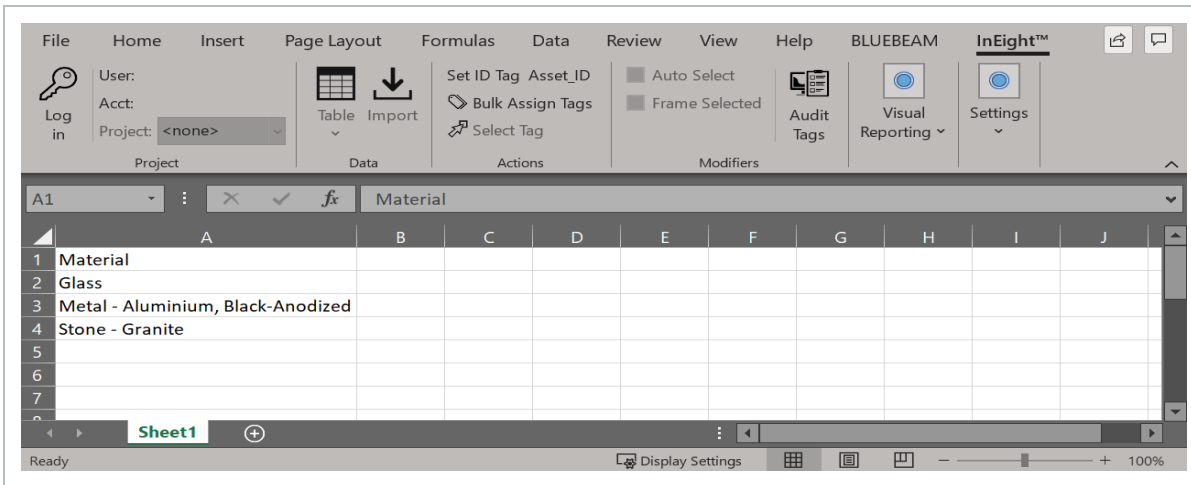

Now that there is a unique tag category with values within excel that match the model, a style set can be pushed from excel into the model.

2.5 STEP BY STEP 1 – COLOR EXCEL CELLS

1. Add color to the cells.

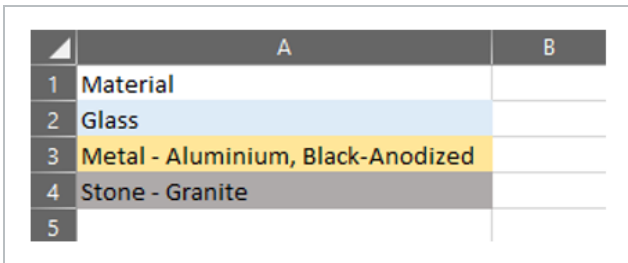

2. Within the Excel menu bar, select the **InEight** tab.

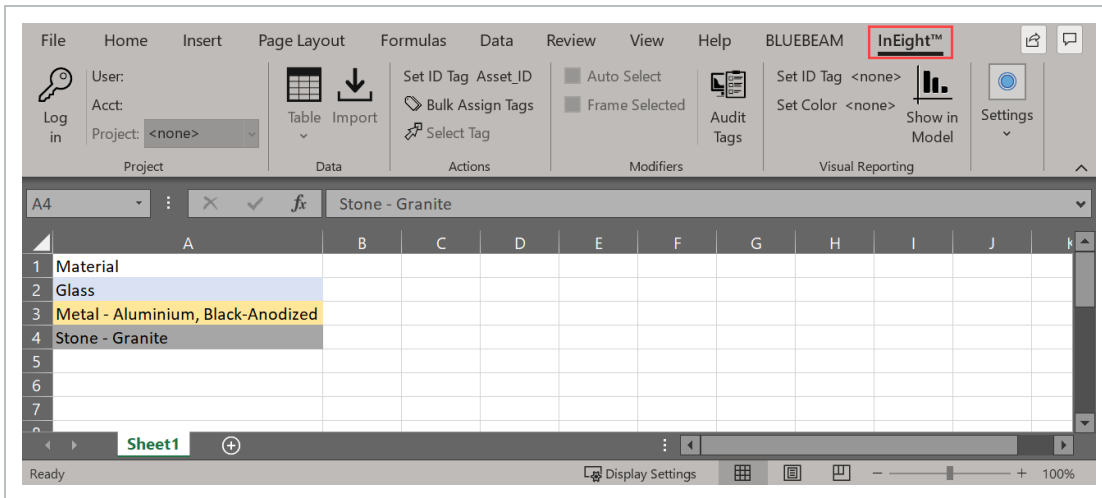

3. Within the Visual Reporting section:

- **Set ID Tag:** click on a cell within the Tag Category, then select **Set ID Tag**.
- **Set Color:** click on a cell that has the color identified, then select **Set Color**.

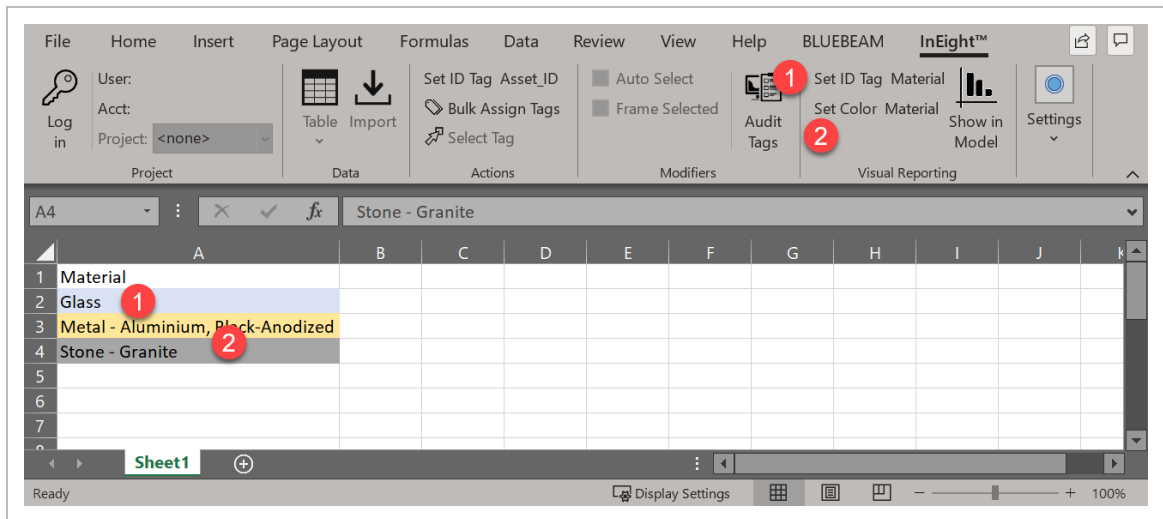

4. In this case, the Set ID Tag and Set Color happen to be in the same column of Material. To push these colors into the model and create a new style set, select **Show in Model**.

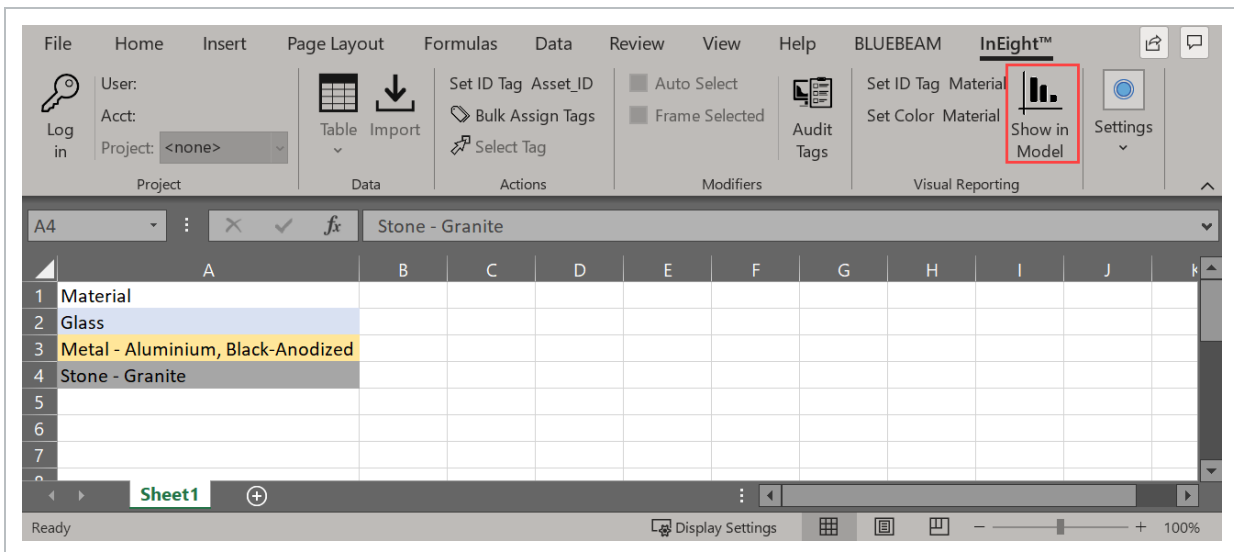

- Your project in Model will reflect the colors selected for those objects. Once Show in Model is executed, a new style set is created within the Styles Sets tab under Visual Reports

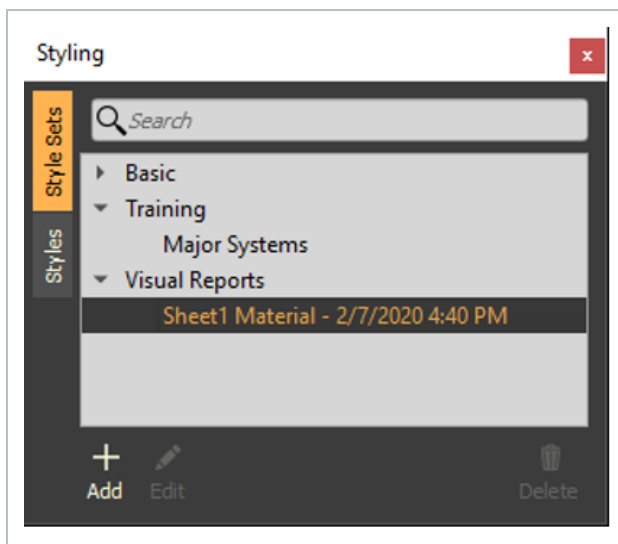

NOTE This style will not be saved with the project in this state.

5. To save this style set with the project, right click on the style set and select **Duplicate Selected Style Set**.

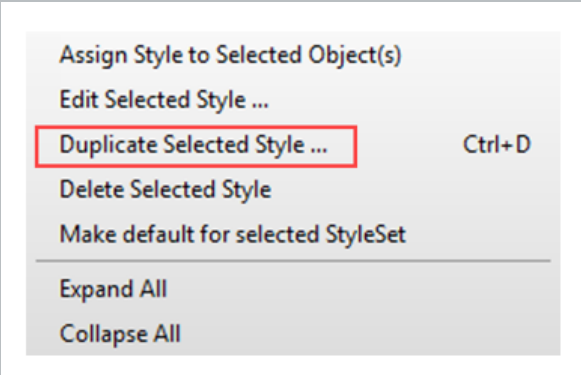

- This new Style Set will appear under the project name

NOTE All model objects that were not affected by the defined color receive a transparency.

2.6 STYLE LEGEND

The Style legend option provides visibility into the color definitions applied to the geometry. You can easily communicate the information to all project stakeholders.

You can open the Styling legend in View > **Style Legend**.

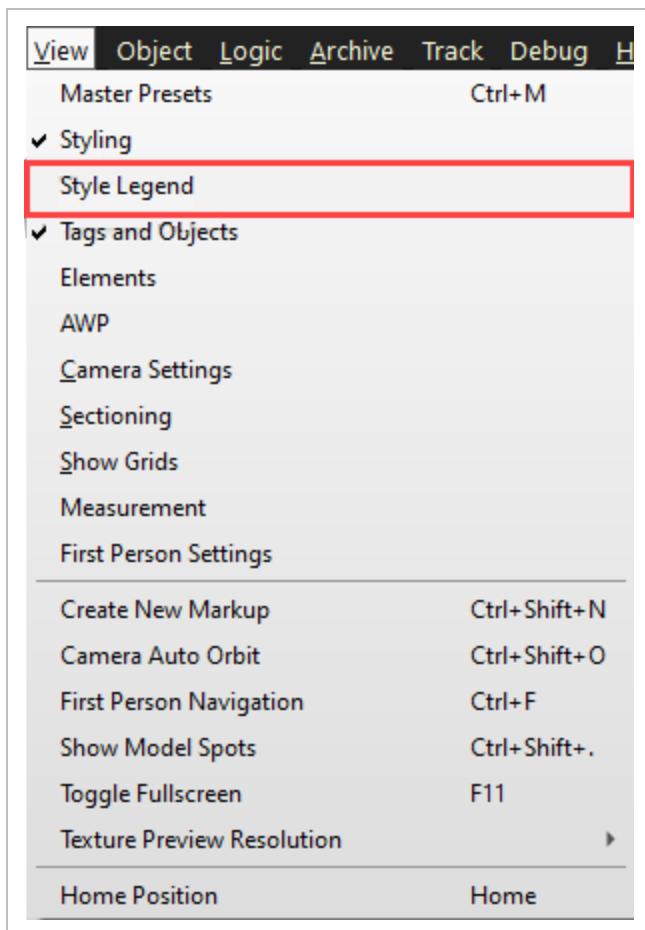

The Style Legend window opens and shows the style name, tag name, and tag value associations that are included in the selected style set.

Style Legend

Active Style Set: RidgeGate Campus

Style	Style Name	Tag Name	Tag Value
	concrete-01_preview	Material Name - CAD	03 30 00_Concrete_Cast-in-Place
Yellow	Yellow	Material Name - CAD	ADA
	Black Oxide Steel_preview	Material Name - CAD	Black Metal
	Black Oxide Steel_preview	Material Name - CAD	Black Metal - Corrugated
	Black Oxide Steel_preview	Material Name - CAD	Black Metal - Flat
	maxwoodCherry4_wCoatings_preview	Material Name - CAD	Casework
	Clearance	Material Name - CAD	Clearance
	concrete-19_preview	Material Name - CAD	Concrete
	concrete_scratched_preview	Material Name - CAD	Concrete - Cast-in-Place Concrete
	pavement_sidewalk_preview	Material Name - CAD	Concrete (Standard)
	concrete-19_preview	Material Name - CAD	Concrete TYP 2
	concrete_scratched_preview	Material Name - CAD	Concrete, Cast-in-Place gray
	concrete-01_preview	Material Name - CAD	Concrete, Precast
	Rough dirty metal_preview	Material Name - CAD	Duct Fittings
	Rough dirty metal_preview	Material Name - CAD	Duct Insulations
	browntowel_preview	Material Name - CAD	Earth
	blue_l_metal_preview	Material Name - CAD	Electrical Equipment
	cyan_l_metal_preview	Material Name - CAD	Electrical Fixtures
	Glass - Transparent	Material Name - CAD	Glass
	Glass - Transparent	Material Name - CAD	Glass - Clear
	Glass - Transparent	Material Name - CAD	Glass - Frosted
	Glass - Transparent	Material Name - CAD	Glass - Spandrel
	Glass - Transparent	Material Name - CAD	Glass Screen
	blackmetal_preview	Material Name - CAD	Haworth - Plastic - Black

The window automatically refreshes after you make a change to the active style set.

A selected Percent complete style set shows the percent complete for each element style color.

This provides the visibility of the status of each element, so you have the data to plan accordingly.

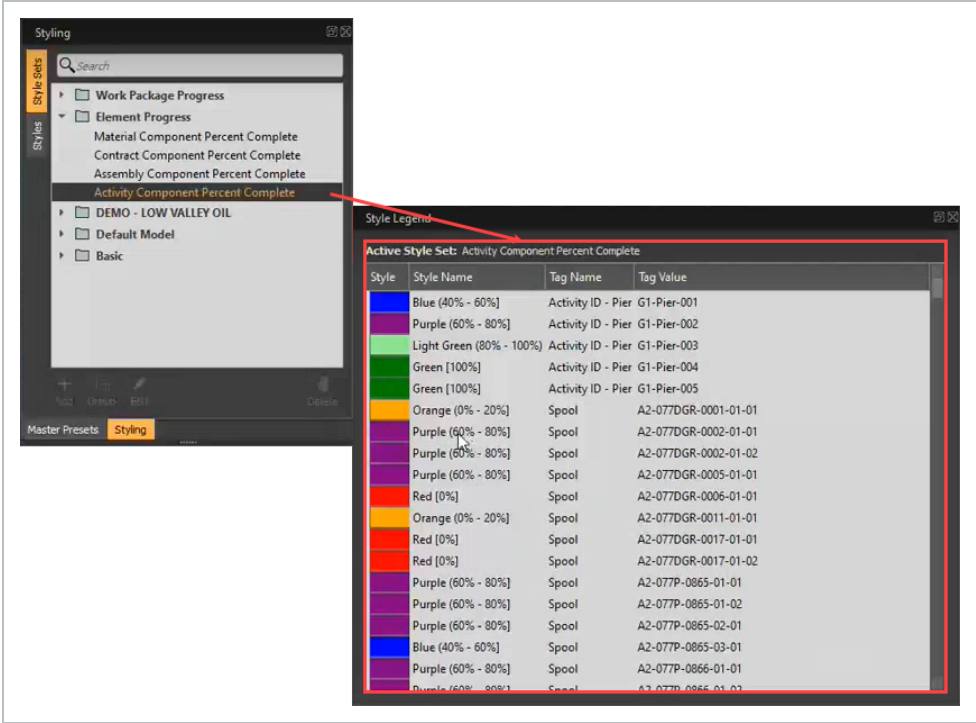

LESSON 2 REVIEW

1. InEight Model offers basic, pre-defined styles.
 - a. True
 - b. False

2. When creating a new style, what two features can you set?
 - a. Line color, fill color
 - b. Fill color, shadow
 - c. Shadow, line color
 - d. None of the above

3. You can only apply a style at the project level.
 - a. True
 - b. False

LESSON 2 SUMMARY

As a result of this lesson, you can:

- Create and manage styles
- Create and manage style sets
- Apply styles to tags
- Assign styles using Excel

This page intentionally left blank.

CHAPTER 3 – MASTER PRESETS

3.1 MASTER PRESETS OVERVIEW

Create a master preset to capture and save the context or state of your project through a filtered lens or camera angle. Navigate between master presets to help you effectively manage your model and share your perspective with other users.

NOTE

Master presets are created on a project level. Once created, anyone can use or edit your master presets.

3.1.1 MASTER PRESET EDITOR

From an open model(s), navigate to the view that you want to save as a master preset. When ready to capture that viewpoint, navigate to **View** and select **Master Presets**. Then, select **Add** and select your preset preferences.

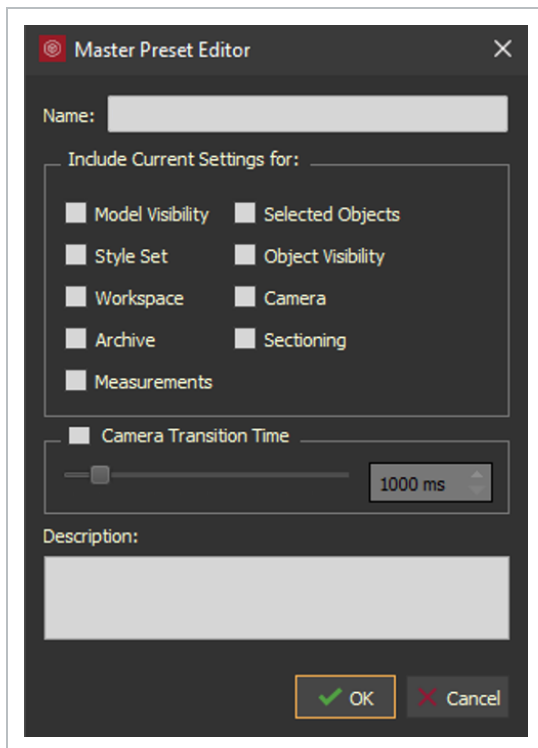

- **Model Visibility** shows models that are visible and in-view

NOTE

Once selected, Model Visibility will not show any new model streams that may be added to the project. To set or adjust model visibility settings, open the Object panel or right click menu to view the show/hide and selection options.

- **Selected Objects** shows any objects you have selected on the model
- **Style Set** shows any styles already assigned to the visible objects of your model
- **Object Visibility** saves the objects' states so that any objects already hidden remain hidden
- **Workspace** saves the user interface configuration, their location, and current screen resolution

NOTE

Selecting Workspace may cause undesirable results for users with different screen resolutions and configurations. Avoid selecting the Workspace when working in a shared preset.

TIP

When a custom Workspace is necessary, create and label a folder in your master preset panel where you can save that preset. Add your Workspace selection (and parameters, if possible) to the master preset description.

- **Camera** saves the current camera settings (i.e. the camera's position in space, direction, and depth of view)
- **Archive** saves any open documents in the Archive Library

TIP

Using Archive, you can bookmark pages within a document so that users open to a specific page while viewing the project from your master preset.

- **Sectioning** shows any planes or sections of your model(s) that are visible
- **Measurements** shows selected measurements graphically or visually
- **Camera Transition Time**, with the Camera option selected, allows you to adjust the speed of the camera's transition time. The default Camera Transition Time is 1,000 milliseconds

NOTE

If Camera is not selected, you cannot adjust the Camera Transition Time.

3.1.2 RESET WORKSPACE

If a master preset has messed up your workspace, you can reset your workspace by going to the Settings and selecting **Reset Workspace**.

3.1.3 RIGHT CLICK MENU FEATURES

Quickly access additional master preset options by right clicking within the Master Preset panel.

- **Edit and Update Selected ...** opens the Master Preset Editor so you can quickly make and save changes to a preset for the selected assets
- **Update Select w/ Current Values** updates a Master Preset with the current model view configuration without opening the Master Preset Editor
- **Set as Project Default** will make the selected master preset the default view (of the project you have open) anytime you load that project
- **Copy URL to Clipboard** copies the master preset of your project to share with other collaborators
- **Delete Selected** deletes any selected master preset(s)
- **Add Group ...** allows you to add a group from the right click menu
- **Rename Group ...** allows you to rename a group from the right click menu
- **Delete Group** deletes any selected group(s)
- **Expand All** shows all folders in the master preset panel
- **Collapse All** collapses all folders in the master preset panel
- **Export as Viewpoints** allows you to create an XML file that you can import into Navisworks. In other words, you can share your viewpoint (including any presets you have, the order of those presets, and your spatial view of the model) with others through Navisworks

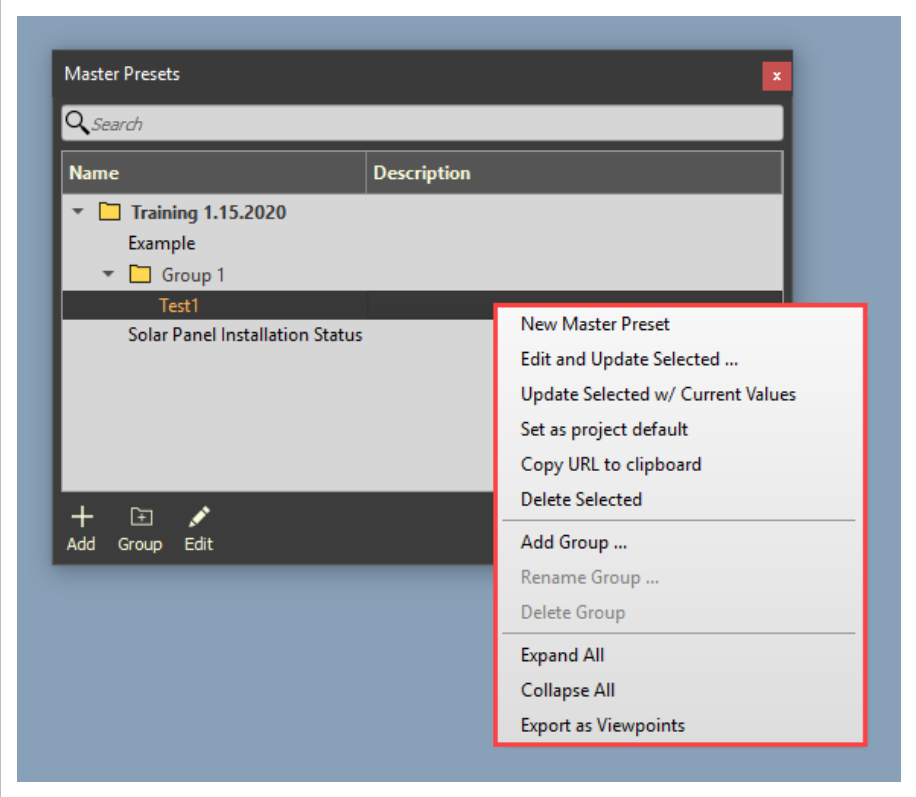

3.2 CREATE AND MANAGE MASTER PRESETS

3.2 STEP BY STEP 1 – CREATING A MASTER PRESET

1. Select **Add** to create a new preset.

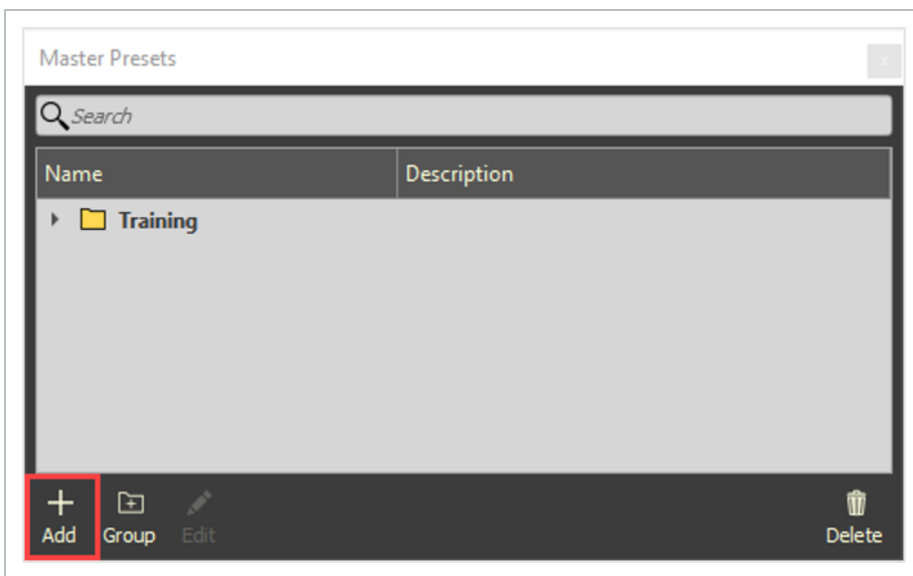

- The Master Preset Editor will open

2. Name your master preset.

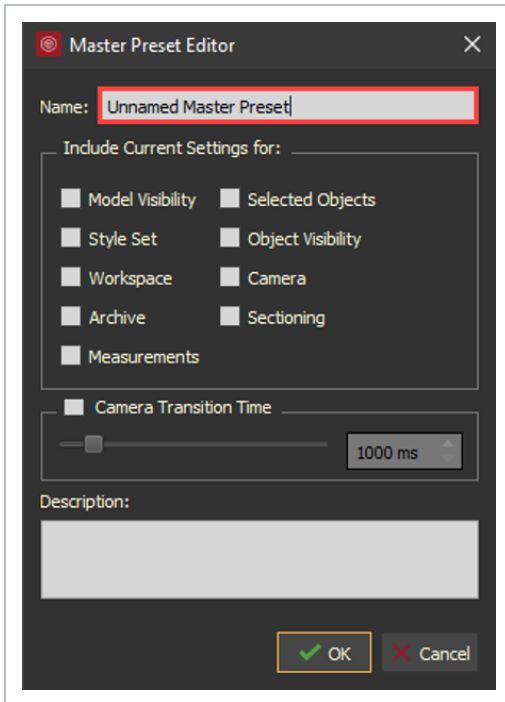
**TIP**

It is good practice to create one or more HOME master presets.

3. Next, check the filter selections you would like to apply to this preset.

TIP

Mouse over settings for tool tips.

4. Add a description to help others who use this preset to know what view of the project they are seeing and why (optional).
5. When finished, select **OK**.

NOTE

The description text does not wrap, so it is best practice to keep the description short.

3.2.1 MASTER PRESET OBJECT VISIBILITY MAXIMUM DIALOG BOX

This is a rare notification that you could encounter when you are trying to Hide Unselected while you are also selecting the Object Visibility option when creating the Master Preset.

You can also get that dialog box if you published one entire model from Navisworks.

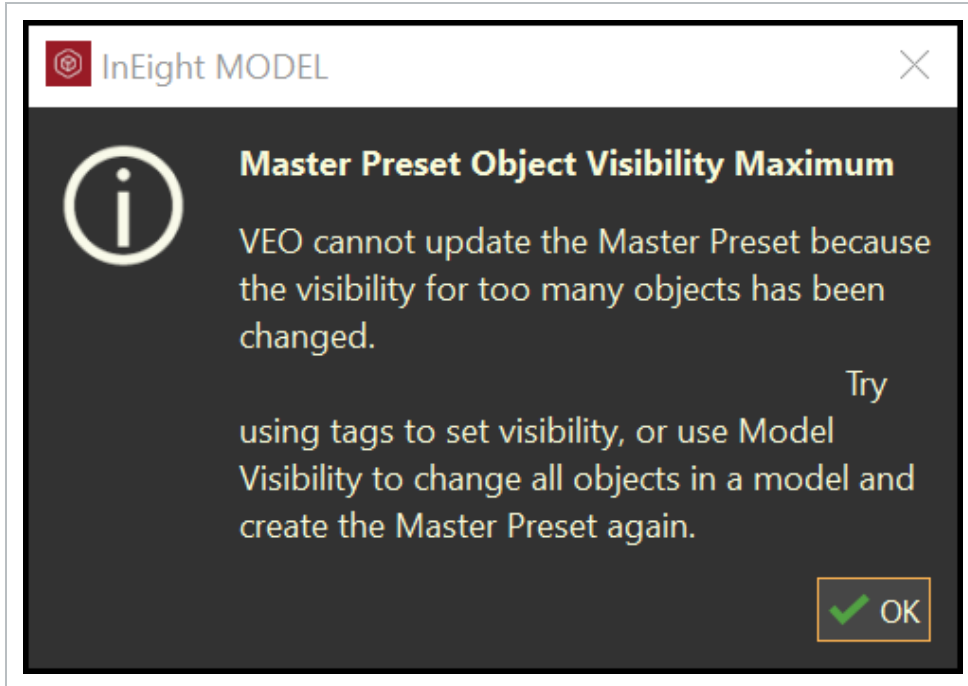

It is recommended that you publish discipline specific models or area specific models. Then select objects, RMC, and select Hide Models from Unselected. Then RMC and select Hide Unselected. After that, create the Master Preset with Object Visibility option.

3.2 STEP BY STEP 2 – EDITING A MASTER PRESET

1. Select the master preset that you want to modify and select the **Edit** icon.

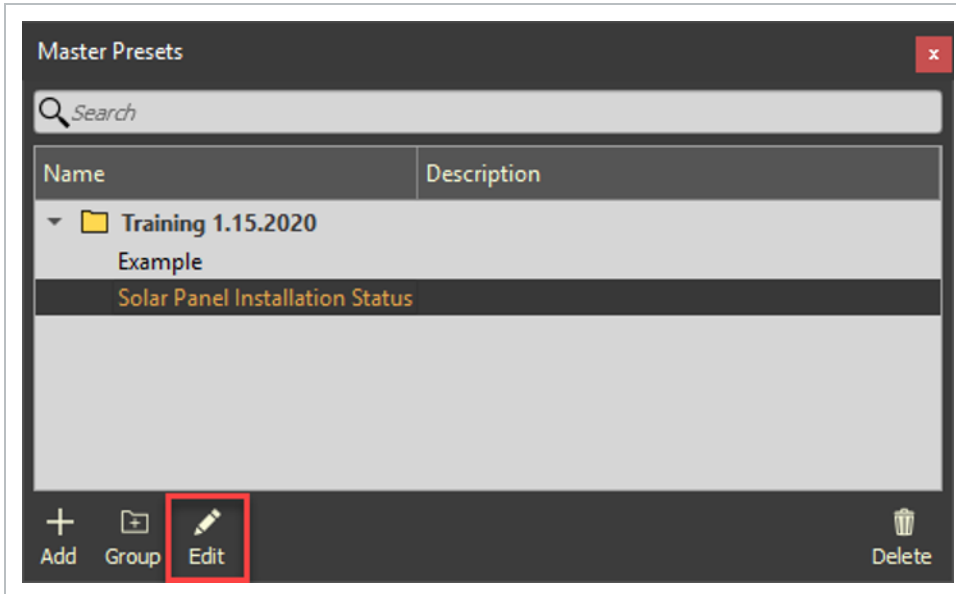

- The Master Preset editor will open

2. Make your changes and select **OK**.

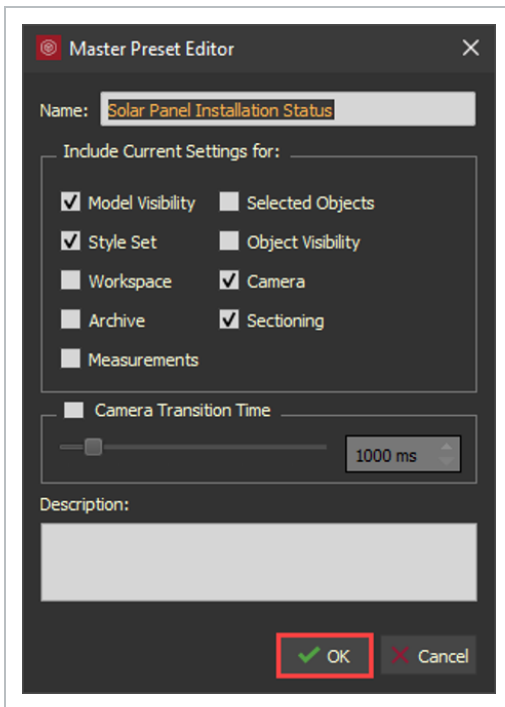

3.2 STEP BY STEP 3 – EDITING A MASTER PRESET - MODEL VIEW

1. Prepare your model view.
2. Select a master preset and click the **Edit** icon. Then, select **OK**.
 - Or, right click on a master preset, then select **Update Selected w/Current**

Settings

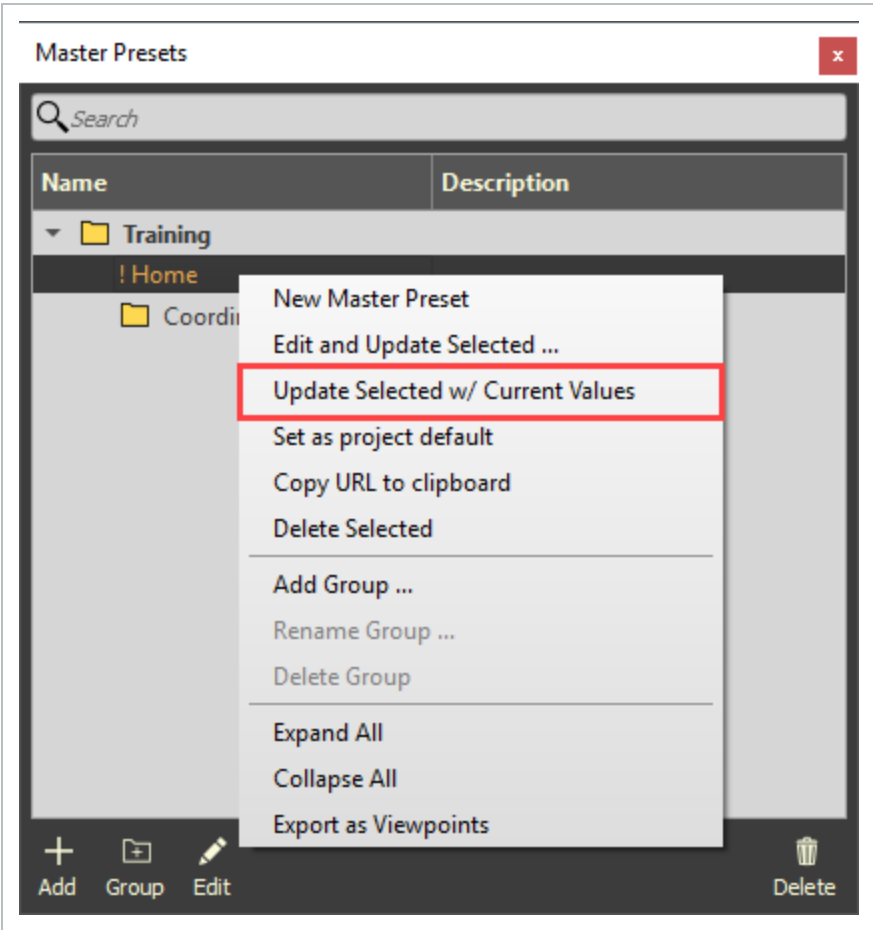

3.2 STEP BY STEP 4 – DELETING A MASTER PRESET

1. Select the master preset that you want to remove and select the **Delete** icon.

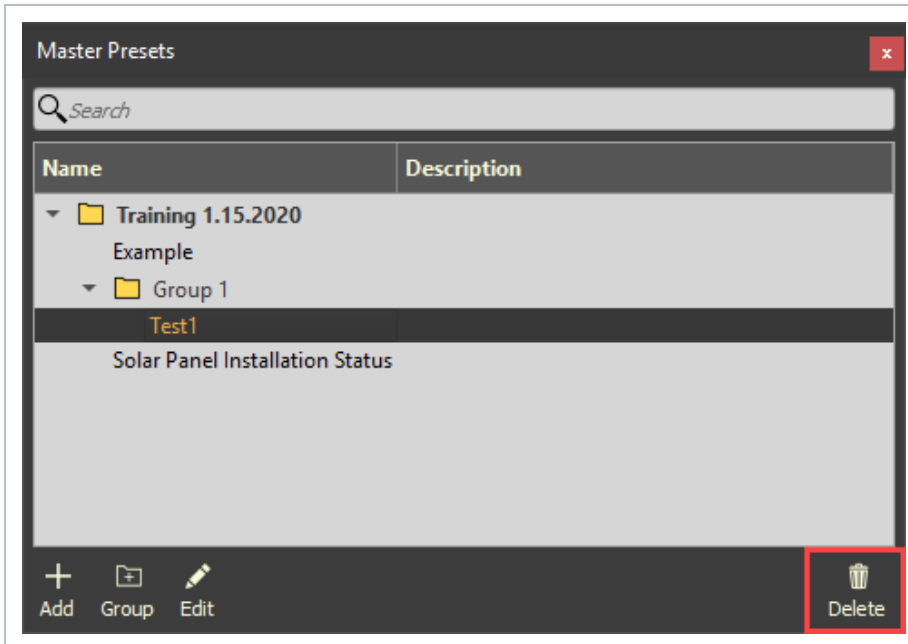

3.3 ORGANIZE MASTER PRESETS

Organize master presets into contextual groups to distinguish between executive-level, task-specific, team-specific views. Drag and drop master presets and groups within the Master Preset panel to create comprehensive organization.

3.3 STEP BY STEP 1 – GROUPING MASTER PRESETS

1. Select the **Group icon** and enter a group name. Then select **OK**.

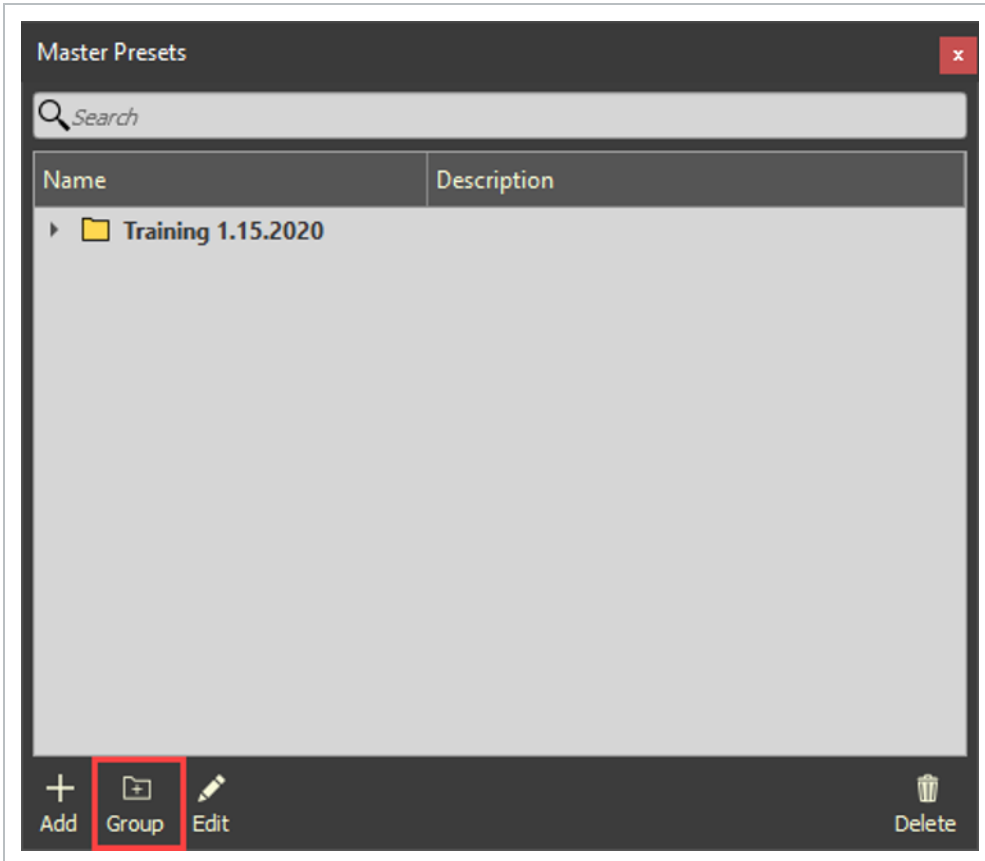

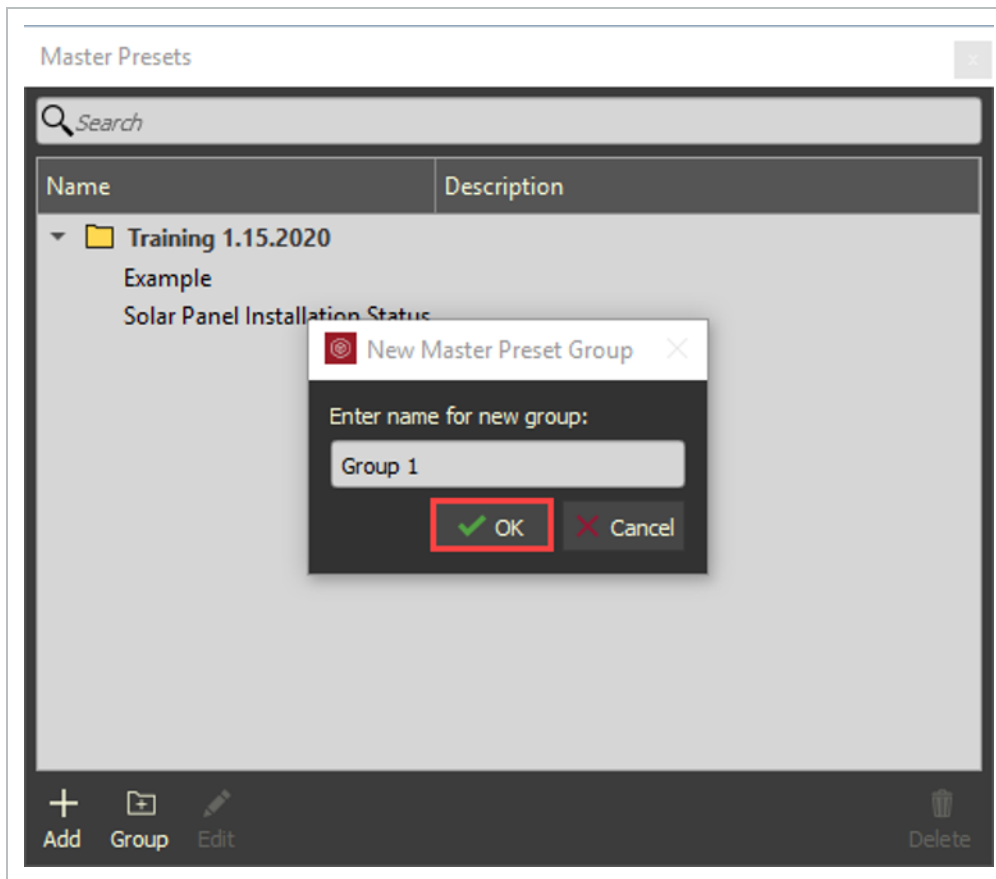

2. Now, you can add presets to this group.

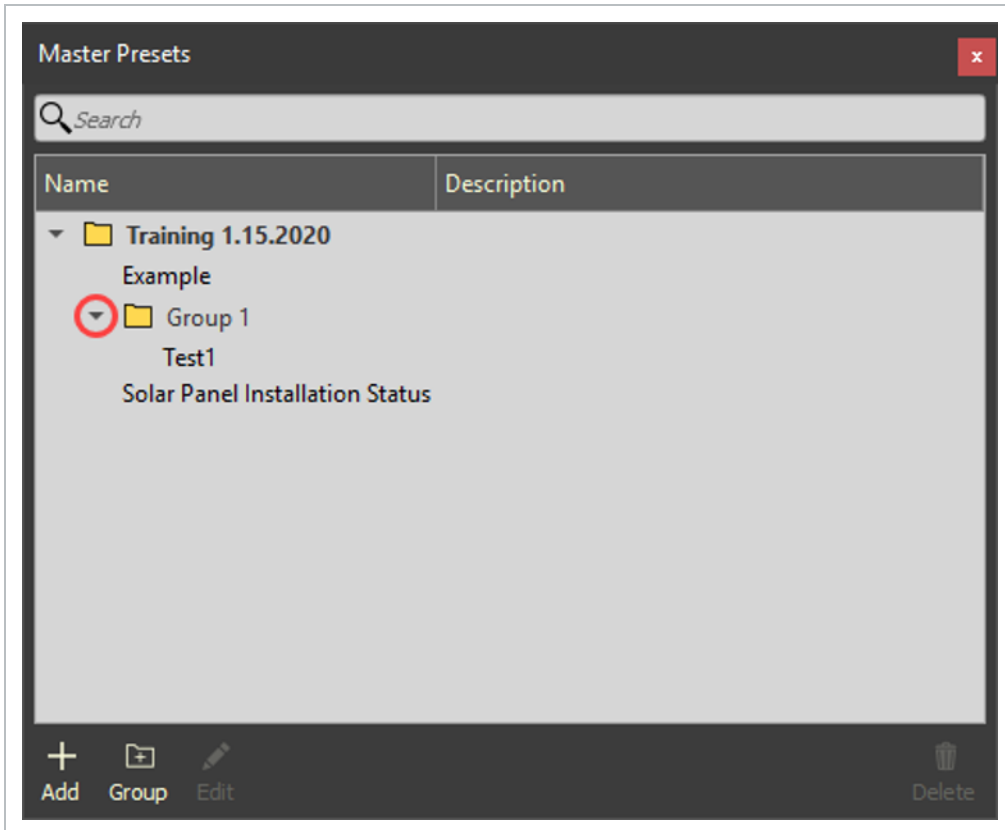
**NOTE**

Notice, you cannot drag and drop a group above the project name. That's because groups are created under the parent project.

3.3 STEP BY STEP 2 – SET A MASTER PRESET AS THE PROJECT DEFAULT

A master preset can be set as the project default so that when a project loads the model view is set to the default master preset.

1. Right click on a master preset, then select **Set as project default**.

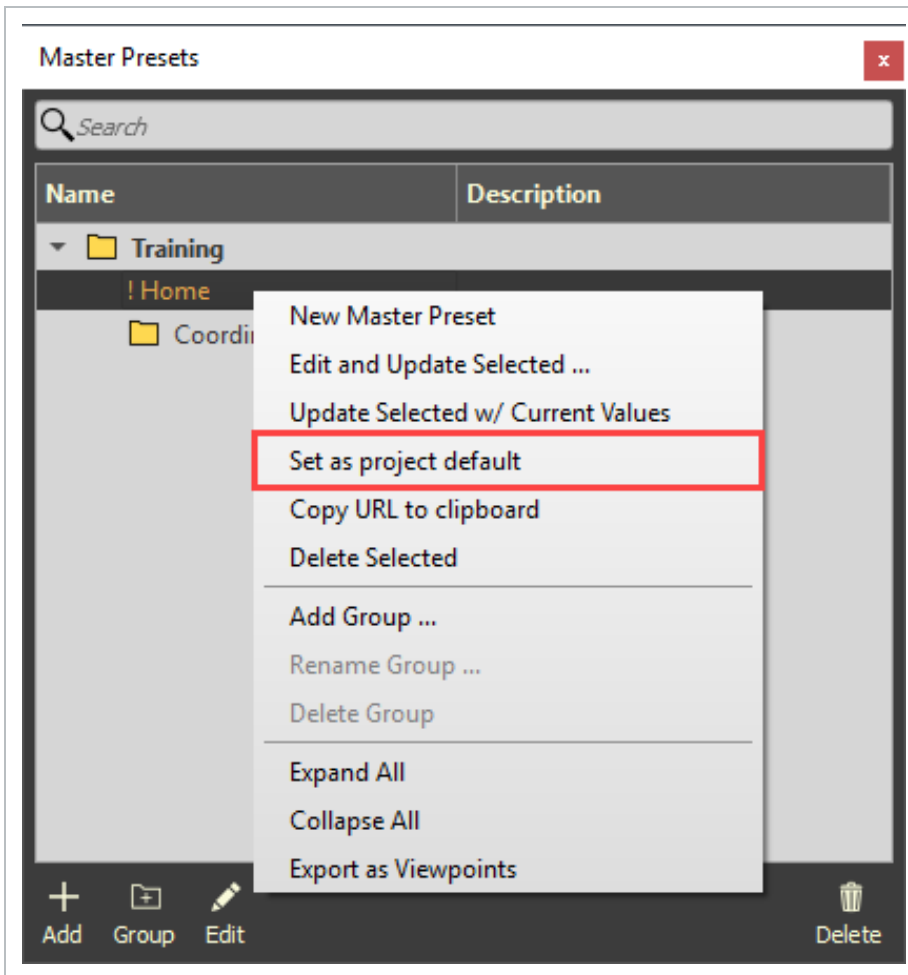

3.4 SHARE AND EXPORT MASTER PRESETS

Quickly communicate by sharing a master preset with other project collaborators. Add emphasis or clarity by assigning colorful style sets and tags to your master preset. Or, use master presets to check project progress or review changes by comparing the captured viewpoint against its archived state in the Project History folder (View > Project History).

3.4 STEP BY STEP 1 – SHARING A MASTER PRESET

1. Select and right click on the master preset that you want to share. Select **Copy URL to Clipboard**.

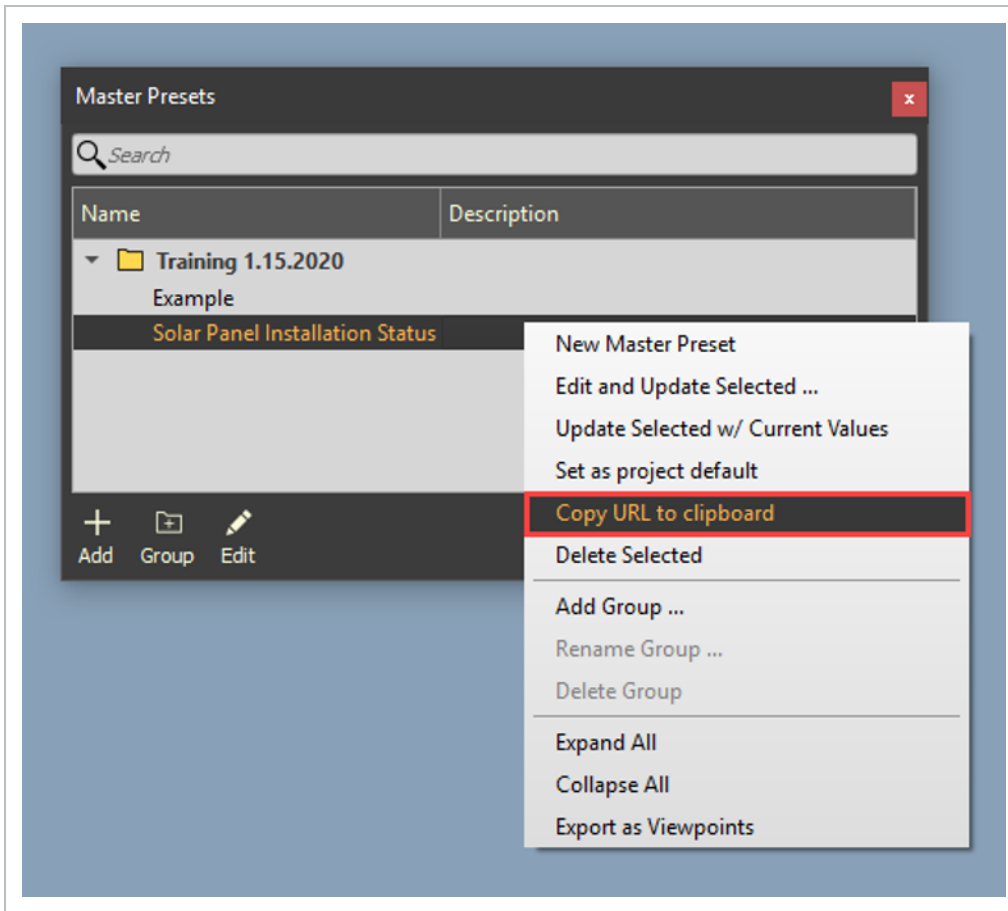

- You can now paste your preset URL to an email, message, or other means of communication.

3.4 STEP BY STEP 2 – EXPORTING MASTER PRESETS

1. Right click on a master preset, then select **Export as Viewpoints**.

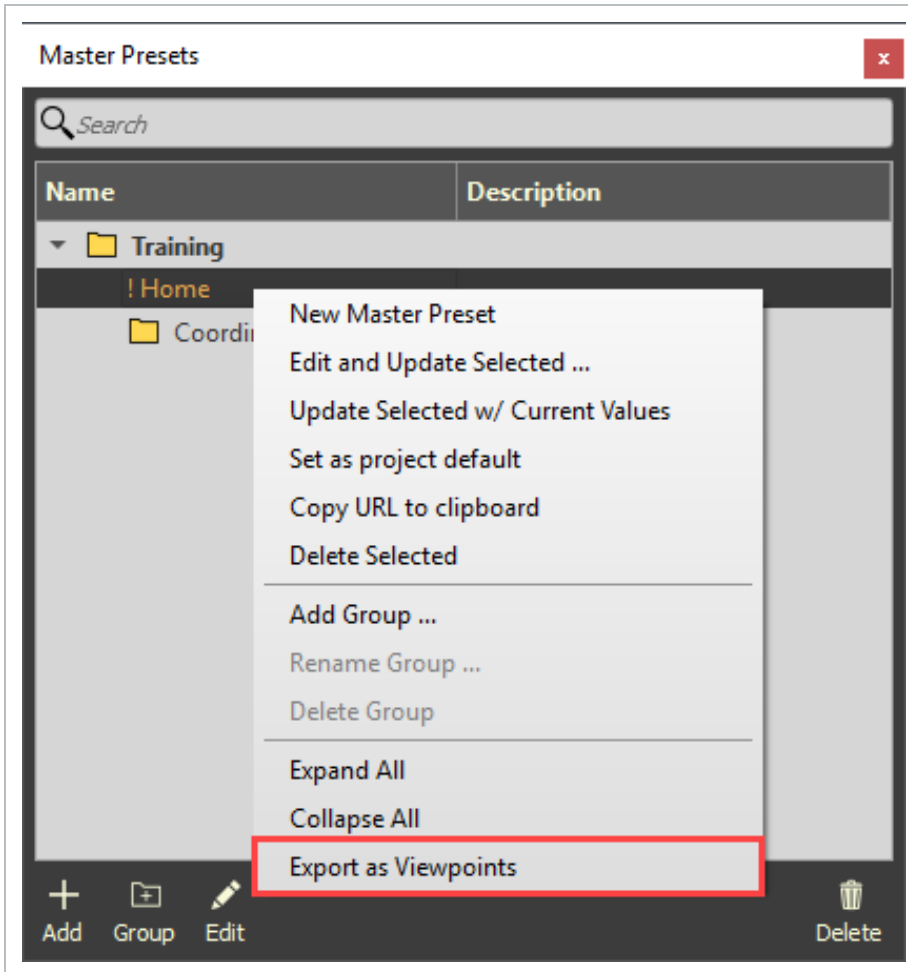

LESSON 3 REVIEW

1. Master presets can help you to...
 - a. configure a custom workspace.
 - b. create profiles or filters of your model to convey specific information.
 - c. All of the above
 - d. None of the above

2. From the Master Preset Editor, selecting _____ will show any planes of your model that are visible.
 - a. Measurements
 - b. Sectioning
 - c. Archive
 - d. Model Visibility

3. Only project administrators can group or share presets.
 - a. True
 - b. False

LESSON 3 SUMMARY

- Create and edit master presets
- Group master presets
- Share master presets

This page intentionally left blank.

CHAPTER 4 – COORDINATION - CLASH MANAGER

4.1 CLASH MANAGER OVERVIEW

Coordination is the process of using rules to identify hard and soft clashes, creating grouped clashes into trackable issues, and assigning them to users or user groups to resolve.

Clash Manager rules are flexible rules established to detect clashes between model objects by examining geometric relationships between tags. Clash manager rule groups can be created to organize rules and to quickly execute multiple rules at the same time.

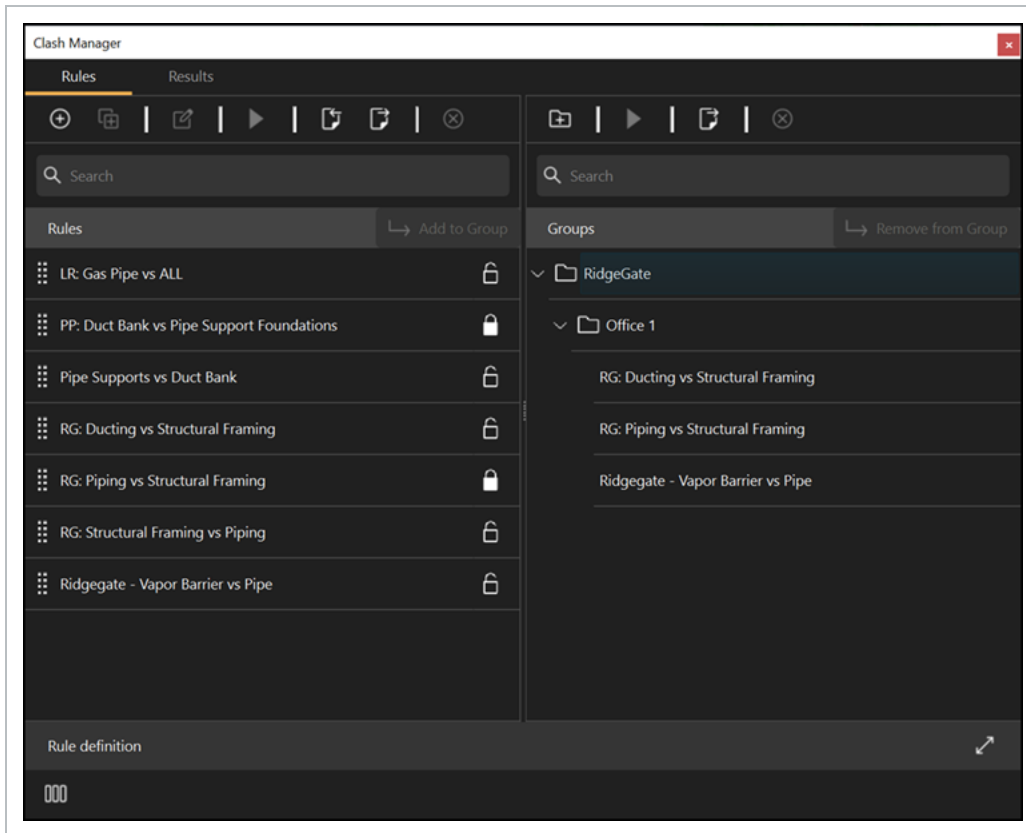

The Clash Manager results tab shows the clashes detected after running a rule.

Name	Count	Select Tag Name
RG: Piping vs Structural Framing	619 clashes	
> Pipe Fittings	2 clashes	
> Pipe Fittings	2 clashes	
> Pipe Fittings	2 clashes	
> Pipe Fittings	1 clashes	
> Pipe Fittings	1 clashes	
> Pipe Fittings Standard 2#1498507	1 clashes	
> Pipe Fittings Standard 2#1547901	1 clashes	
> Pipe Fittings Standard 2#1559628	1 clashes	
> Pipe Fittings Standard 2#1579820	2 clashes	
> Pipe Fittings Standard 2#1579854	2 clashes	
> Pipe Fittings Standard 2#1580386	2 clashes	
> Pipe Fittings Standard 2#1581546	2 clashes	
> Pipe Fittings Standard 2#1583221	1 clashes	
> Pipe Fittings Standard 2#1583347	2 clashes	

4.2 CREATE AND MANAGE COORDINATION RULES

Coordination rules are triggers from tags. In Clash Manager, rules are created to fine-tune the workload and the focus of the coordination.

A best practice is to create discipline focused rules. For example, when you clash piping/plumbing versus steel, then make the piping/plumbing your primary tag and steel your secondary tag. This type of rule groups related steel clashes to a single piping/plumbing clash.

4.2.1 CONSIDERATIONS

Admin and Standard users can create coordination rules. Read-only users can also create coordination rules but cannot save any actions to the project.

Rules that are linked to issues are locked and cannot be modified.

4.2.2 STEPS

To open the Clash manager, go to Logic > **Clash Manager**.

CREATE A COORDINATION RULE

1. In the Rules tab, click the **Add** icon. The Rule definition dialog box shows.
2. Enter a name in the **Title** field.
3. Select a **Primary Tag Name** and **Primary Tag Value**.
4. Select a **Secondary Tag Name** and **Secondary Tag Value**.
5. Add Tolerance Settings as needed. For more information, see [Tolerance Settings](#).
6. Select the **Include Objects From Same Model Stream** checkbox if your primary and secondary tags are within the same model stream.

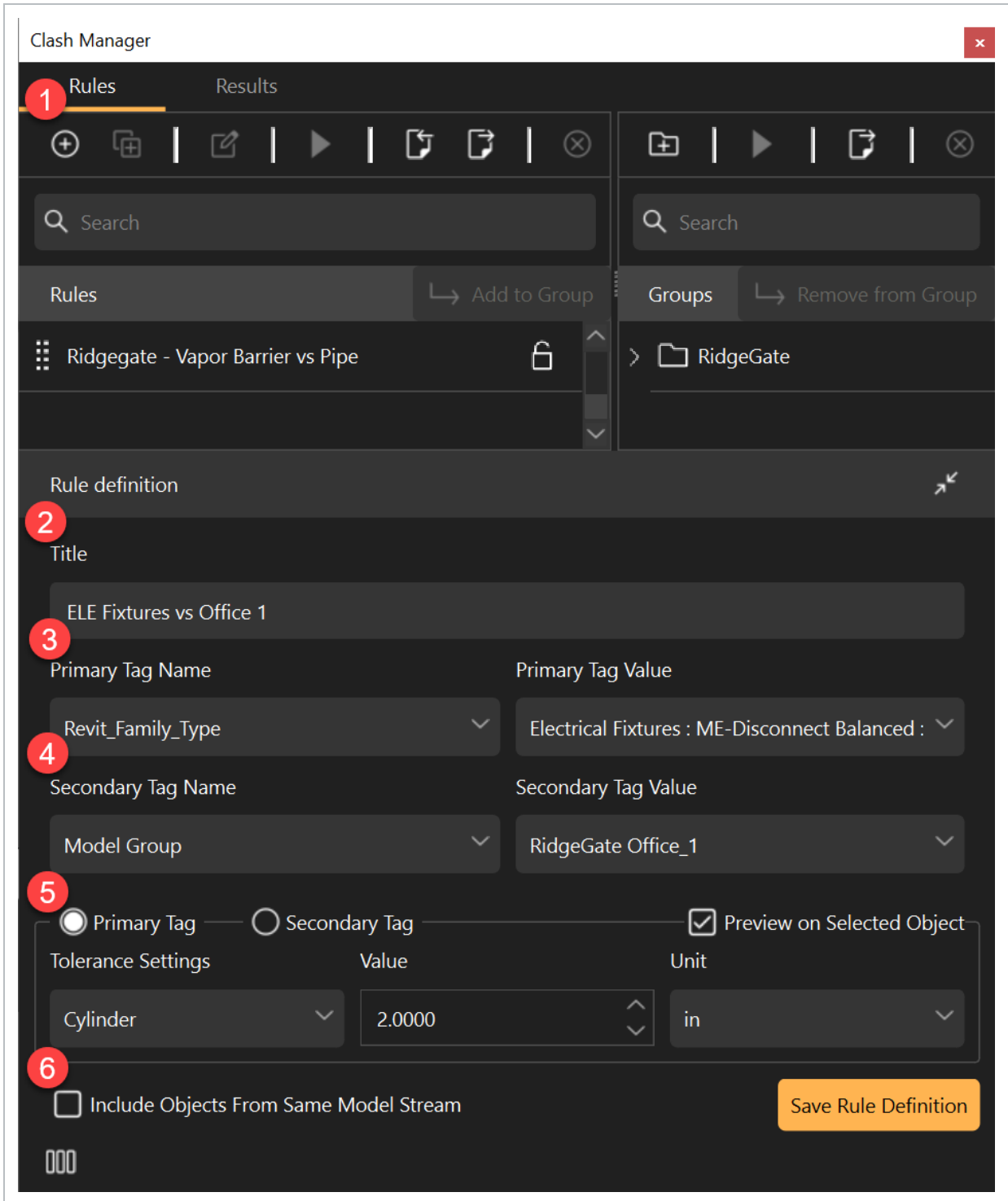

EDIT A COORDINATION RULE

1. Select a rule from the list.
2. Click the **Edit** icon. The Rule definition dialog box opens.
3. Make your rule definition changes in the **Rule Definition** dialog box.
4. Click the **Save Rule Definition** button.

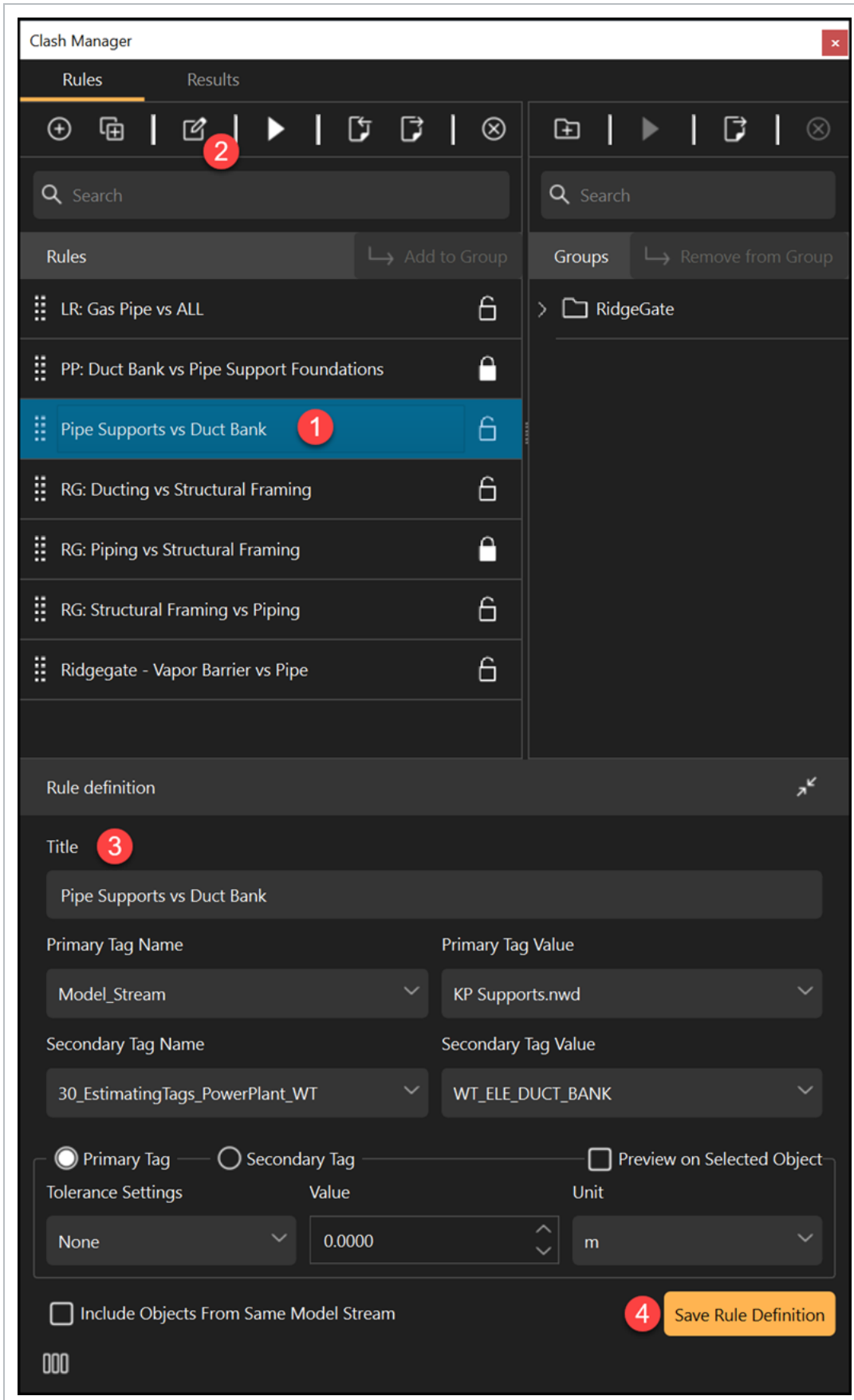

To view the Rules and Results tab side-by-side, click the **Expand** icon at the bottom left of the panel.

EXPORT RULES

1. Click the **Export** icon.
2. Select **Export All Rules...** or **Export Selected Rules...**. The export file is saved in a `.cr` file extension in xml format.

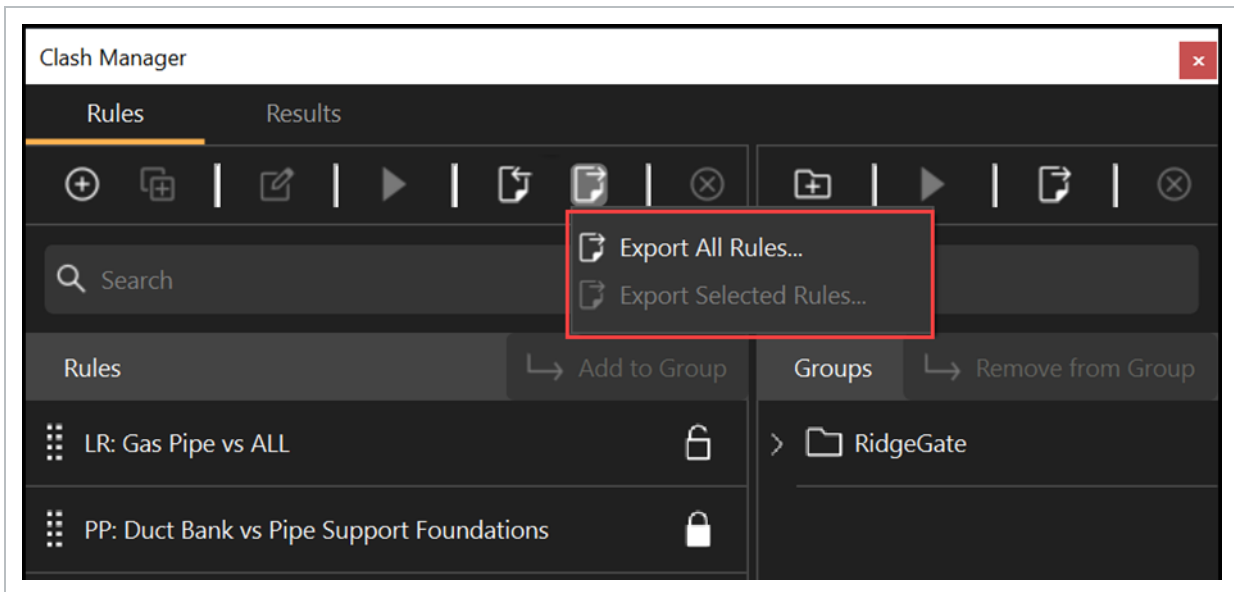

IMPORT RULES

1. Click the **Import** icon.
2. Select the file to import, and then click the **Import** button.

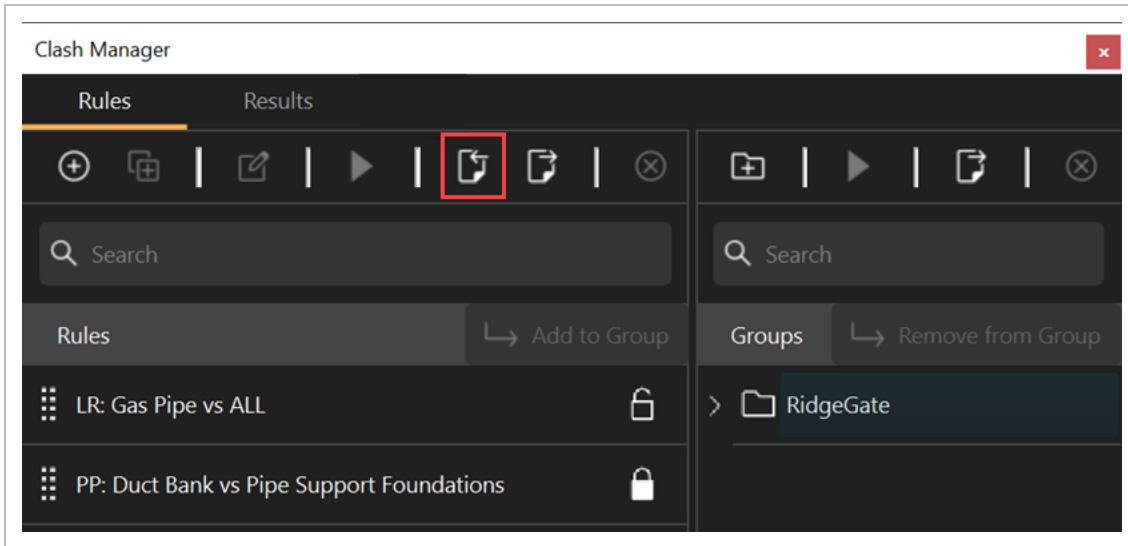

NOTE When importing, the tags identified in the rules are created as tags in the project if they do not already exist.

4.3 TOLERANCE SETTINGS

Tolerance settings are used to define minimum clash tolerances or tolerance zone requirements around objects. You can isolate an object, and then preview the selected object to visualize and experiment with these settings.

The following table is a list of the available tolerance settings:

Setting	Description
None	Used to detect any geometric intersection.
Expand	<p>Expands the geometry in all directions by the defined value.</p> <ul style="list-style-type: none"> Use a negative number to require a minimum Clash Tolerance. Negative a tenth of an inch will require a collision of a tenth of an inch or more before listing it as a Clash. Use a positive number to establish a clearance zone around the object. Positive one foot will list any geometry within a foot of the object as a Clash.
Sphere	Establishes a spherical Clash Tolerance or Clearance Zone.
Cylinder	Establishes a cylindrical Clash Tolerance or Clearance Zone.

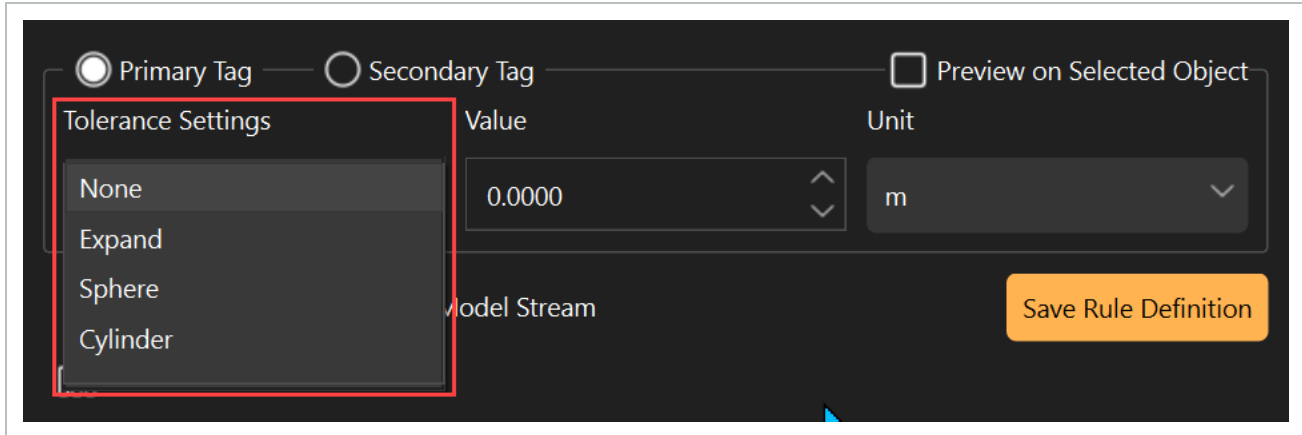

4.3.1 STEPS

NOTE You must first select an object. The object selected represents all objects with the same Primary or Secondary Tag Value selected.

CREATE RULES FOR EXPAND, SPHERE, AND CYLINDER TOLERANCE SETTINGS

1. Fill in the Rule definition fields to create a rule.
2. Select Expand for Tolerance Settings.
3. Select the Preview on Selected Object checkbox.
4. Select a Unit from the drop-down list.
5. Enter a value in the Value field.

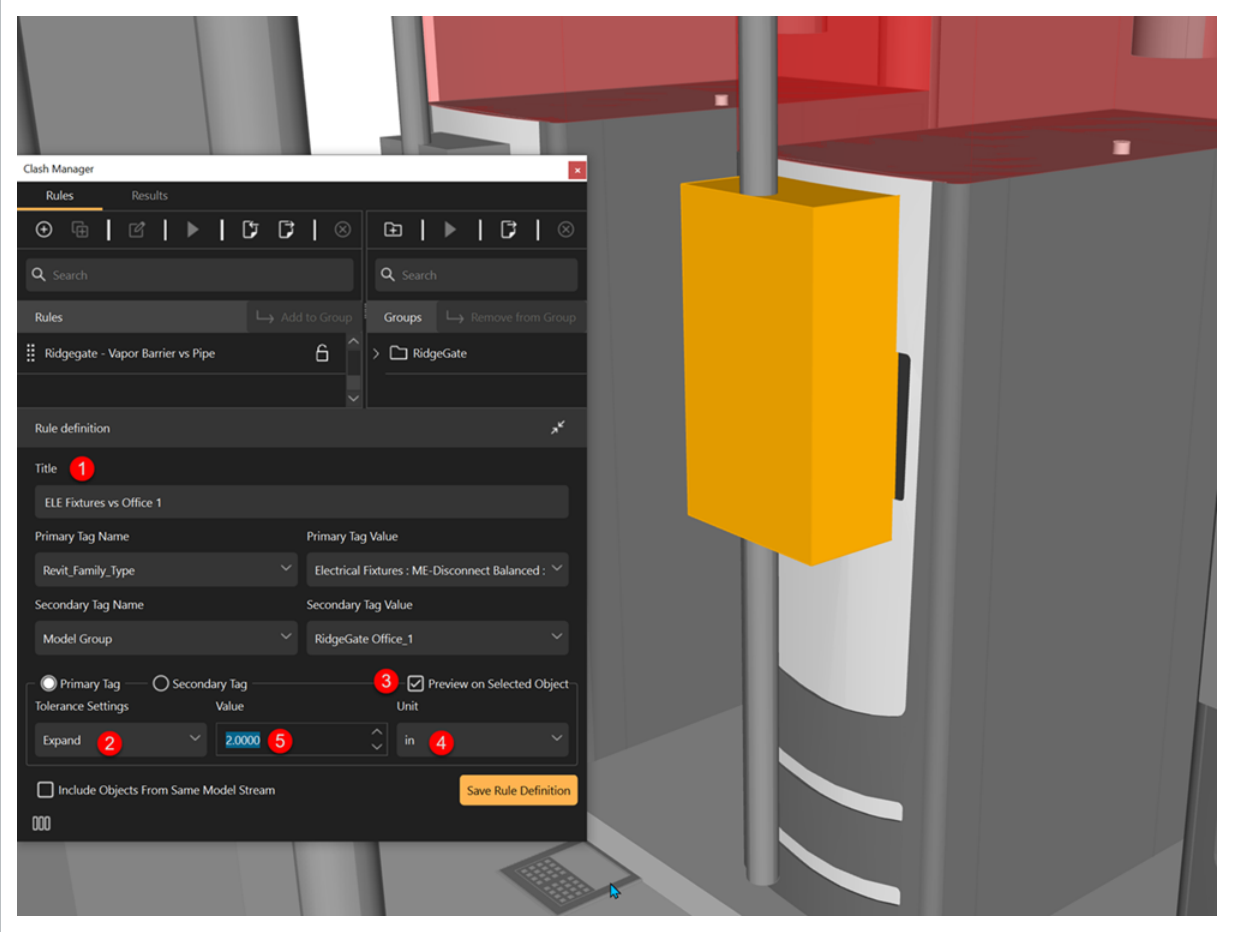

You can follow the same steps for Sphere and Cylinder tolerance settings as shown in the images below:

Sphere

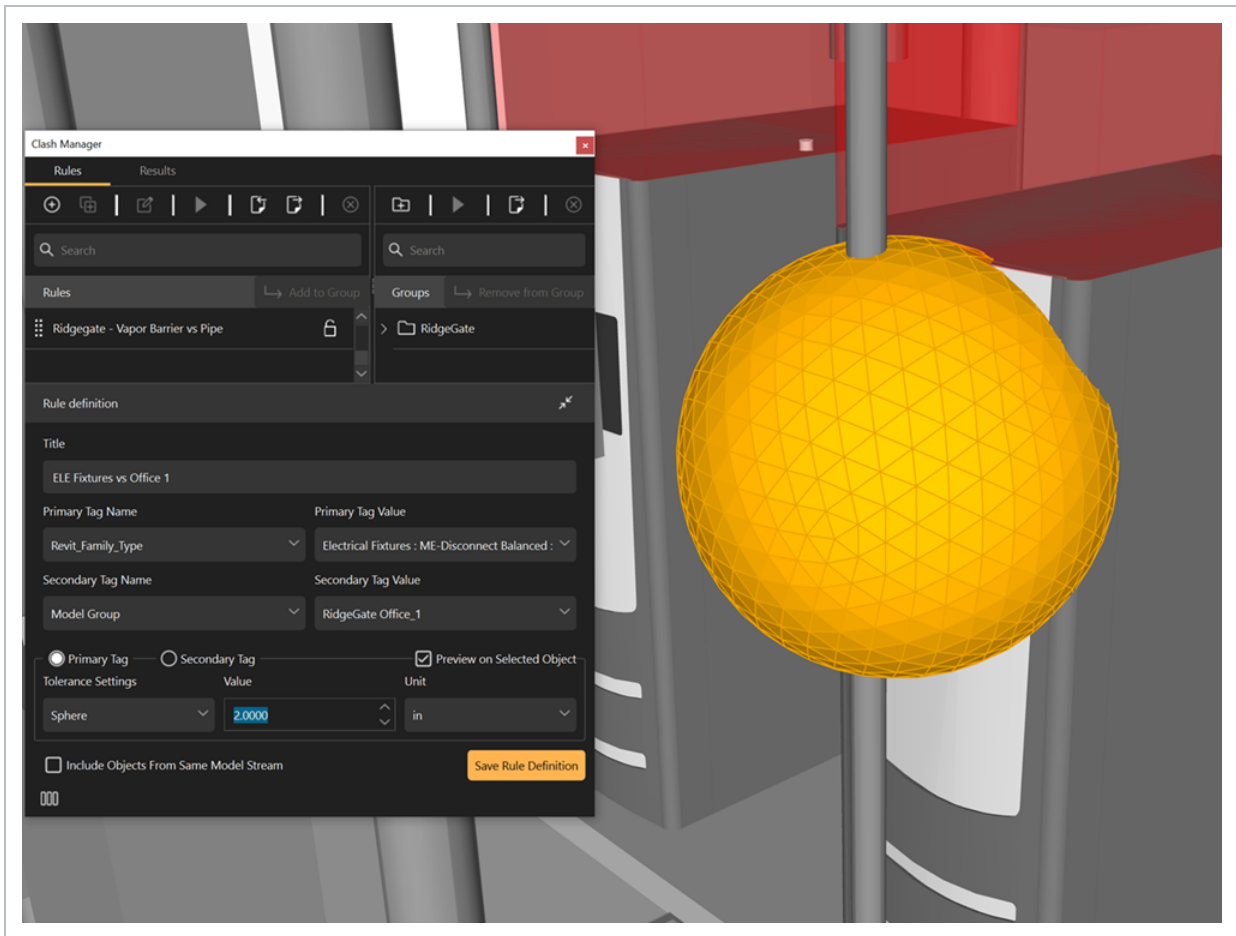

Cylinder

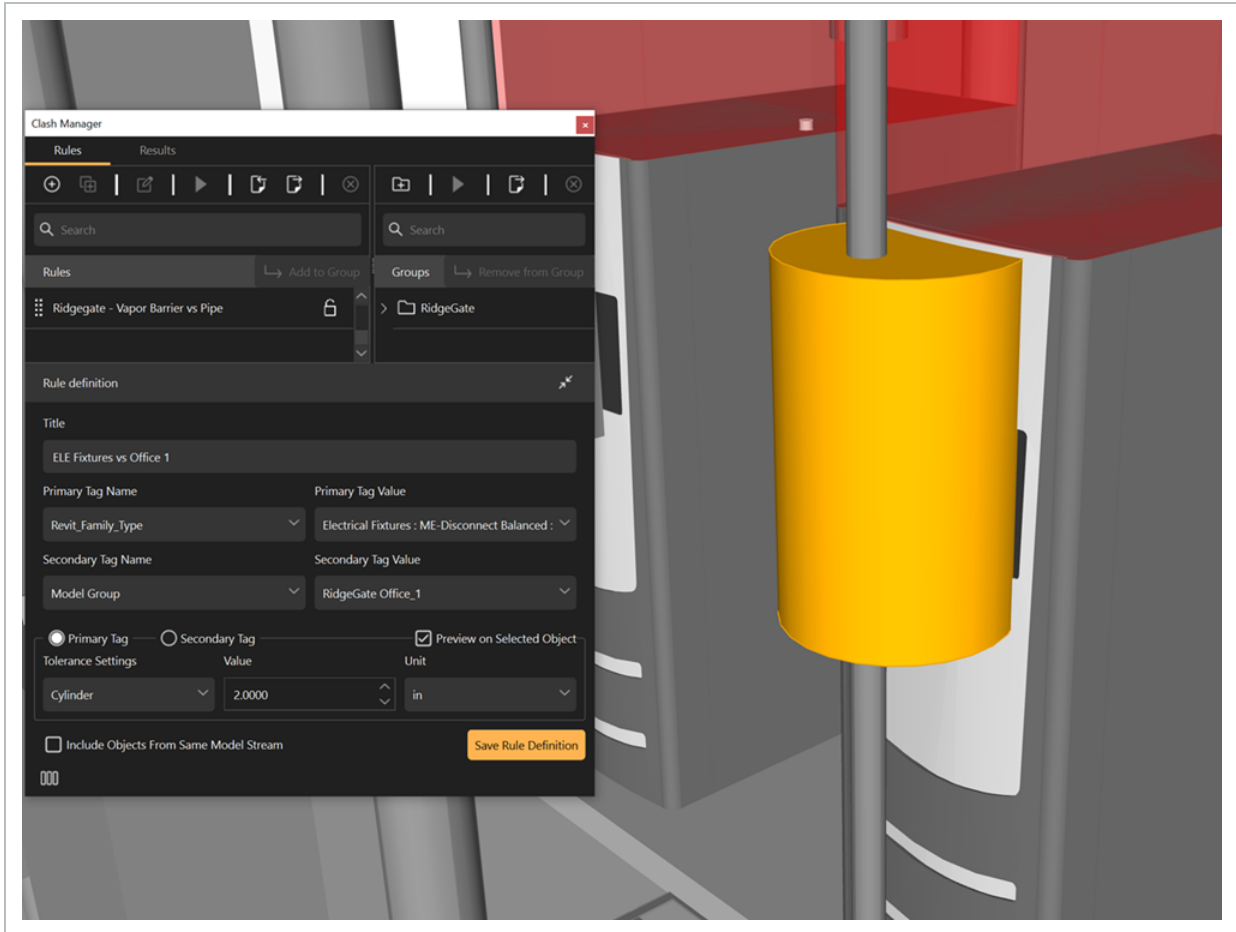

4.4 CREATE AND INTERROGATE CLASH RESULTS

In Clash Manager you can run clash rules or rule groups to get clash results. The clash results can then be reviewed and interrogated. To open Clash Manager, go to Logic > **Clash Manager**.

NOTE A best practice is to use a master preset to focus on a specific area of the federated discipline models before running a rule to review focused clash results.

4.4.1 CONSIDERATIONS

Admin and Standard users can create coordination rules. Read-only users can also create coordination rules but cannot save any actions to the project.

4.4.2 STEPS

CREATE CLASH RESULTS

1. In the Clash Manager Rules tab, select a rule or rule group, and then click the **Run rule** icon.

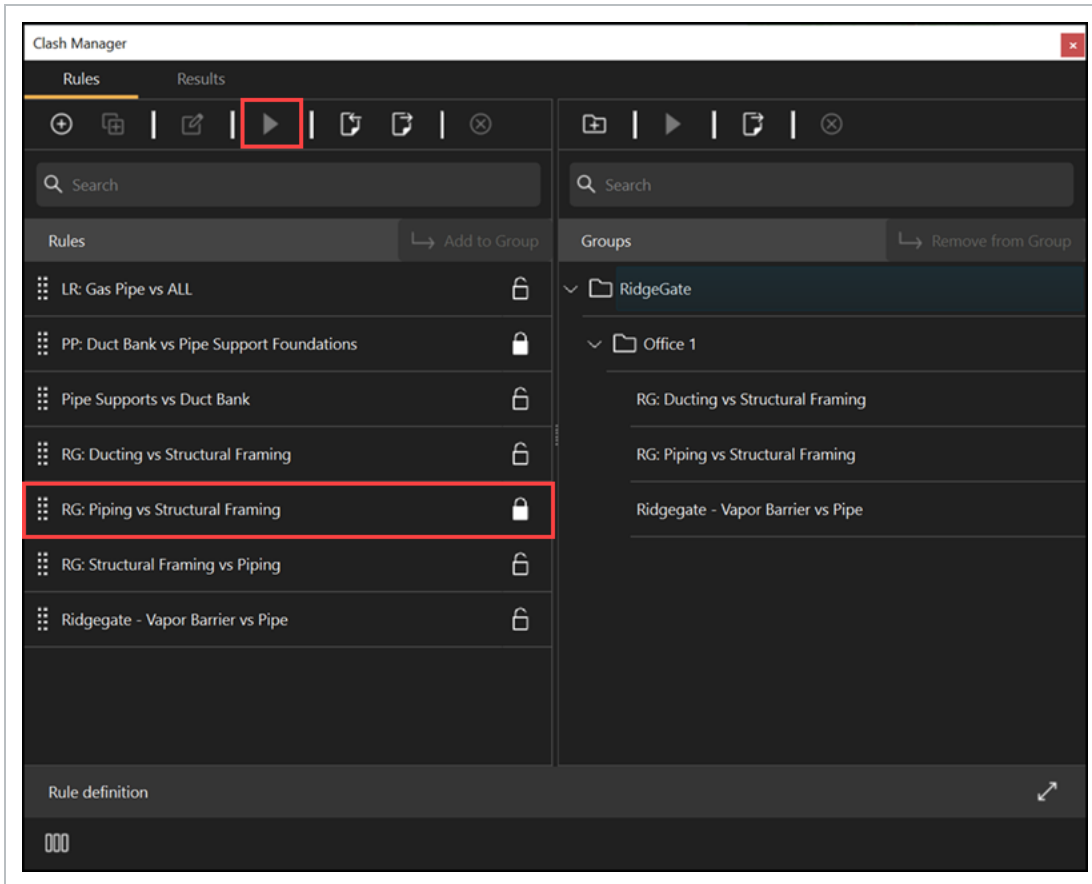

The Results tab will open and show the clash results grouped by the primary tag selected in the rule creation.

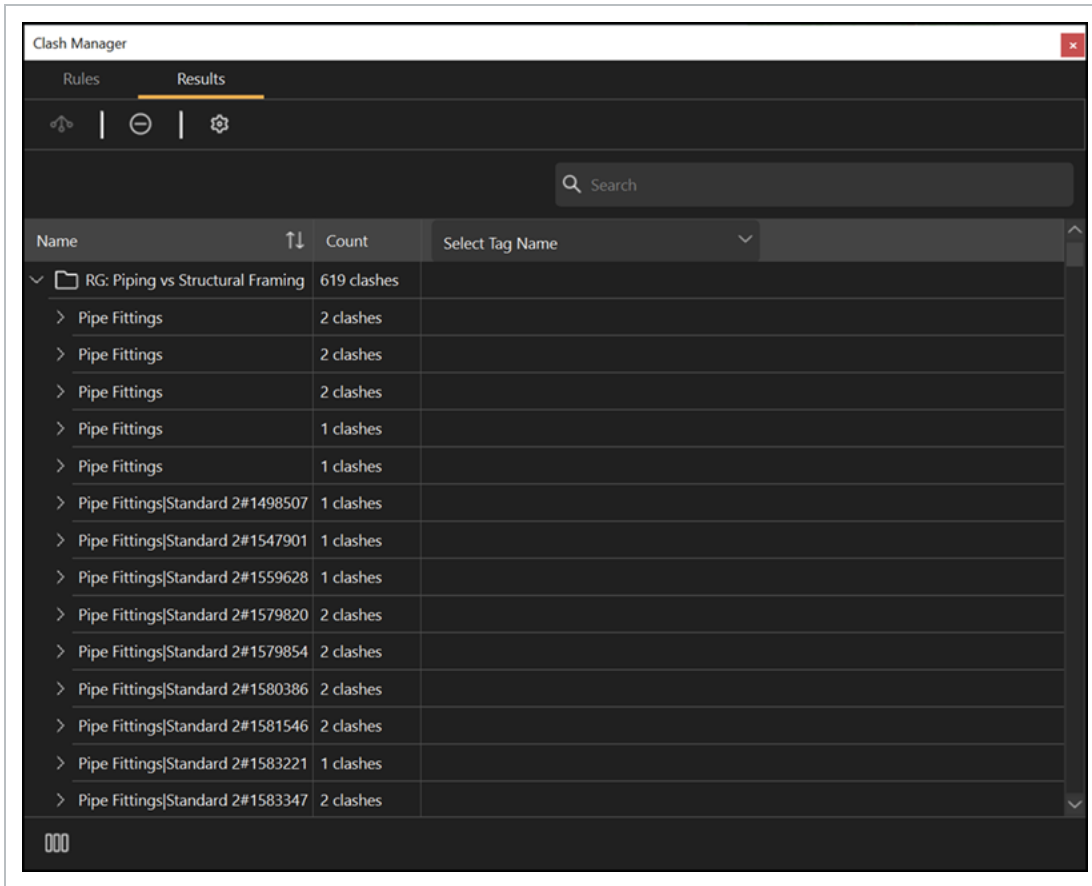

2. In the Results tab, select a clash result, and then select a tag in the **Select Tag Name** drop-down to view additional insight of the clash results.
3. To view a heatmap of results, click the **Clash results settings** icon to enable **Issued Result** and **Clash Points**.

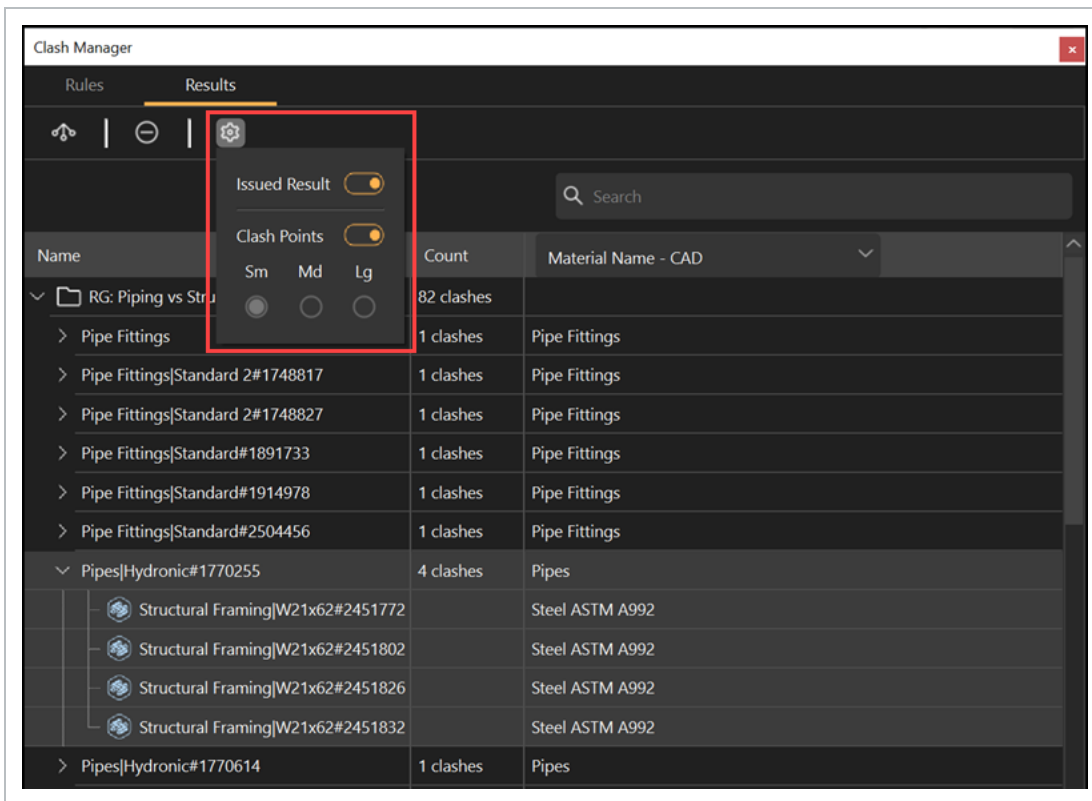

4. Click the **Select all clash results** icon at the top left to group and view additional related clashes to group into a single issue.
5. Click the **Clear the results list** icon to clear and deselect clash results.

To view the Rules and Results tab side-by-side, click the **Expand** icon at the bottom left of the panel.

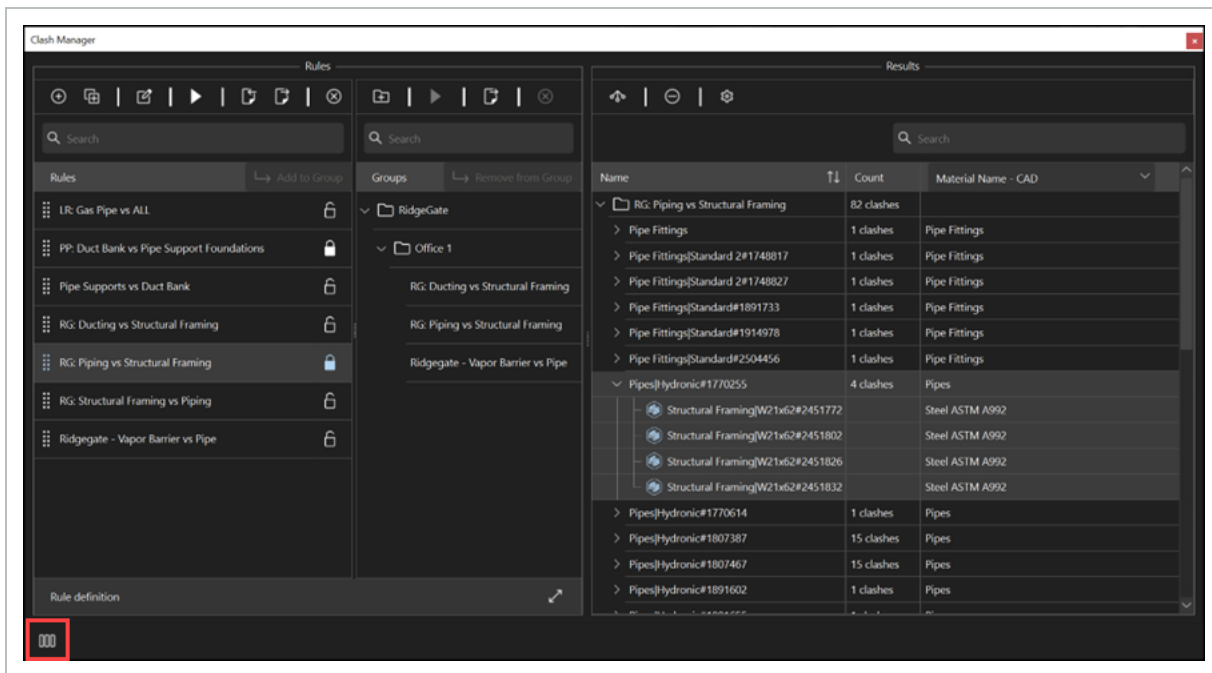

4.5 CREATE AND MANAGE COORDINATION RULE GROUPS

Coordination rules can be run individually or as groups in the Clash Manager Rules panel. Coordination rule groups let you run all rules that are relevant to a scope item at the same time. Rule grouping is helpful when the project's overall scope is divided across the project team.

A best practice is to create discipline focused rules. For example, when you clash piping/plumbing versus steel, then make the piping/plumbing your primary tag and steel your secondary tag. This type of rule groups related steel clashes to a single piping/plumbing clash.

4.5.1 CONSIDERATIONS

Admin and Standard users can create coordination rules. Read-only users can also create coordination rules but cannot save any actions to the project.

4.5.2 STEPS

To open Clash Manager, go to Logic > **Clash Manager**.

CREATE A COORDINATION RULE GROUP

1. In the Rules tab, click the **Add Group** folder icon in the Groups section, and then enter the group name.
2. Click the new group folder, and then click **Add folder** to create a sub-folder.
3. Select one or more rules, select a Group folder, and then click the **Add to Group** button.

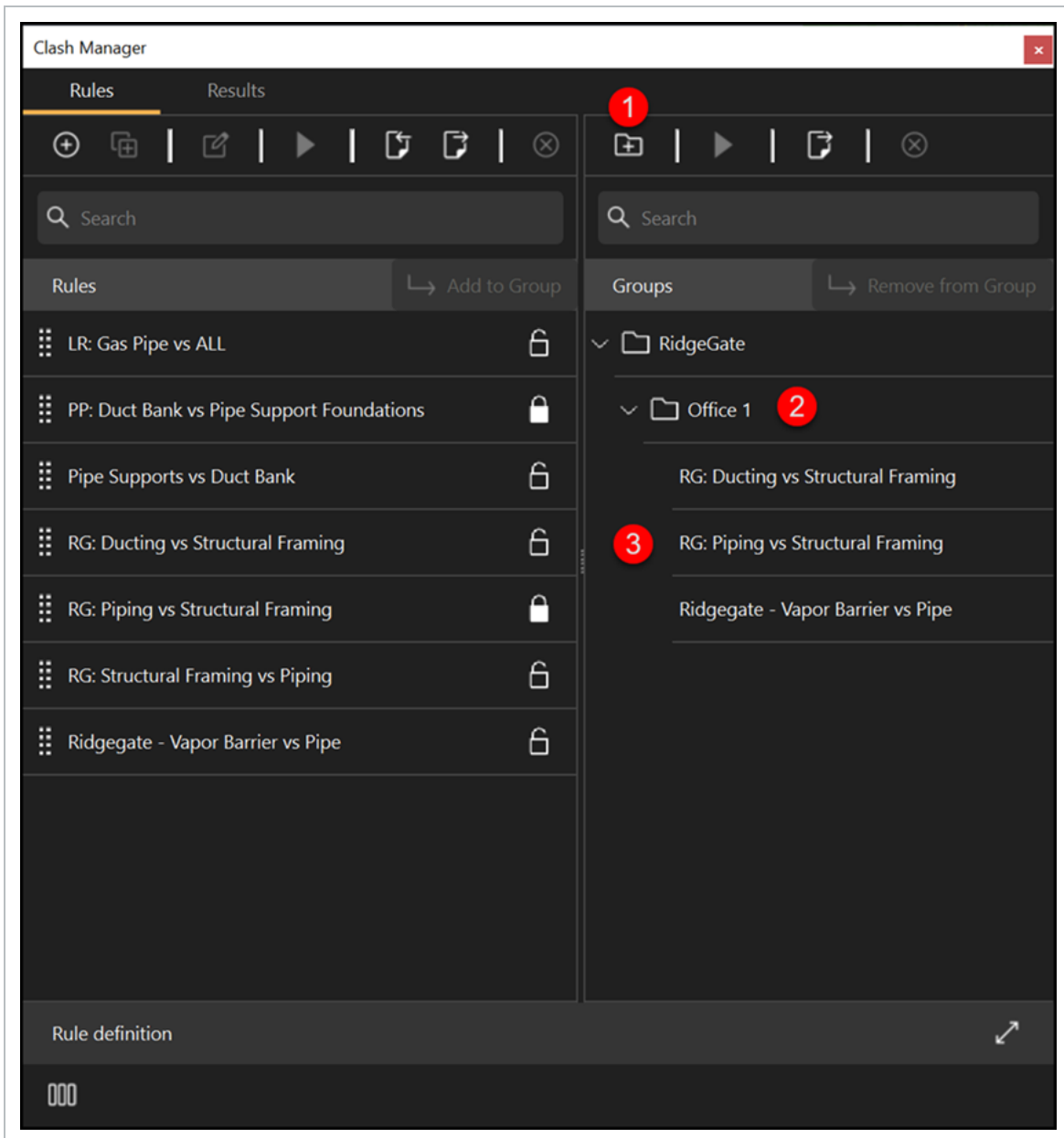

To view the Rules and Results tab side-by-side, click the **Expand** icon at the bottom left of the panel.

EXPORT RULES GROUPS

1. Click the **Export** icon.
2. Select **Export All Groups...** or **Export Selected Groups...**. The export file is saved in a *.cr* file extension in xml format.

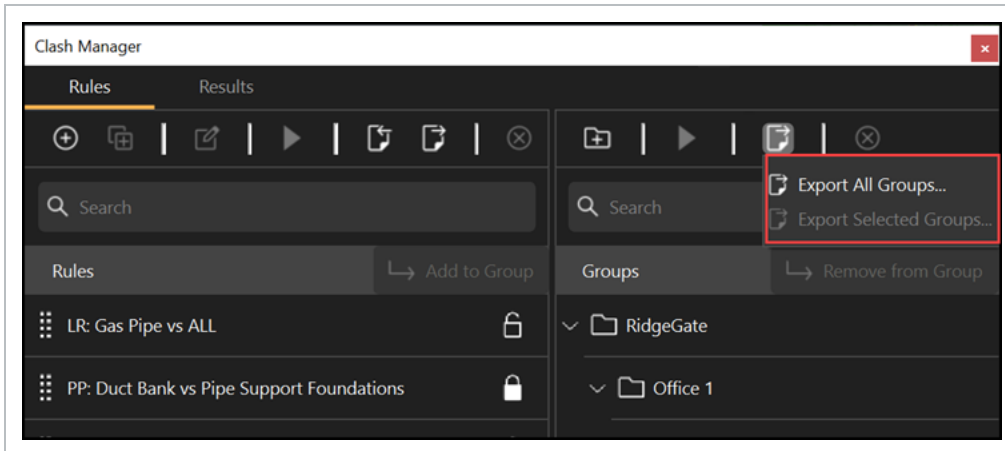

4.6 SHOW DUPLICATE OBJECTS

The Show Duplicate Objects option lets you perform duplicate checking operations in the aggregated Model environment.

Based on the data reported using the show duplicate option, the design team can remove duplicate object geometry from the authoring environment.

To see a list of duplicate objects, run the report in Logic > **Show Duplicate Objects**.

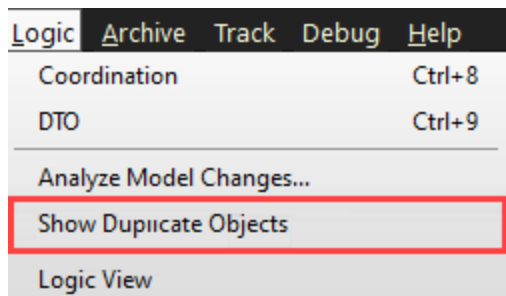

A new window opens that shows grouped duplicate objects and provides the source file information so you can remove the duplicated geometry at the source.

Duplicate Objects				
Group	Source ID	Object Name	Model	InEight Model GUID
1	83cf130e-0e6f-4fa3-b8fa-7b54eaca5e17-00143d39	UHMW, White	INT_OFFICE_2	6d817188-6587-49b7-af76-7dd65728c0d3
1	83cf130e-0e6f-4fa3-b8fa-7b54eaca5e17-00143d39	UHMW, White	INT_OFFICE_2	6d817188-6587-49b7-af76-7dd65728c0d3
2	83cf130e-0e6f-4fa3-b8fa-7b54eaca5e17-00143d3a	UHMW, White	INT_OFFICE_2	6d817188-6587-49b7-af76-7dd65728c0d3
2	83cf130e-0e6f-4fa3-b8fa-7b54eaca5e17-00143d3a	UHMW, White	INT_OFFICE_2	6d817188-6587-49b7-af76-7dd65728c0d3
3	83cf130e-0e6f-4fa3-b8fa-7b54eaca5e17-00143d39	UHMW, White	INT_OFFICE_2	6d817188-6587-49b7-af76-7dd65728c0d3
3	83cf130e-0e6f-4fa3-b8fa-7b54eaca5e17-00143d39	UHMW, White	INT_OFFICE_2	6d817188-6587-49b7-af76-7dd65728c0d3
4	83cf130e-0e6f-4fa3-b8fa-7b54eaca5e17-00143d3a	UHMW, White	INT_OFFICE_2	6d817188-6587-49b7-af76-7dd65728c0d3
4	83cf130e-0e6f-4fa3-b8fa-7b54eaca5e17-00143d3a	UHMW, White	INT_OFFICE_2	6d817188-6587-49b7-af76-7dd65728c0d3
5	83cf130e-0e6f-4fa3-b8fa-7b54eaca5e17-00143d3b	UHMW, White	INT_OFFICE_2	6d817188-6587-49b7-af76-7dd65728c0d3
5	83cf130e-0e6f-4fa3-b8fa-7b54eaca5e17-00143d3b	UHMW, White	INT_OFFICE_2	6d817188-6587-49b7-af76-7dd65728c0d3
6	83cf130e-0e6f-4fa3-b8fa-7b54eaca5e17-00143d3a	UHMW, White	INT_OFFICE_2	6d817188-6587-49b7-af76-7dd65728c0d3
6	83cf130e-0e6f-4fa3-b8fa-7b54eaca5e17-00143d3a	UHMW, White	INT_OFFICE_2	6d817188-6587-49b7-af76-7dd65728c0d3
7	83cf130e-0e6f-4fa3-b8fa-7b54eaca5e17-00143d3b	UHMW, White	INT_OFFICE_2	6d817188-6587-49b7-af76-7dd65728c0d3
7	83cf130e-0e6f-4fa3-b8fa-7b54eaca5e17-00143d3b	UHMW, White	INT_OFFICE_2	6d817188-6587-49b7-af76-7dd65728c0d3
8	83cf130e-0e6f-4fa3-b8fa-7b54eaca5e17-00143d3b	UHMW, White	INT_OFFICE_2	6d817188-6587-49b7-af76-7dd65728c0d3
8	83cf130e-0e6f-4fa3-b8fa-7b54eaca5e17-00143d3b	UHMW, White	INT_OFFICE_2	6d817188-6587-49b7-af76-7dd65728c0d3
9	83cf130e-0e6f-4fa3-b8fa-7b54eaca5e17-00143d37	UHMW, White	INT_OFFICE_2	6d817188-6587-49b7-af76-7dd65728c0d3
9	83cf130e-0e6f-4fa3-b8fa-7b54eaca5e17-00143d37	UHMW, White	INT_OFFICE_2	6d817188-6587-49b7-af76-7dd65728c0d3

8278 Duplicate Objects found in 14 Different Models

Export

4.6.0.1 EXPORT DUPLICATE OBJECTS

You can export and view the data in an Excel file. Click the **Export** icon at the bottom right to start the export.

NOTE The default export file type is .csv.

The exported duplicate objects file can be imported to the archive library and attached to issues. You can then export them to a BCF export for the engineering team to review.

LESSON 4 REVIEW

1. _____ are created to detect clashes.
 - a. Styles
 - b. Tags
 - c. Coordination Rules
 - d. None of the above

2. Coordination rules can only be run individually.
 - a. True
 - b. False

3. _____ define the parameters around objects for clash detection.
 - a. Clearance settings
 - b. Coordination issues
 - c. Coordination rules
 - d. None of the above

LESSON 4 SUMMARY

As a result of this lesson, you can:

- Create and manage a coordination rule
- Create and manage coordination rule groups
- Define clearance settings

CHAPTER 5 – COORDINATION - ISSUE MANAGER

5.1 ISSUE MANAGER OVERVIEW

Issue Manager lets you turn geometric clash issues, model review, and site-walk findings into issues. Issues can be grouped and then assigned and tracked all the way to completion.

The Issue Manager contains 3 tabs:

- **Issues** – View the list of issues grouped in folders.
- **Details** - Lets you add additional information such as status, assignee, set location pins, resolution information, add additional views, attachments, and markups.
- **Summary** - Shows all clashes associated with the issue.

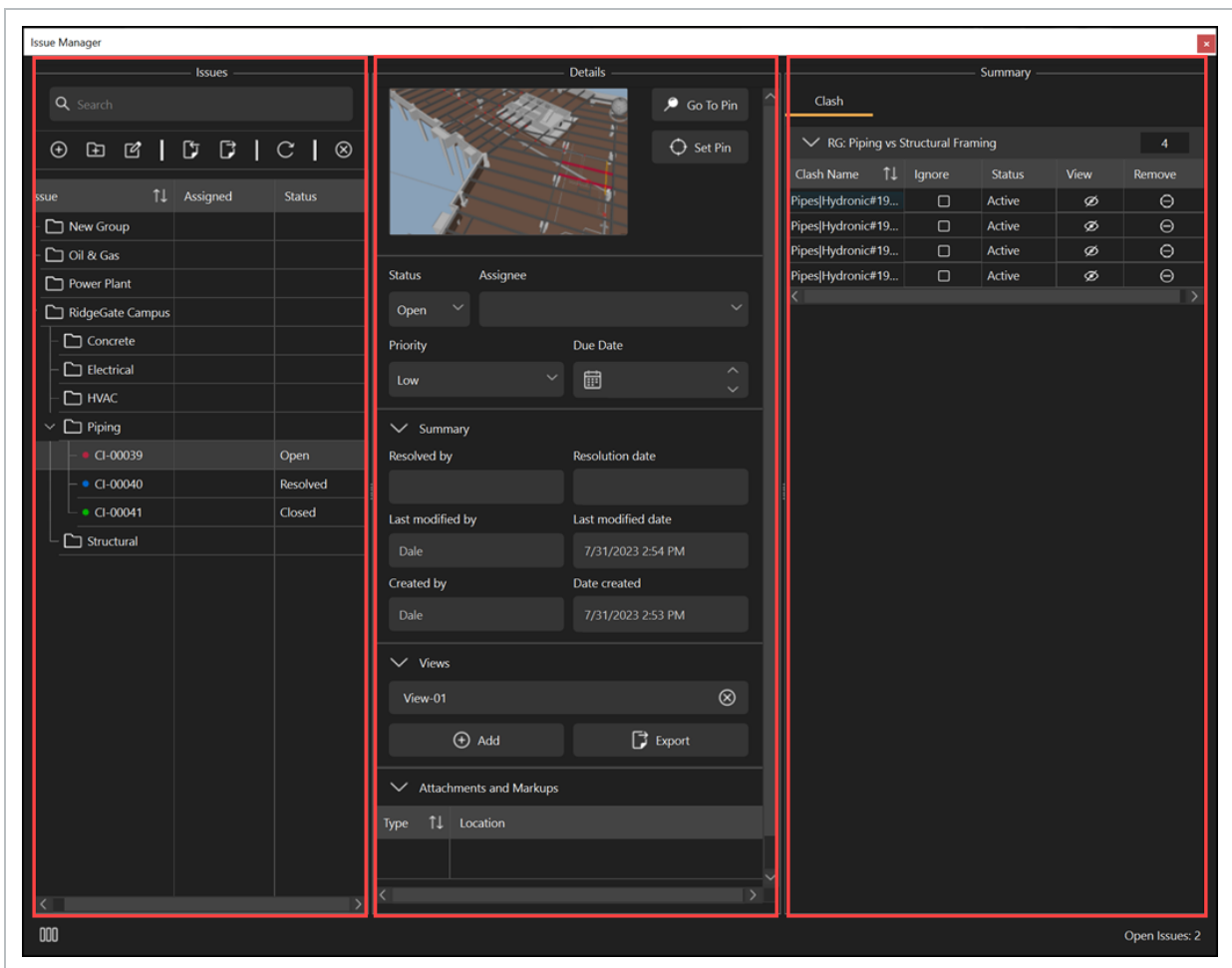

To view all tabs side-by-side, click the **Expand** icon at the bottom left of the panel.

5.2 CREATE AND MANAGE COORDINATION ISSUES

Coordination issues are groupings of geometric clashes, viewpoints, documents, and markups that can be assigned to a user or a user group. You can create coordination issues without a geometric clash. All issues created can be exported.

5.2.1 CONSIDERATIONS

When creating and managing issues, one best practice is to have the Clash Manager's Results panel and Issue Manager panel open side-by-side. After you run a clash rule or rule group, your focus will be on their results in the Clash Manager's Results tab and the Issue Manager.

5.2.2 STEPS

To open the Clash or Issue Manager, go to Logic > **Clash Manager** or **Issue Manager**.

ADD FOLDERS AND SUB-FOLDERS TO ORGANIZE ISSUES

1. In Issue Manager, to add a new folder, click the **Add folder** icon, and then name the folder.
2. To add sub-folders, select a folder, and then click **Add folder** icon.

CREATE A NON-GEOMETRIC CLASH ISSUE

1. Select a folder, and then click the **Add issue** icon. A new issue is created, and the Details panel opens to fill in the issue details.

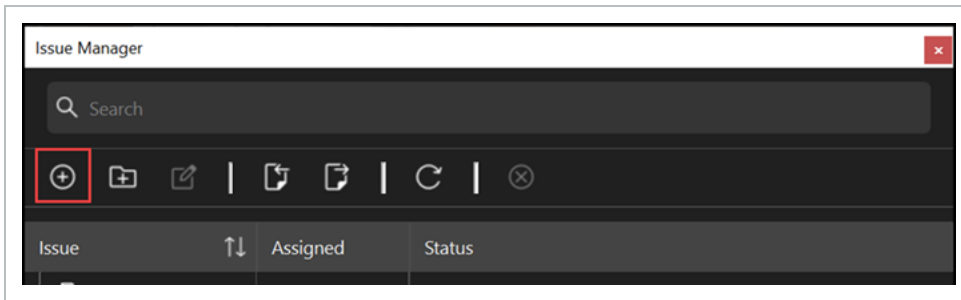

CREATE A COORDINATION ISSUE FROM CLASH RESULTS

1. Open the Clash Manager and the Issue Manager's panels side-by-side.
2. In Clash Manager, run a rule or rule group.
3. In Issue Manger, select or create a folder to push the clash results into.

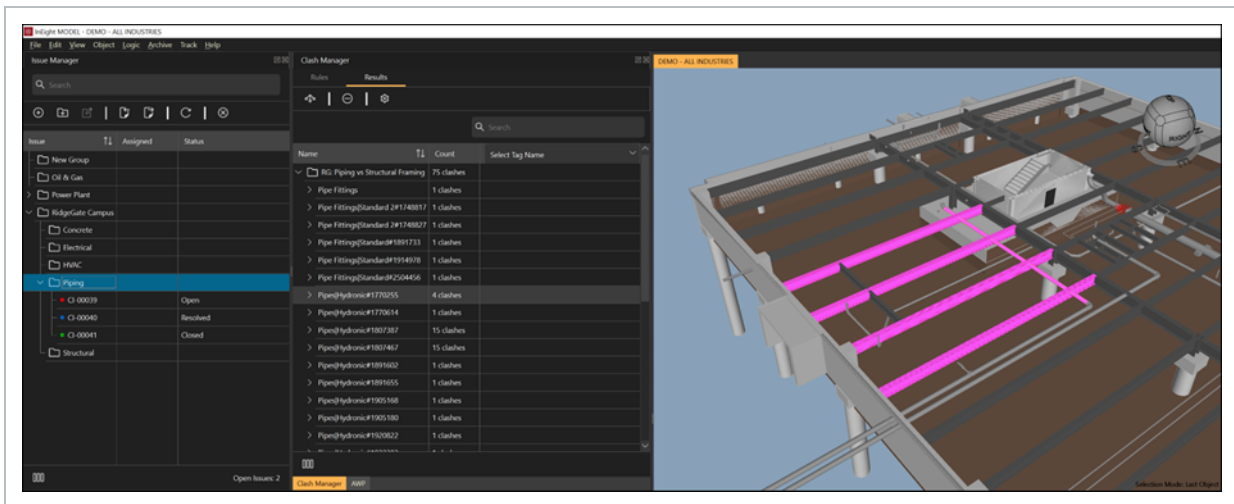

4. Select a clash result, and then in the viewer, zoom into the result.
5. Right-click the clash result, and then select **New Issue from selected result** or **Add selected results to current Issue**. The Details tab shows.

In the Details tab you can view and manage thumbnails, clashes, status, summary, views, attachments, and markups. For more information about the Details panel, see Details panel overview.

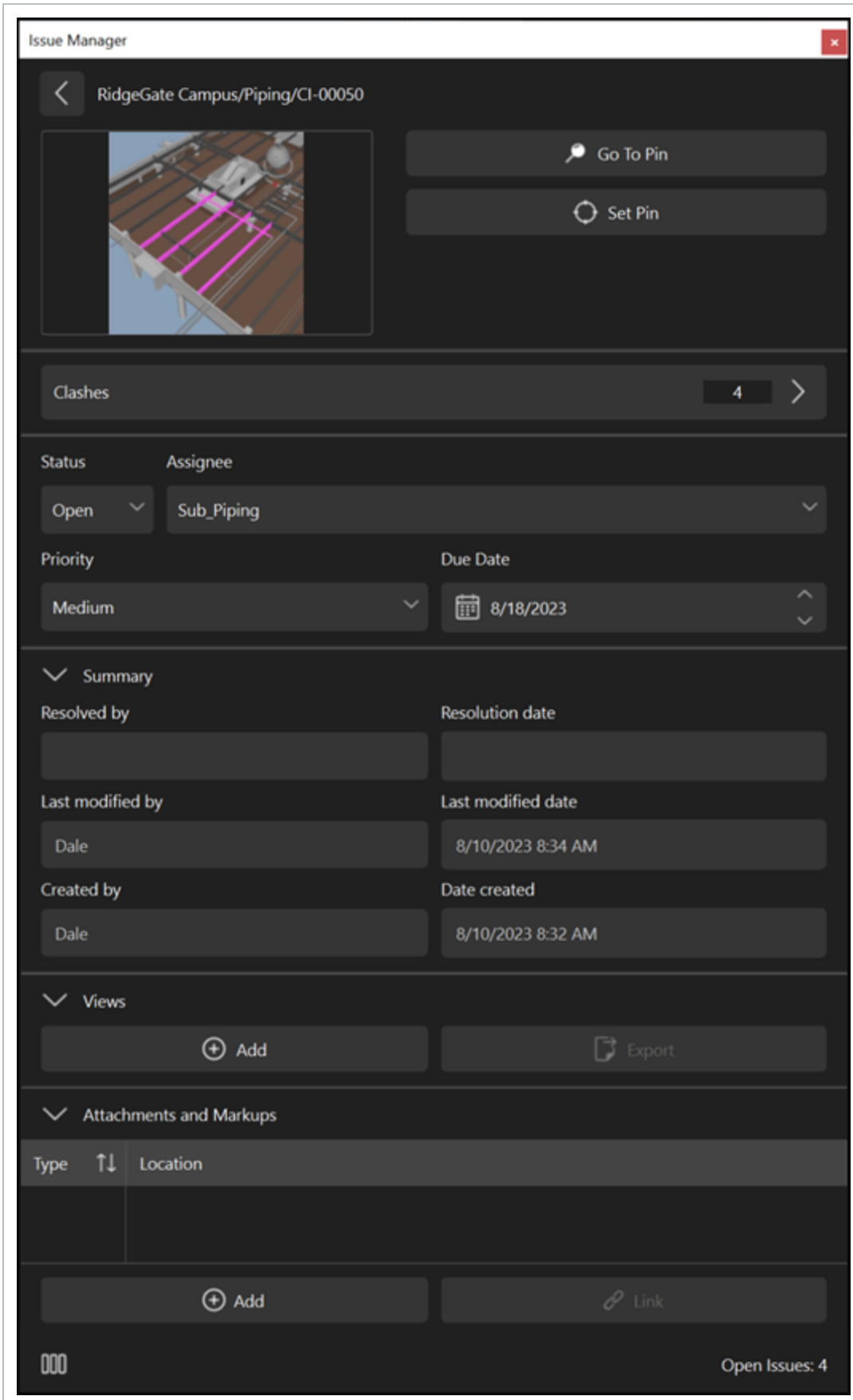

To view the all tabs side-by-side in Issue Manager, click the **Expand** icon at the bottom left.

NOTE

When you create an issue offline, the issue ID number shows as a GUID. An issue ID number is assigned the next time you are online.

ADD MARKUP

1. In the Details panel, under **Attachments and Markups**, click the **Add** button. A New Markup tab opens in the viewer window.

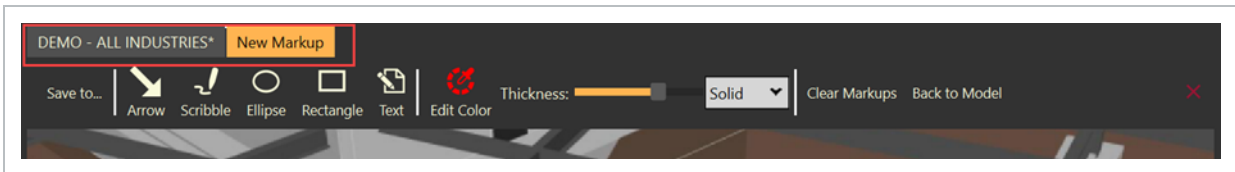

2. Markup the view using the markup tools.

NOTE

You can edit the size of the text by highlighting the text and then using the **Thickness** bar.

3. To save the markup, click **Save to...**, and then you can select **Issue...** or **File...**. When saving to Issue, it saves the markup to the issue. When saving to File, it saves the markup to a PDF file.

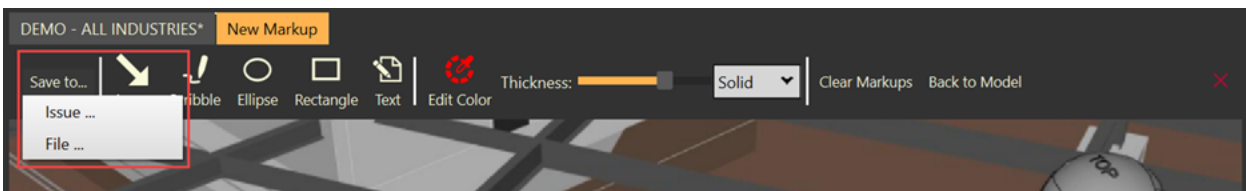

4. Click the **Back to Model** button to go back to the viewer.
5. To close the markup view, click the **Close** icon at the far right.

EDIT AN ISSUE

1. Select an issue, and then click the **Edit issue** icon. The issue opens in the Details panel.

You can view and edit thumbnails, pins, clashes, status, assignee, priority, due date, summary, views, attachments, and markups.

2. Select **Clashes** to view all clashes in the issue. You can edit active clashes and change to **Ignore** or **Resolved**. When all the clashes are set to Ignored or Resolved, the issue status automatically shows as Resolved.

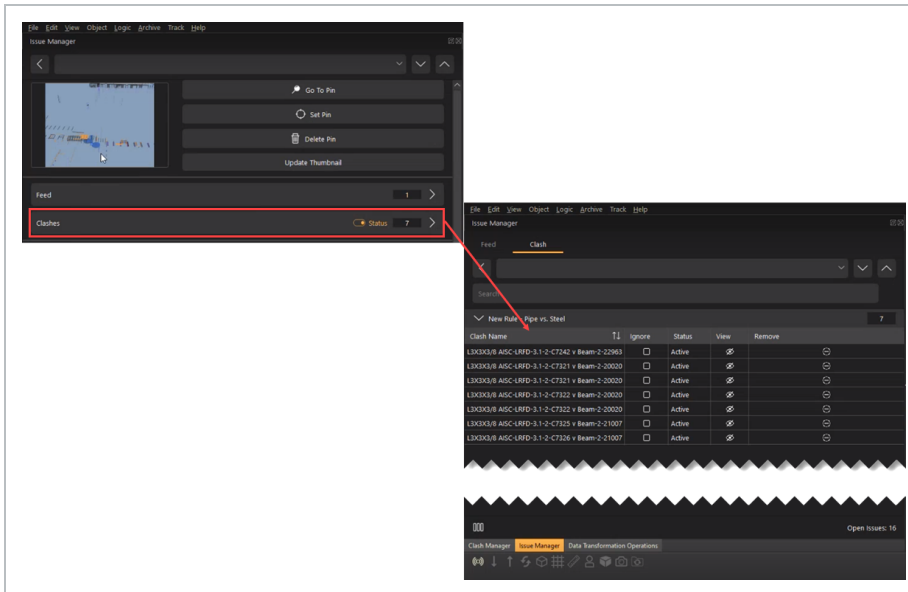
**NOTE**

When an issue is in Resolved status, the coordinator responsible should visually inspect the issue to ensure it has been resolved in a satisfactory manner. The coordinator can then change the issue status to **Closed**.

The status for a clash or clashes is automatically set to invalid when one or both intersecting objects are deleted in the design application, the model is published to InEight Model, and the **Update Issue** function is executed.

An invalid status indicates that InEight Model can no longer detect the clash since it cannot detect the source object or objects. Invalid clashes are treated as resolved.

IMPORT ISSUES

1. In the Issues panel, select the **Import** icon.
2. Select your BCF file, and then select **Open**. Your files are imported to an **Imported Issues** folder.

EXPORT ISSUES

1. In the Issues panel, select one or more issues or select a group folder that contains issues.
2. Click the **Export** icon, and then select **BCF 2.1** or **BCF 3.0**.
3. You can then name and save the file. The file is saved in a *.bcfzip* file format which can be opened in other applications as shown in the image below:

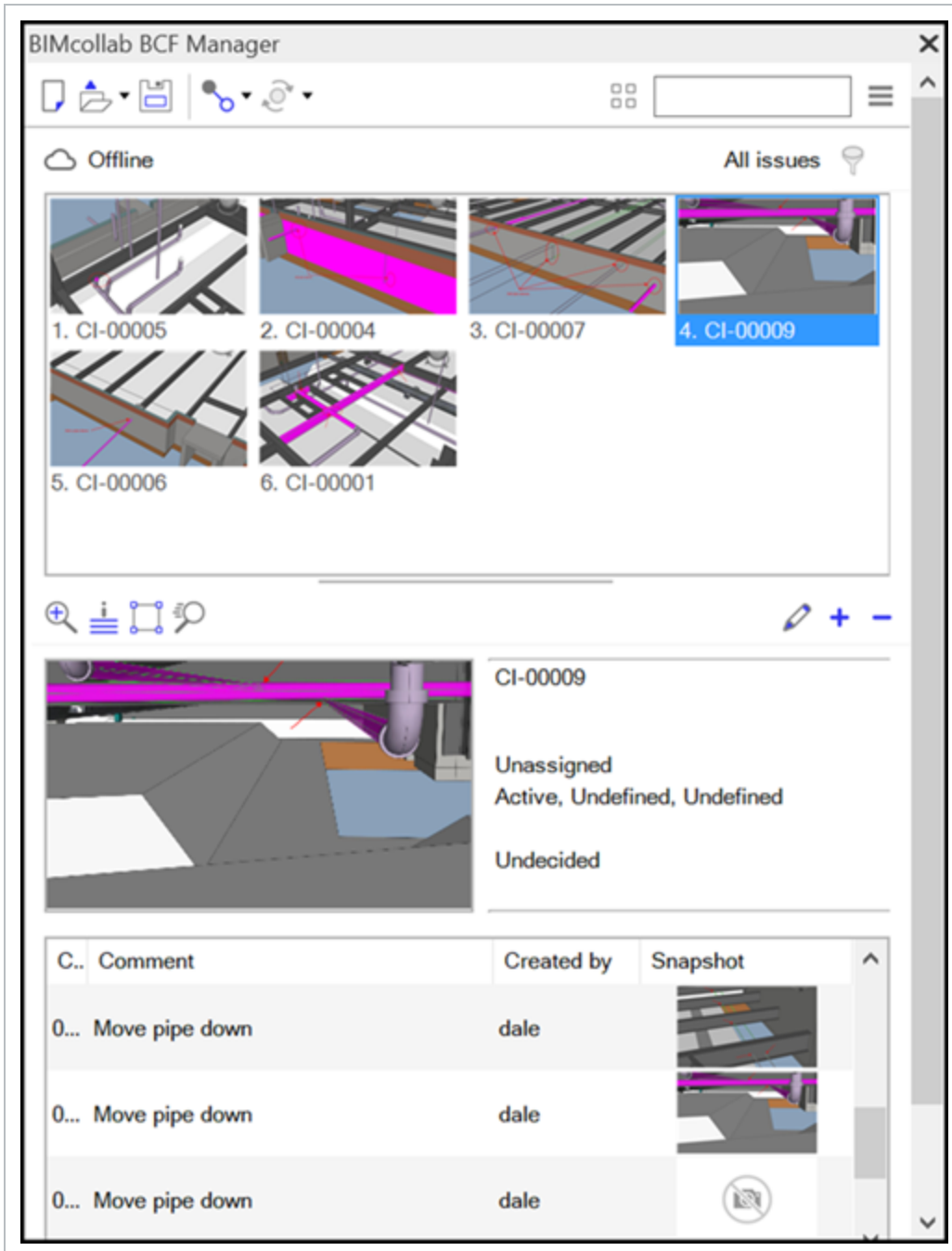

UPDATE ISSUES

1. Publish a new model revision.
2. Click the **Update Issues** icon.

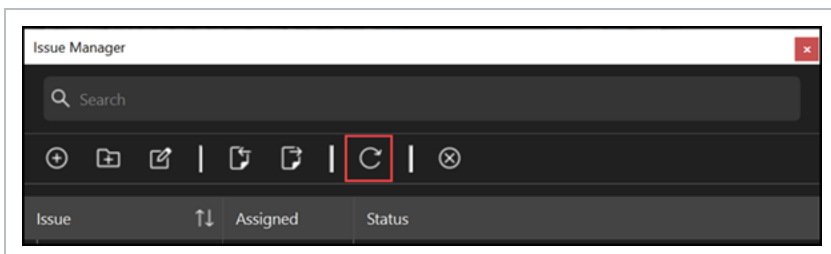

The resolved clashes automatically change the clashes in the issues to a Resolved status. If all clashes are resolved, the status for the Issue also shows as Resolved.

DELETE A COORDINATION ISSUE

1. Select a coordination issue, and then click the **Delete** icon.

5.3 COORDINATION ISSUE REPORTING

Coordination Issue Reporting can be achieved by accessing Issues through the Excel plugin.

ACCESS ISSUES VIA EXCEL PLUGIN FOR REPORTING

1. In Excel, select **InEight** in the menu ribbon.
2. Click the **Login** icon to log into your project. The Login to InEight dialog box opens.

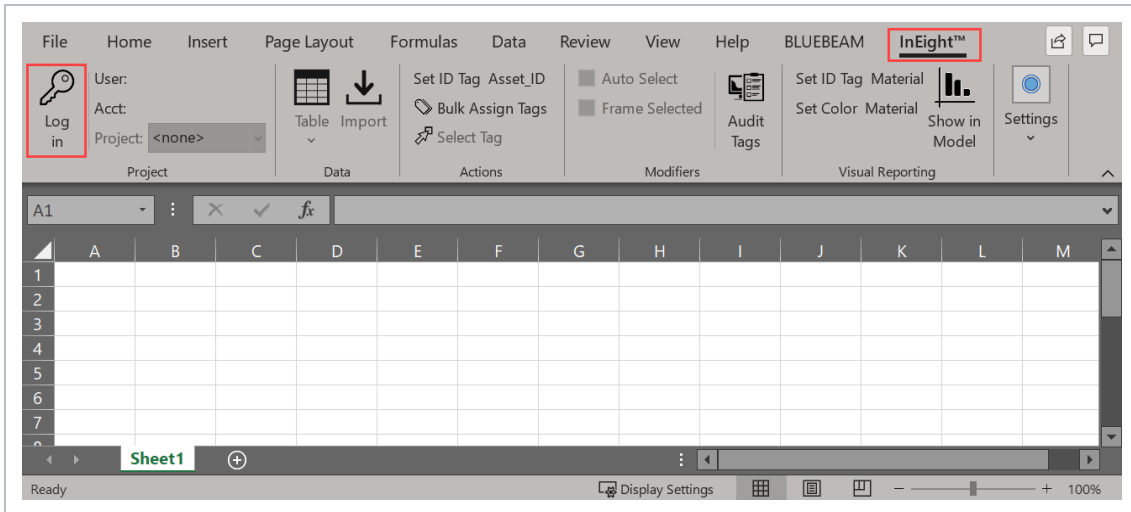

3. Enter your **password**.

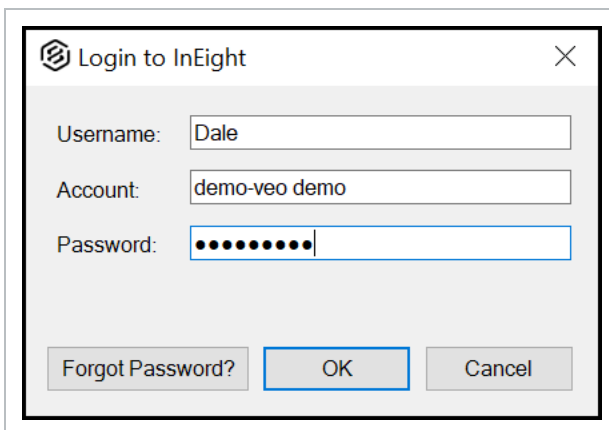

- The Select Project dialog box opens.

4. Select your project, then click **OK**.

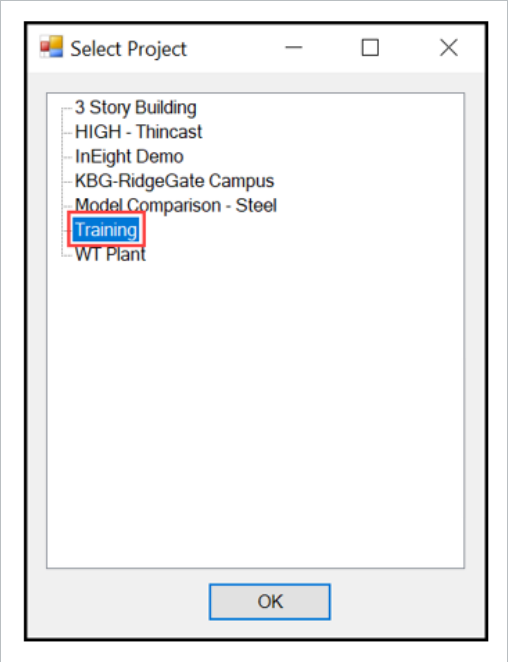

- User, Acct, and Project are shown.

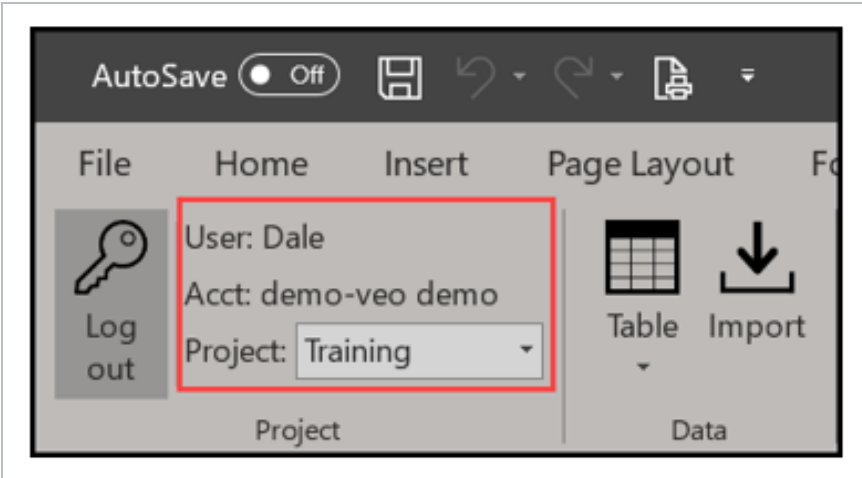

5. Select the **Table** icon.

6. Hover over Tracked Issues > Tracked Issue, and then click **Query All**.

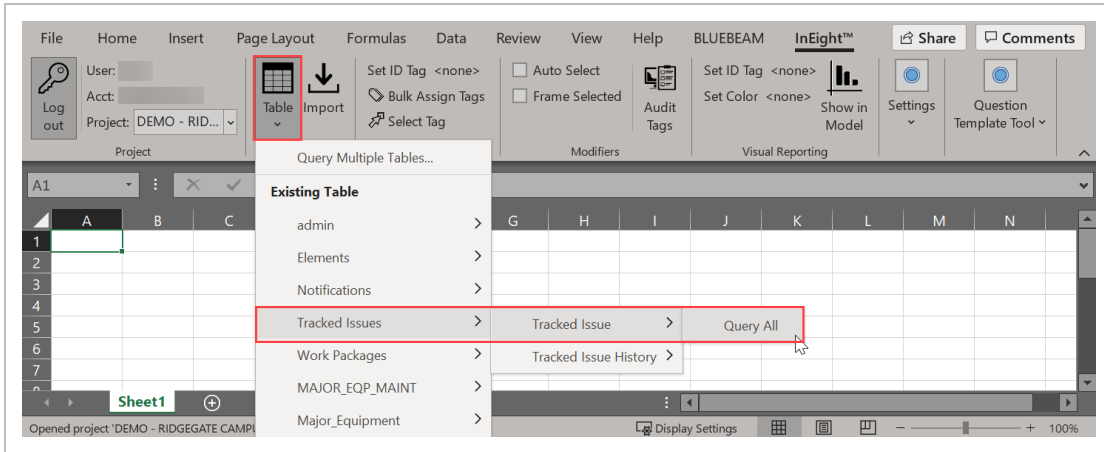

NOTE All the Coordination issues are shown. This is a direct view into the database tables

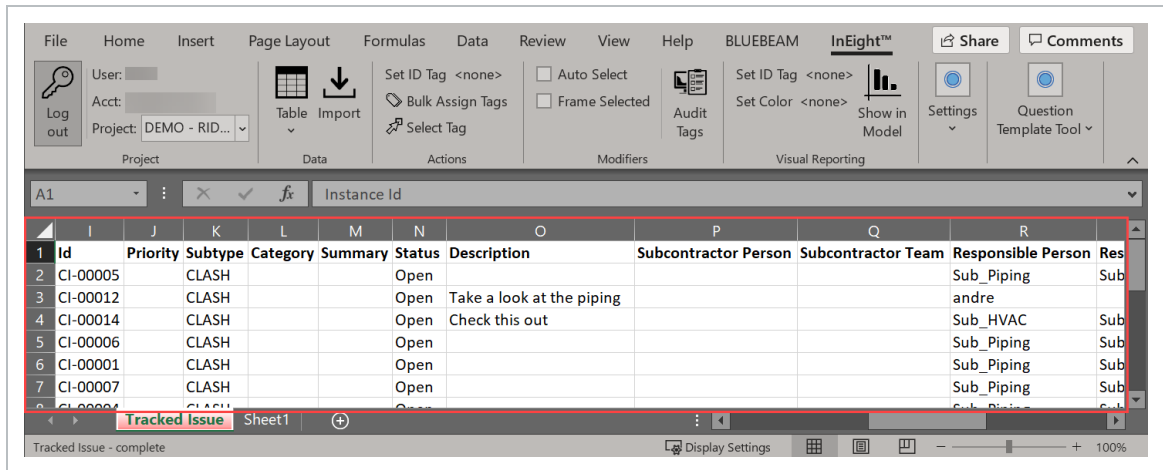

LESSON 5 REVIEW

1. Coordination issues are created from _____ .
 - a. Model streams
 - b. Tags
 - c. Master presets
 - d. Clashes

2. Issue statuses always start as _____ .
 - a. In progress
 - b. Open
 - c. Closed
 - d. Flagged

3. After resolving a coordination issue, the reviewer should physically review the site to ensure the issue (and any potential related issues) is resolved.
 - a. True
 - b. False

LESSON 5 SUMMARY

As a result of this lesson, you can:

- Create clash results
- Create and manage coordination issues
- Find nearby clashes and add clashes to an existing issue
- Create and manage coordination results

CHAPTER 5 – DOCUMENT ISSUE INTEGRATION

5.1 Document issue integration	415
--------------------------------------	-----

5.1 DOCUMENT ISSUE INTEGRATION

You can link Model issues with InEight Document forms. Linking issues with Document lets you have a single repository for issues, reducing the manual process and providing scalability.

Issues created in Model can be linked to a Document form by selecting the **Add** or **Link** buttons in the Documents section of the issue.

NOTE To link an issue, it must first be created and saved.

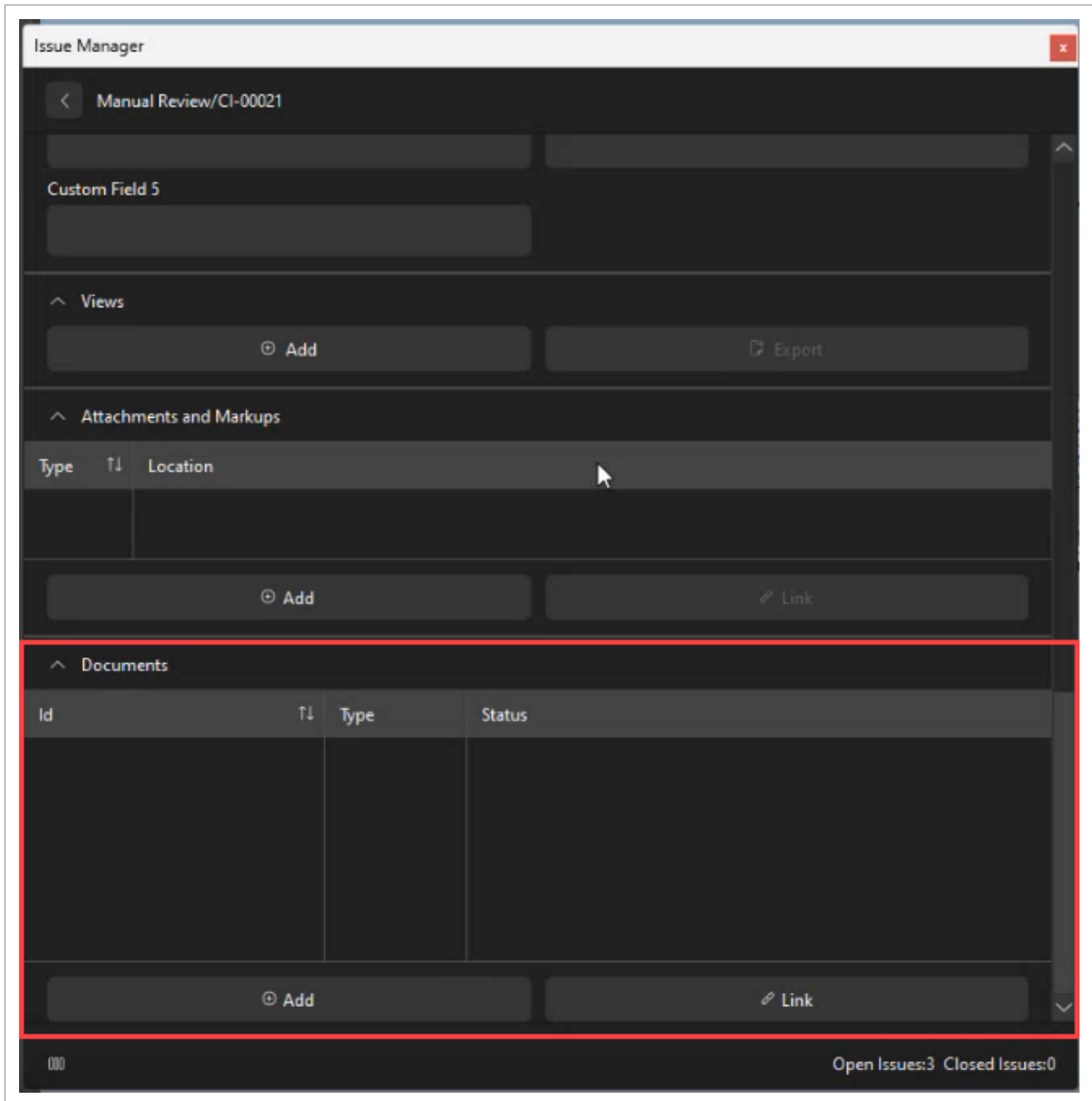

- **Add**

The Add button gives you the option to link an issue to a new form type in Document. [Read more](#)
Click **Add**, and then click the **Select Form Type to create** drop-down list to select from the form types available for the job.

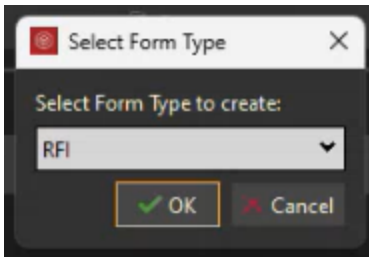

Document opens with the newly created form type for you to fill out and save.

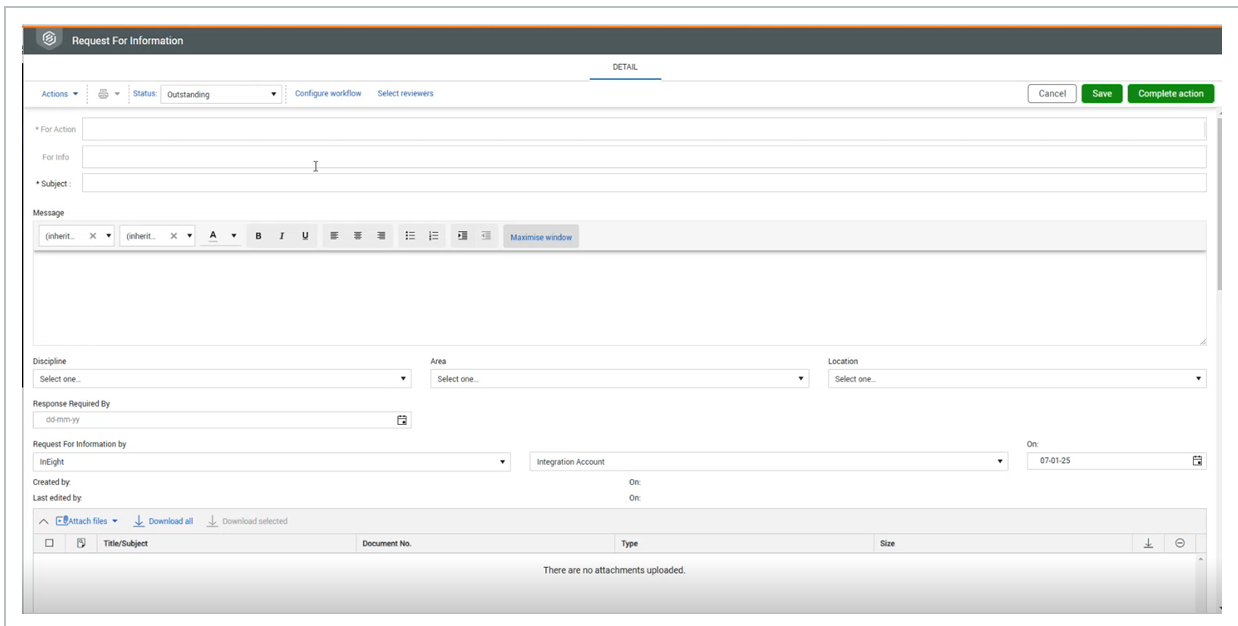

- **Link**

The Link button gives you the option to link an issue to an existing form in Document. [Read more](#)

When you click **Link**, Document opens the search page. You can click the **Search criteria for** drop-down list and optionally set filters to search for the applicable form, and then select from the work items in the **Selected work items to link** window.

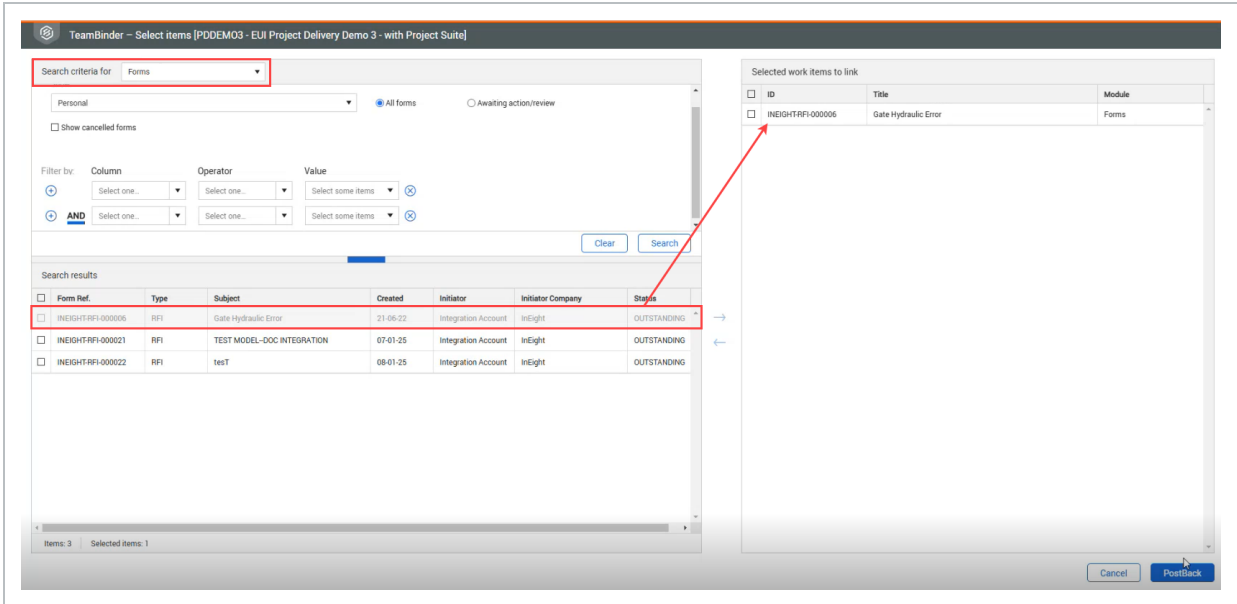

NOTE You must update your Model project for the Document links to show.

After you add or link an issue, a message shows at the top of the issue stating that the issue is being managed by Document. The link to the document shows in the Documents section of the issue.

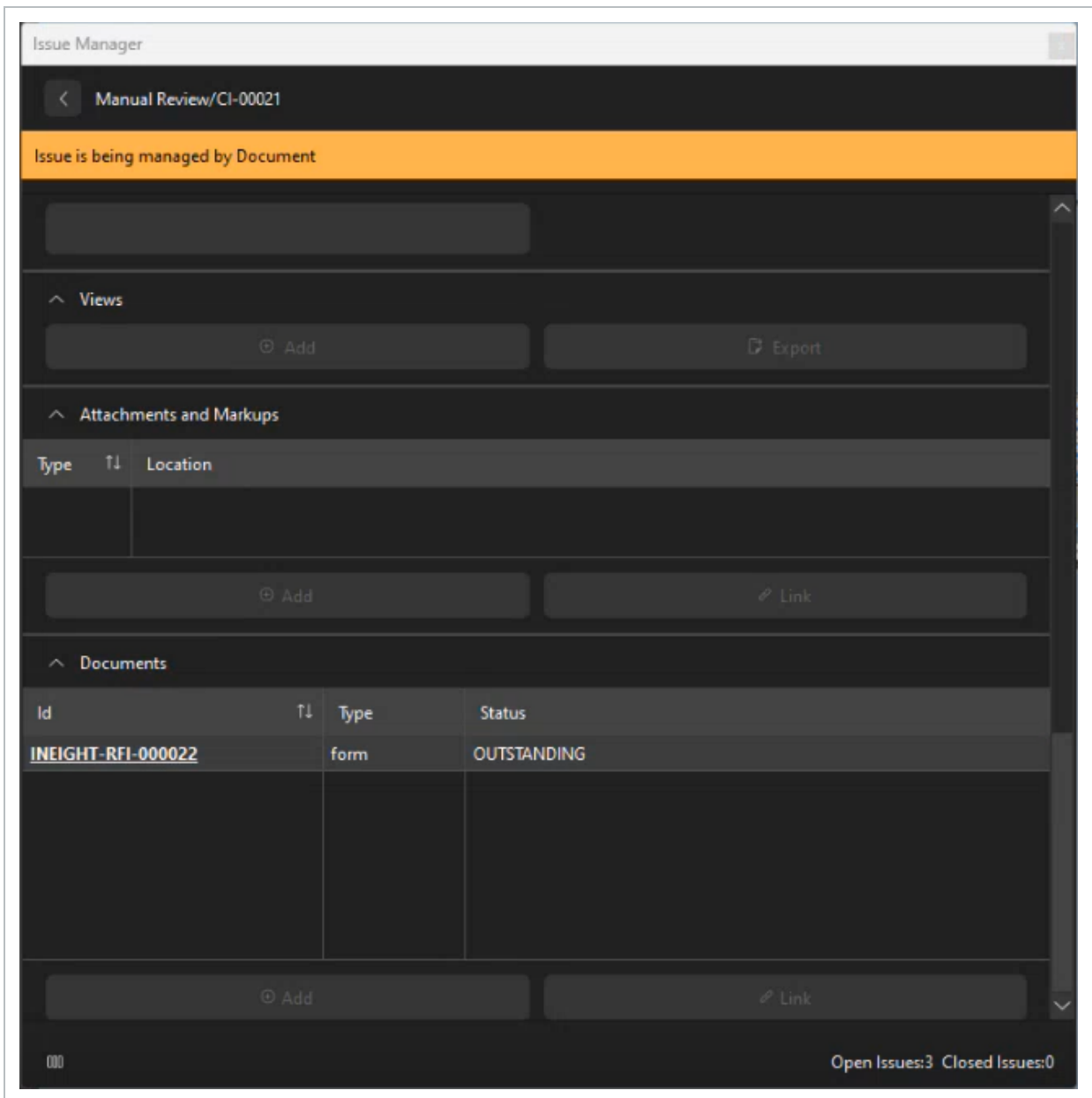

To open the issue in Document, click the **ID** link.

NOTE

Model issues linked to Document cannot be modified. When the issue form is closed in Document, you can then take action on the issue in Model.

For more information about Document forms, see [Forms](#).

This page intentionally left blank.

CHAPTER 6 – ARCHIVE

6.1 ARCHIVE OVERVIEW

The **Archive** is a repository for documents. Archive supports files of any size and type, provides fine-grained permission controls, and retains a complete revision history. The Archive is accessible within InEight Model, Mobile and Web applications.

Archive includes **Archive Library** for storing and managing files, and the **Archive Viewer** for viewing supported files types.

Archive Library

Library Selection Filter Search

File Name	Labels	Type	Last Modified
Issue_Attachments			
Duct Insulation.docx		DOC	Wed Mar 25 10:32:59 2020
What is InEight Model.pdf		PDF	Mon Apr 6 10:22:33 2020

Import Folder Assign Label Download Delete

Archive Library Selection Information

Archive Viewer

Selection What is InEight Model.pdf

52 % 1

What is InEight Model

Common Data Environment

- Models
- Integrations
- Quality
- Maintenance
- Project Analytics
- Project Status and Health
- Field Execution
- Estimate
- Schedule
- Documents
- Planning and Execution
- Quantity and Cost Tracking
- Receiving Material
- Commissioning and Turnover

6.1.1 ARCHIVE LIBRARY

View, manage, and organize all project documents within the Archive Library. Create labels and link documents to model object tags for enhanced usability.

To launch the Archive Library panel, select **Archive > Library**.

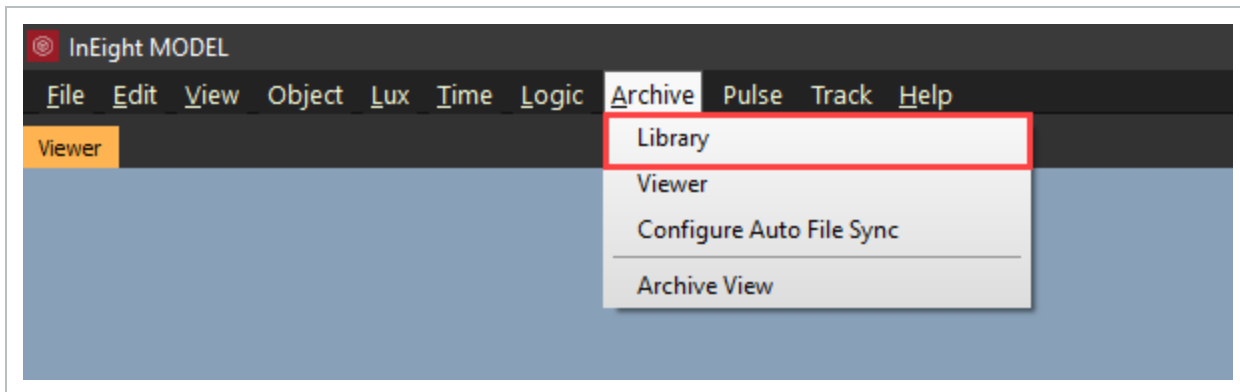

The **Archive Library panel** has two tabs: the Library tab and the Selection tab.

6.1.1.1 LIBRARY TAB

The **Library Tab** contains all the documents imported into the project. It provides the means to organize documents within a folder structure and to link documents to model object tags.

TIP

Documents associated to tags will maintain its association through model updates, assuming no manipulation to tags.

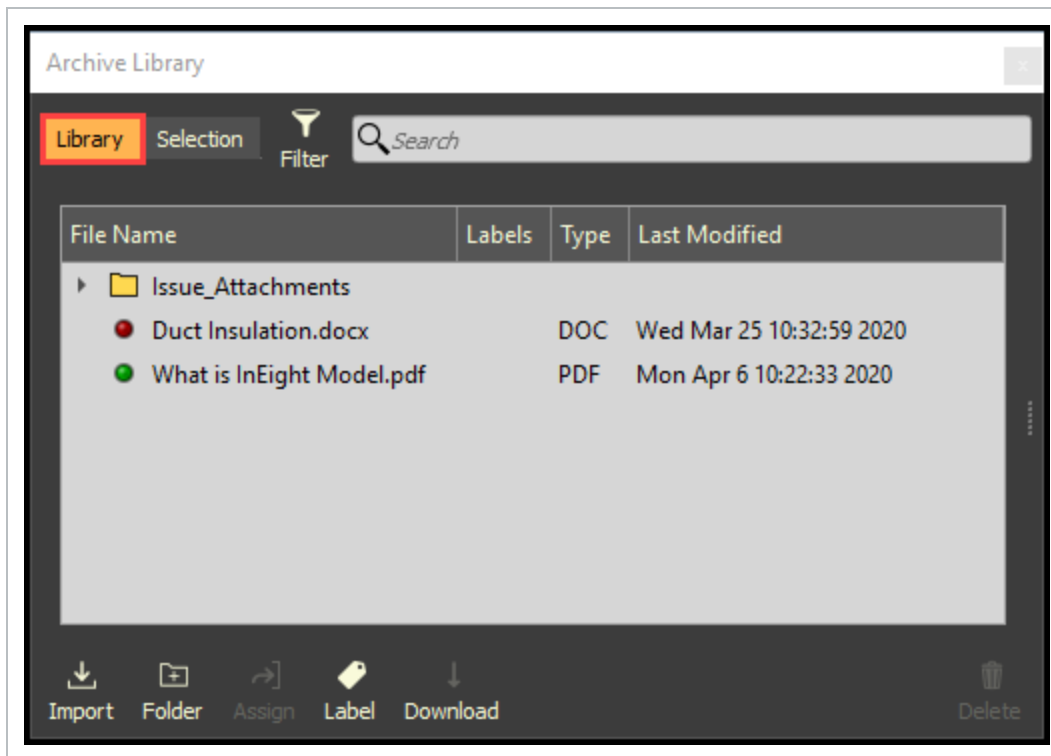

6.2 MANAGE DOCUMENTS

Documents can be grouped in a folder structure, have permissions set at the folder level, have labels assigned, and access document information.

6.2 STEP BY STEP 1 – IMPORT DOCUMENTS

Documents in the Archive Library are either cached locally or only indexed from the online database. Any document uploaded is automatically cached locally on the computer that uploaded it and is represented by a green dot.

1. Select the **Import** icon.
2. Then select either **File** or **Directory** from the drop-down menu.

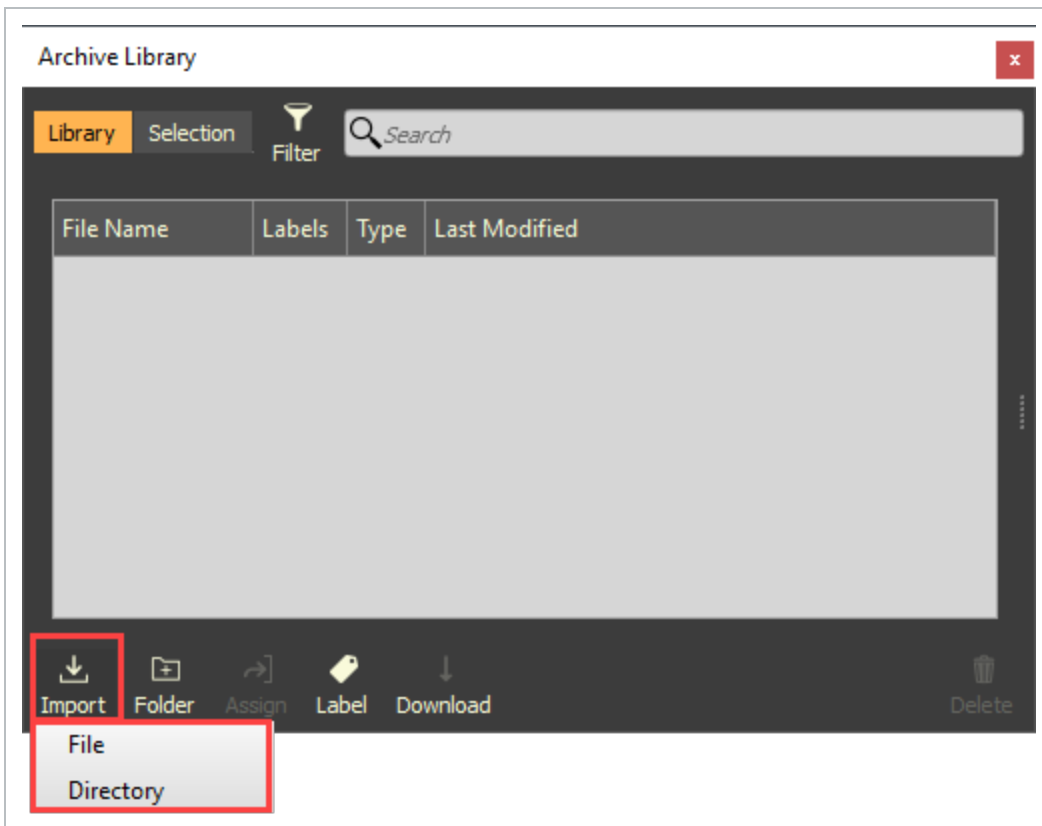

- Windows Explorer opens

TIP Drag and drop files and/or file folders into the Archive Library panel.

3. Browse to the File or Directory location.
4. If **File** was selected, select one or multiple documents to be imported, then click **Open**.
If **Directory** was selected, select on the directory folder to be imported, then click **Open**.

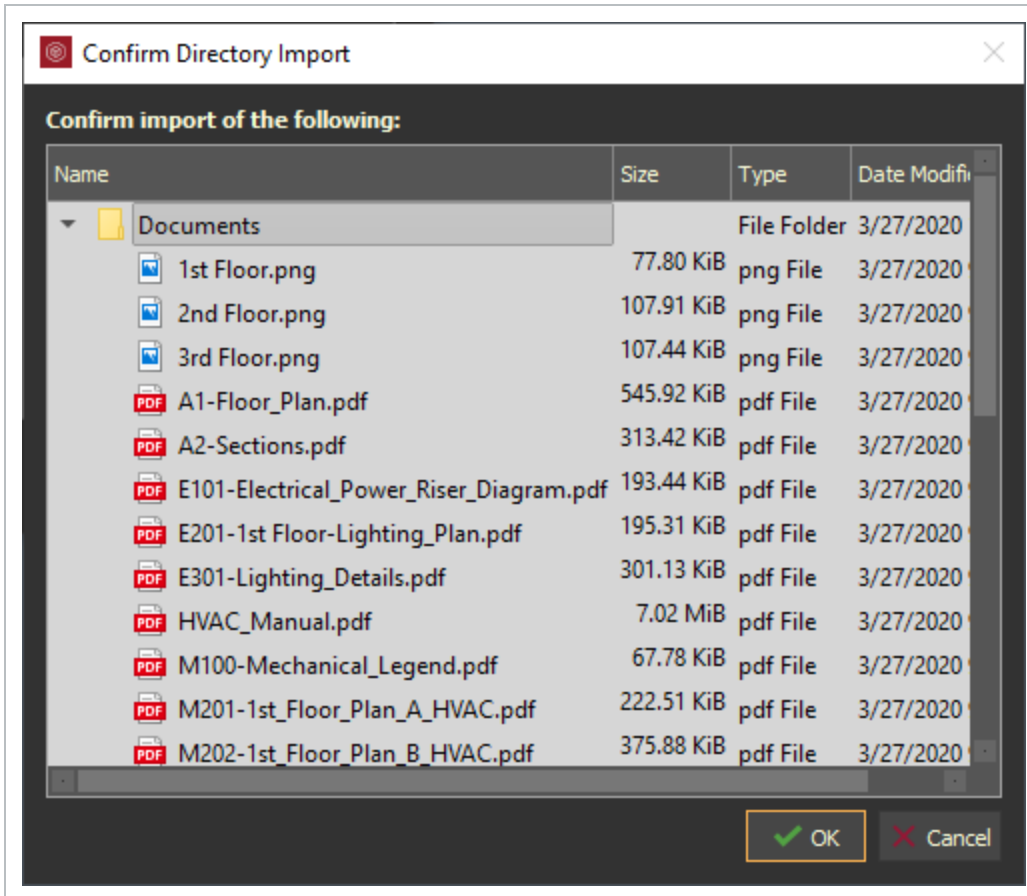

- The Confirm Directory Import dialog box opens

5. Click **OK**.

6.2 STEP BY STEP 2 – DOWNLOAD DOCUMENTS

Any document within the Library represented with a red dot is only indexed from the online database and needs to be downloaded to access it.

1. Within the Archive Library panel, select one or multiple documents.
2. Then select the **Download** icon.

- Or right click and select **Download Selected**

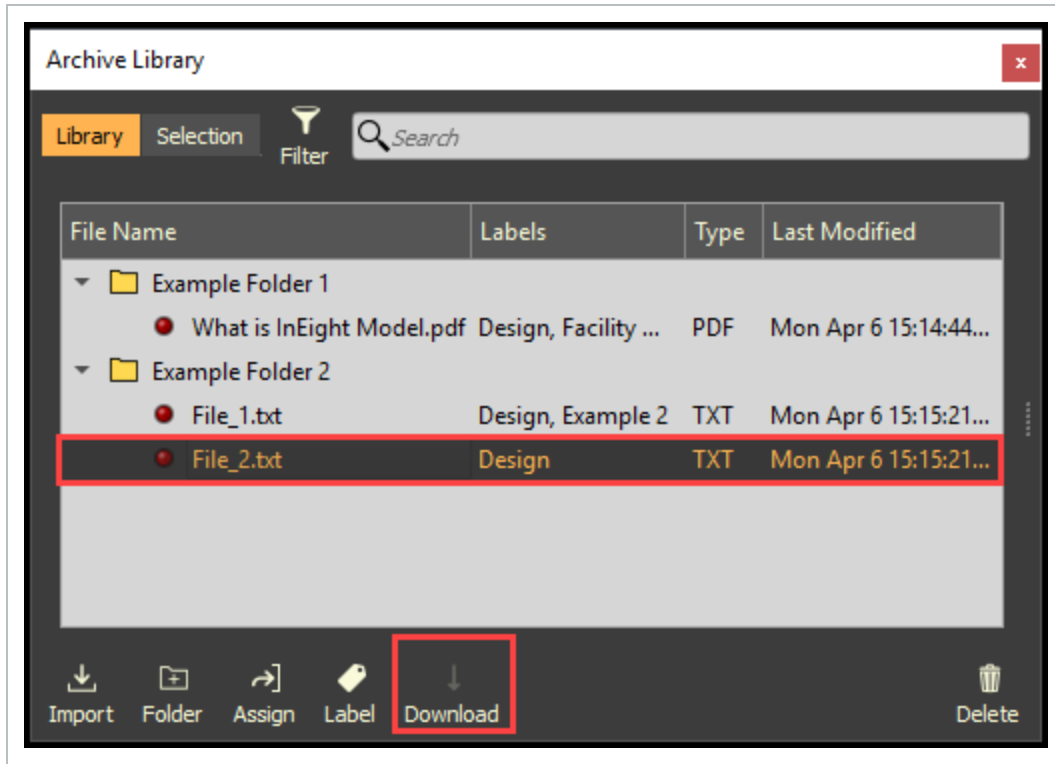

- The Download dialog box opens

3. Click **Download Selected**.

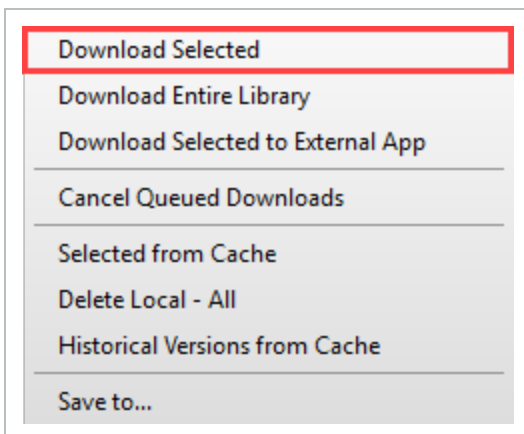

- **Download Entire Library:** downloads and caches the entire library. **Warning:** this can take a long time and use a lot of disk space with large libraries

- **Download Selected to External App:** downloads the file directory to the local computer without caching it locally to VEO_Cache
- **Save to...:** saves selected to a specific location

6.2 STEP BY STEP 3 – ORGANIZE DOCUMENTS

Organize and group documents by creating folders. Drag and drop folders and documents to rearrange them as desired. Right click on the document or folder to rename it.

1. Within the Archive Library panel, click the **Folder** icon.
2. Name the folder.

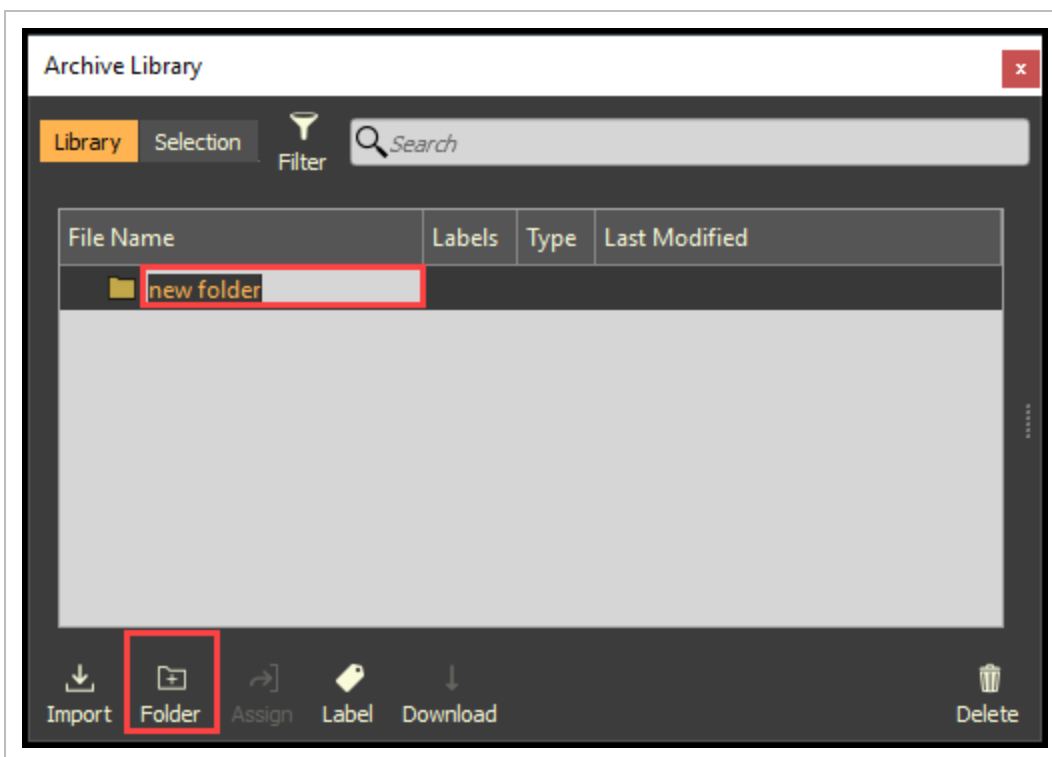

6.2 STEP BY STEP 4 – DELETE DOCUMENTS OR FOLDERS

1. Select one or multiple document(s) or folder(s), then click the **Delete** icon.
2. Answer the validation response(s).

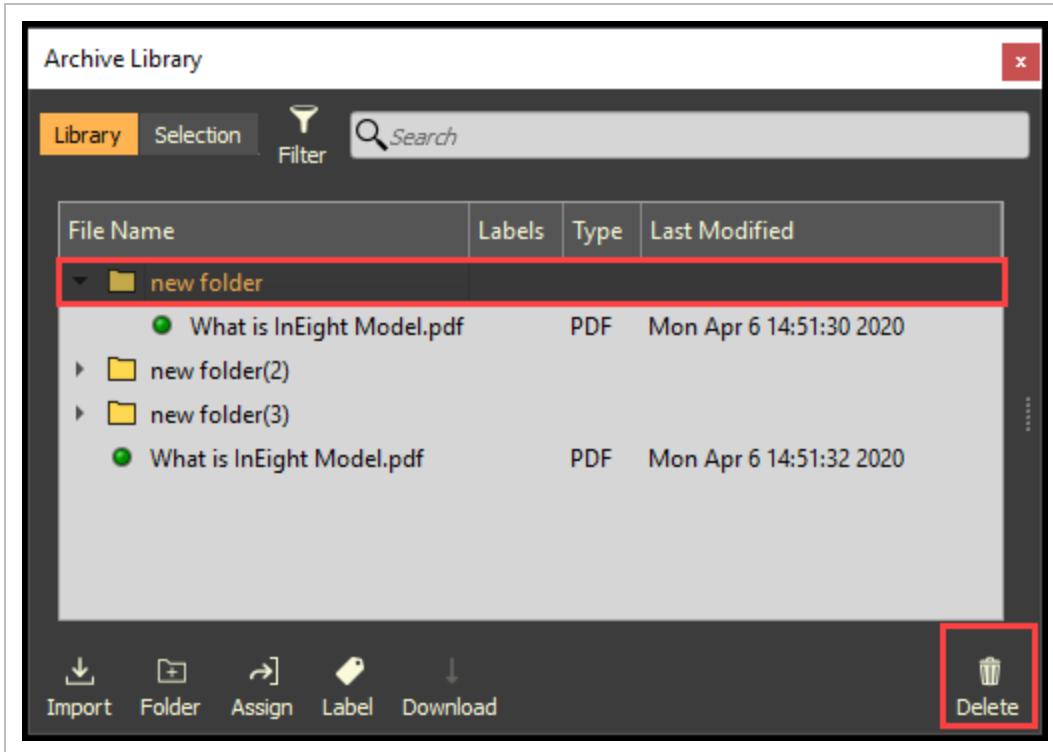

NOTE

Deleting a folder will delete all documents within the folder. The deleted document/folder is not deleted from the local cache.

There are additional options for removing documents/folders within the **Right Click menu** under **Delete**:

- Delete > **From Archive Library**: removes document/folder from library (same as Delete icon)
- Delete > **Selected from Cache**: removes only the local cache copy of a document
- Delete > **Historical Versions from Cache**: removes previous versions of document/folder from local cache

- **Delete > Upload Data from Cache:** removes all locally uploaded document/folders from local cache **Warning:** this can take a long time and InEight Model will be unresponsive while it is in progress

6.2 STEP BY STEP 5 – ACCESSING DOCUMENT INFORMATION

Additional document information is maintained within the document information window within the Archive Library panel.

1. Select a document.
2. With the mouse on top of the slider bar, click and slide open.
 - Or right click on a document and select **Show Document Information**

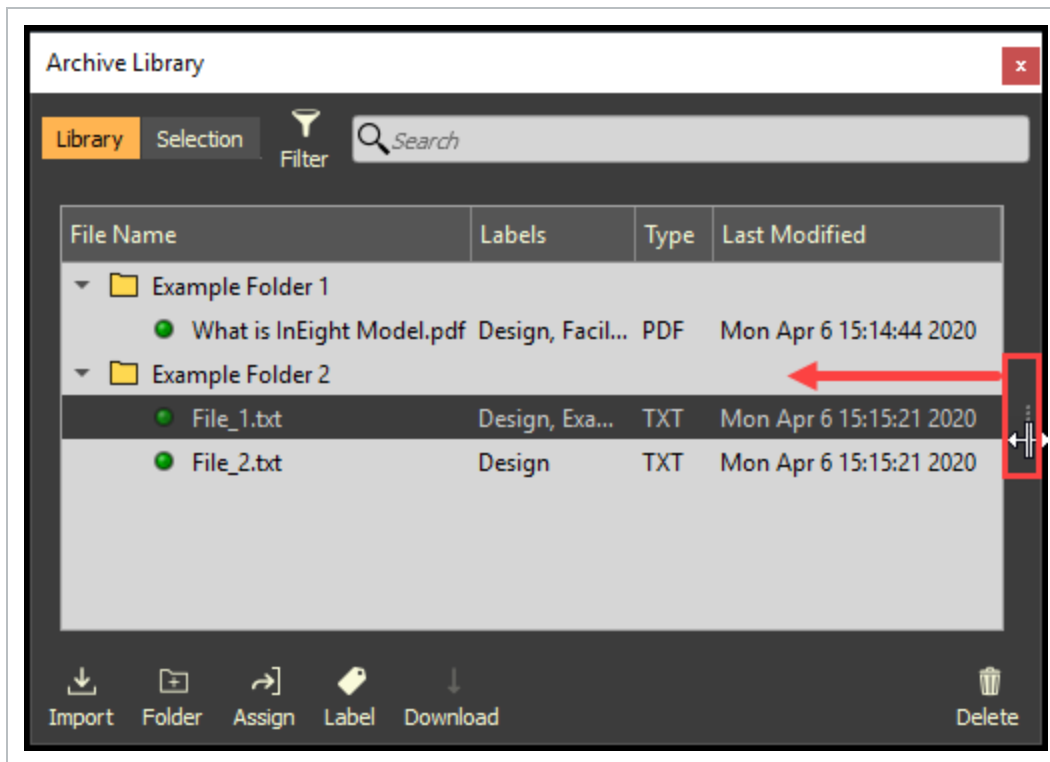

- The Document Information window opens

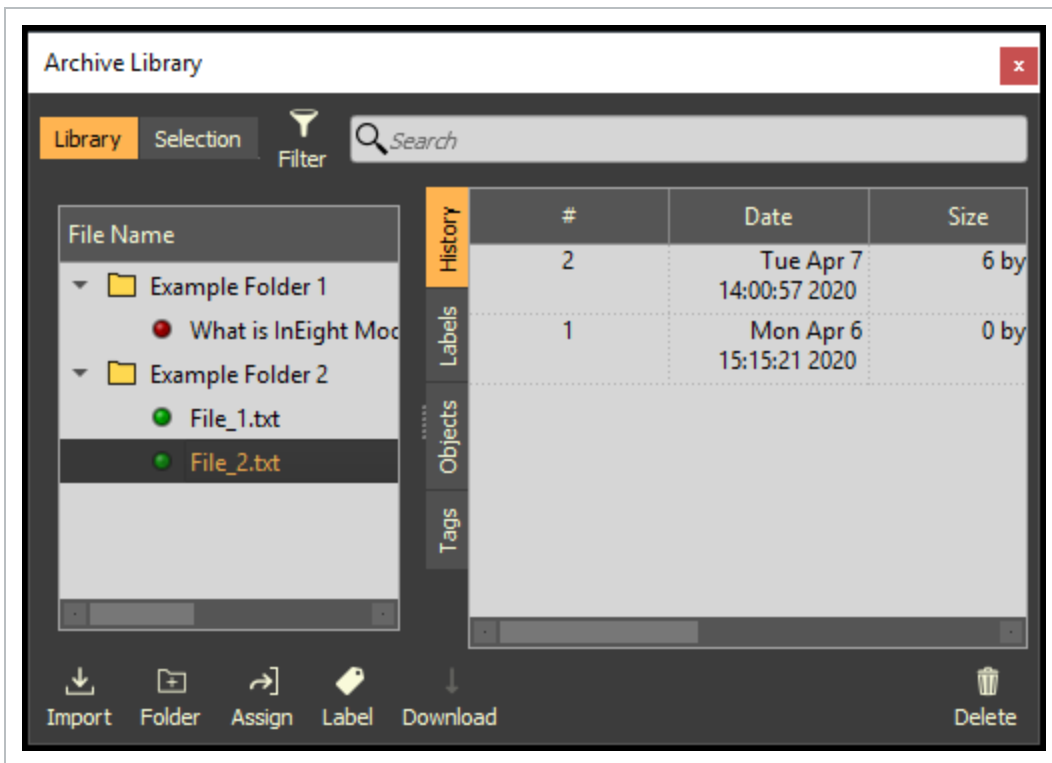

- **History:** displays the historical information of the document
- **Labels:** displays the list of available labels and which labels are associated to the document
- **Objects:** displays objects linked to the document
- **Tags:** display tags linked to the document

TIP

Right click on a document and select **Copy Selected File Information to Clipboard** to paste document information to an external application (i.e. MS Excel, Word, Email, etc.).

6.2 STEP BY STEP 6 – APPLY PERMISSIONS TO FOLDERS

NOTE

Only Admin users can apply specific folder permissions. By default, folder permissions are inherited by project level permissions.

Permissions can be set at the folder level. Nested folders inherit parent folder permissions. By default, folder permissions inherit project permission for users.

1. Select a folder, then right click and select **Edit Folder Permissions**.
 - The Set Archive permissions dialog box will open

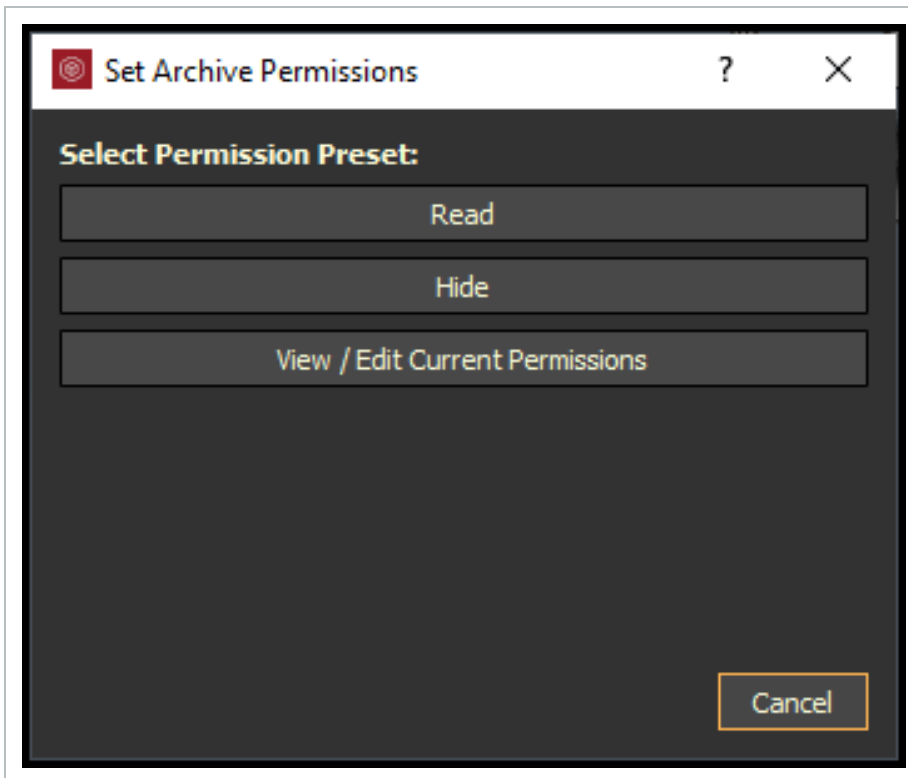

There are three permission levels:

- **None Granted:** folder is hidden
 - **Can Read:** read-only permissions
 - **Can Read and Write:** has read, write, and edit permissions
2. Select a Read permission.
 - Can Read permissions are auto assigned to all groups within the system and all users assigned to the project

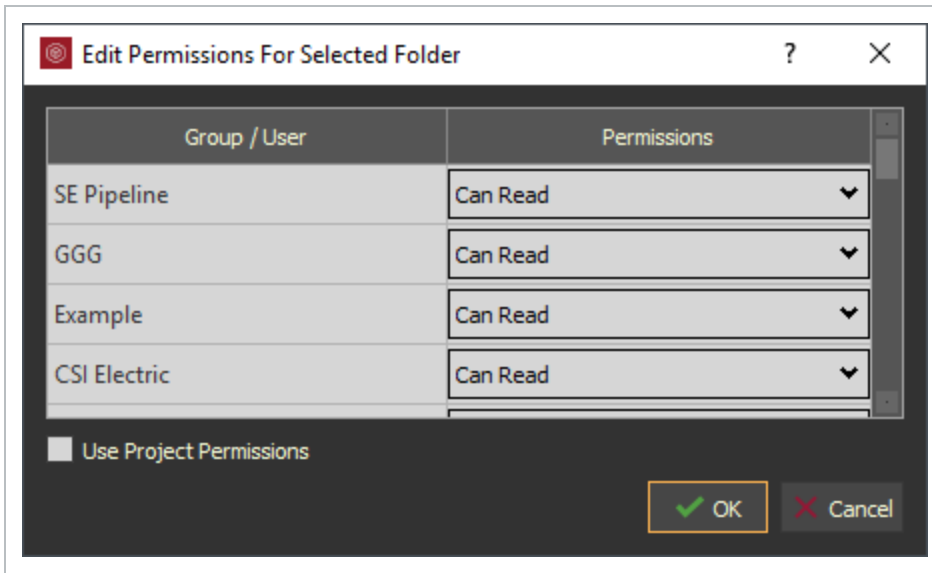

3. Make any changes as desired, then click **OK**.

4. Select a **Hide permission**.

- None Granted permissions are auto assigned to all groups within the system and all users assigned to the project

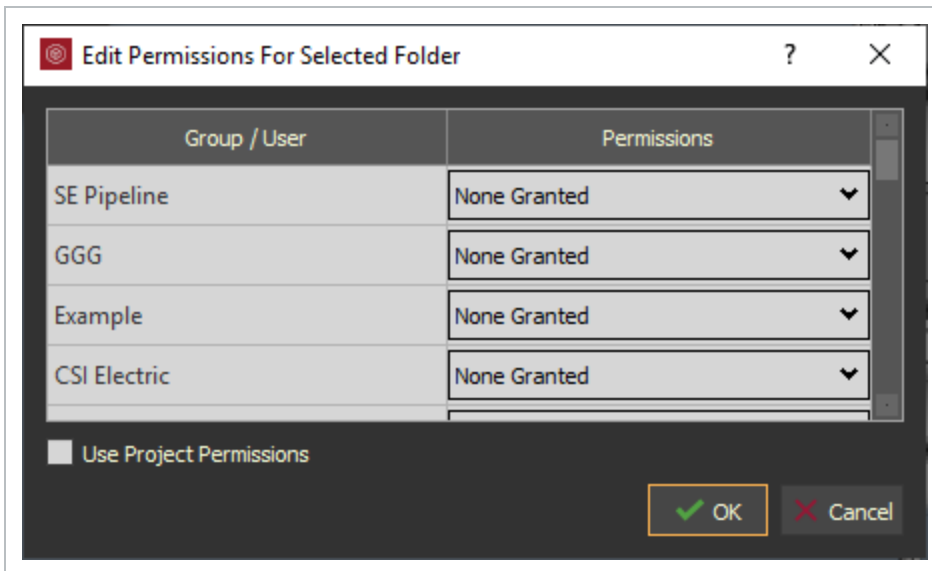

5. Make any changes as desired, then click **OK**.

6. Select **View / Edit Current Permissions**.

- Displays all Current Permissions for the folder with applying any changes as it opens

6.2 STEP BY STEP 7 – SEARCH DOCUMENTS

Search filters the library list to the criteria in the search bar and only searches on the File Name of the Document and/or Folder.

NOTE When using Filters in conjunction with Search, only visible content is searched.

1. Type in criteria within the Search bar.

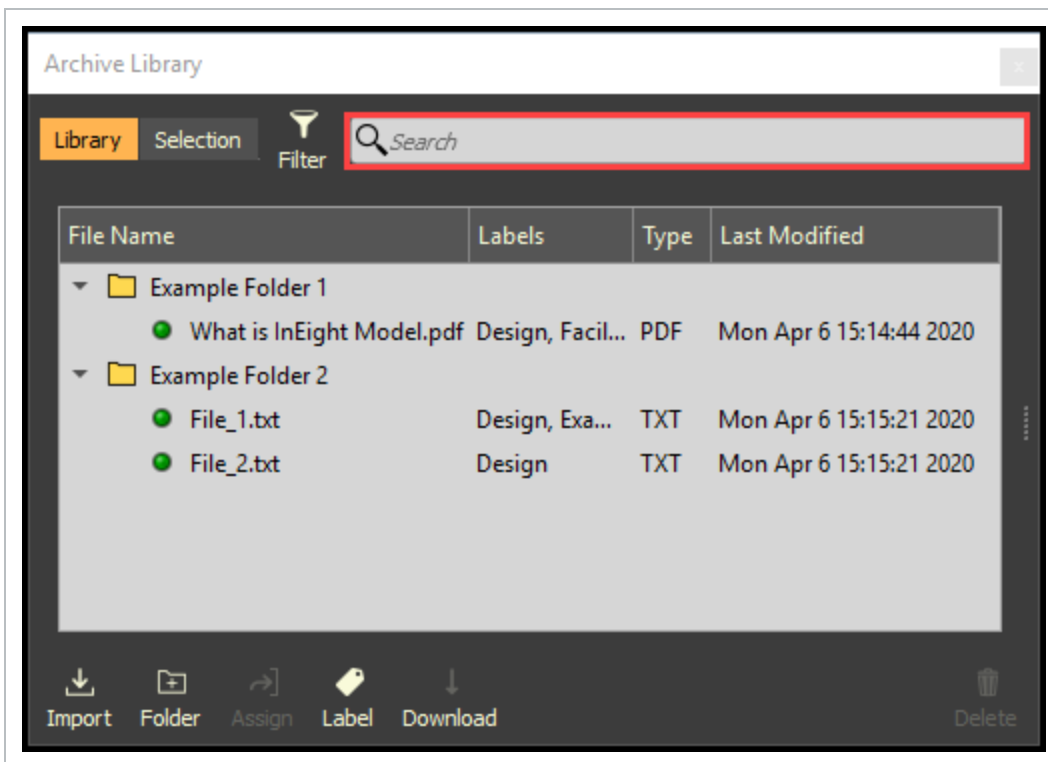

6.3 CREATE AND MANAGE LABELS

Labels can be utilized to quickly group and filter files. Multiple labels can be assigned to files.

6.3 STEP BY STEP 1 – CREATE AND APPLY A LABEL TO A DOCUMENT

1. Select one or more documents.
2. Click the **Label** icon.
 - Or, right click and select **Label Selected**

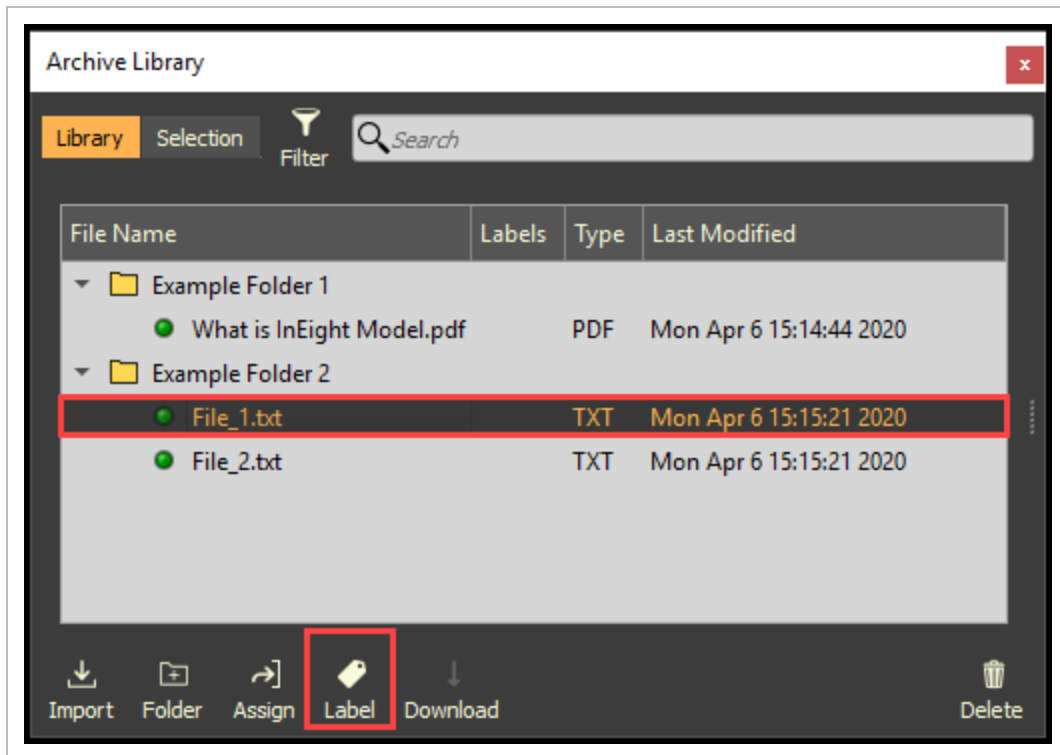

- The Add or remove labels dialog box will open
3. Type in a name, then click **Add**.

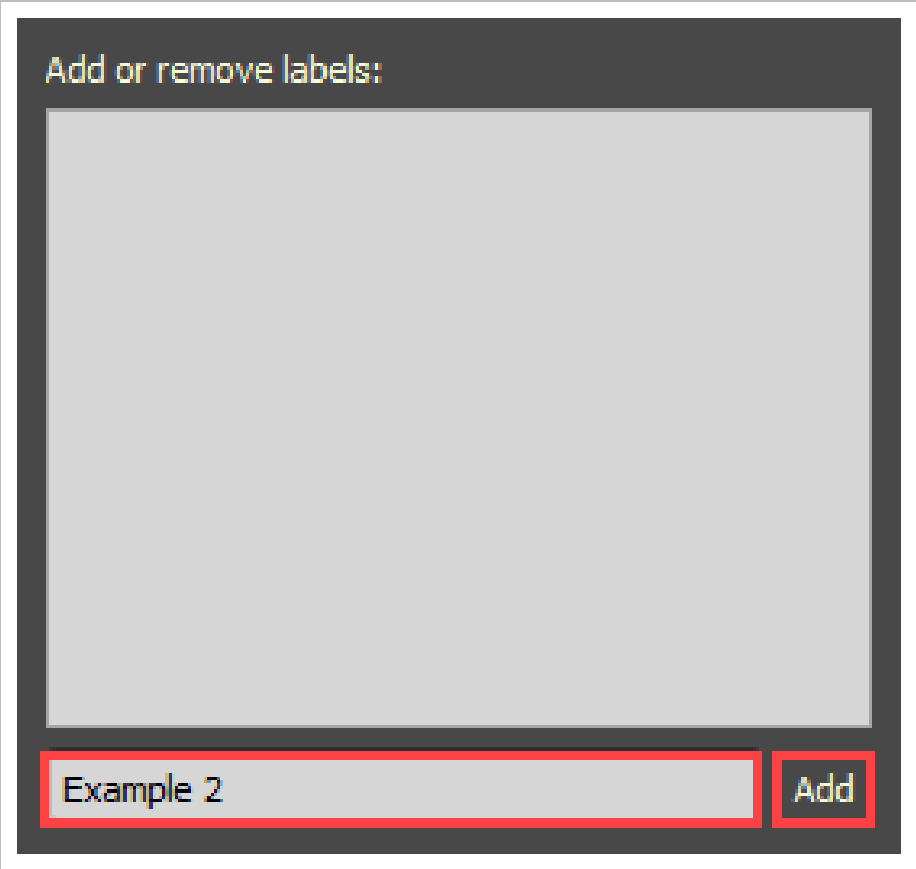

- The Label dialog box will stay open and show a checked box with a new label

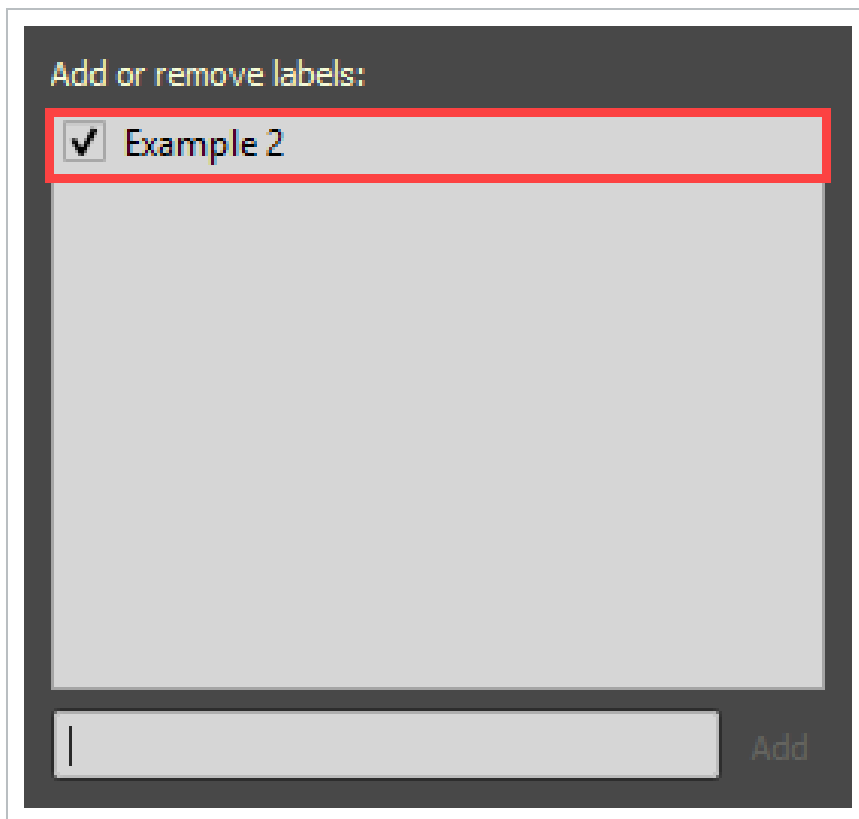

NOTE Labels only display in the Add or Remove Label dialog box if they have been applied to document. Once a label has been removed from all documents, it will no longer appear in the Add or Remove Label dialog box.

1. Select anywhere outside of the Label dialog box to close it and apply the checked label.

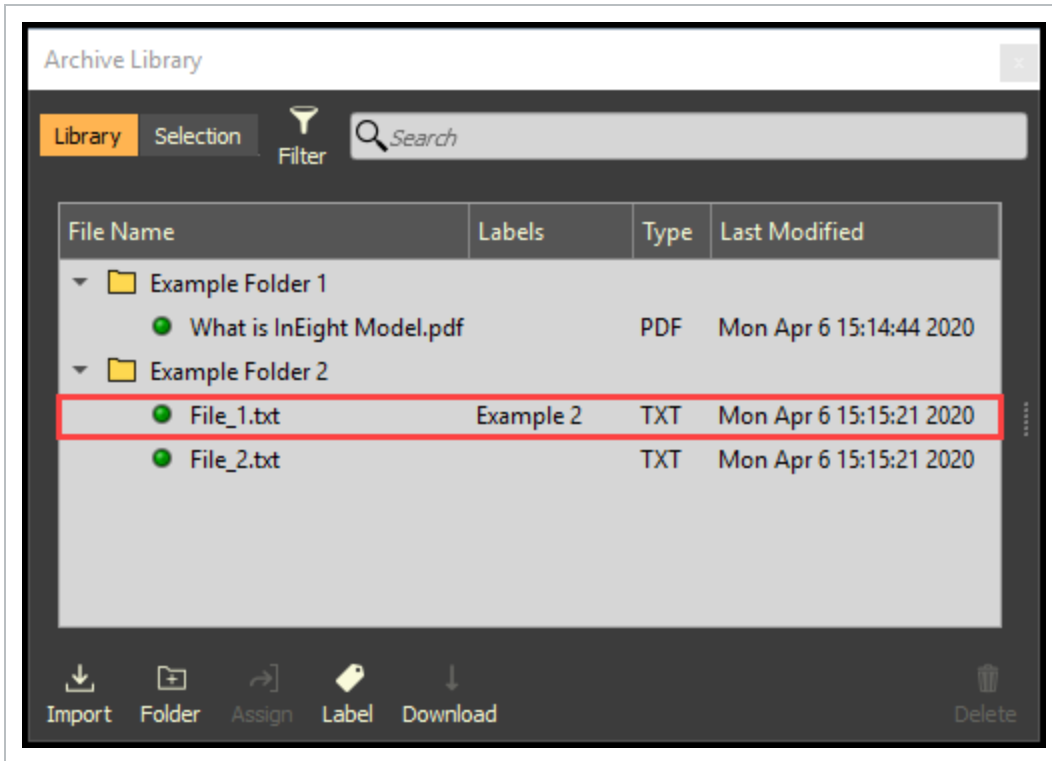

6.3 STEP BY STEP 2 – APPLY AN EXISTING LABEL TO A DOCUMENT

1. Select one or multiple documents.
 - And/Or select one or more folders
2. Click the **Label** icon.
 - Or right click and select **Label Selected**

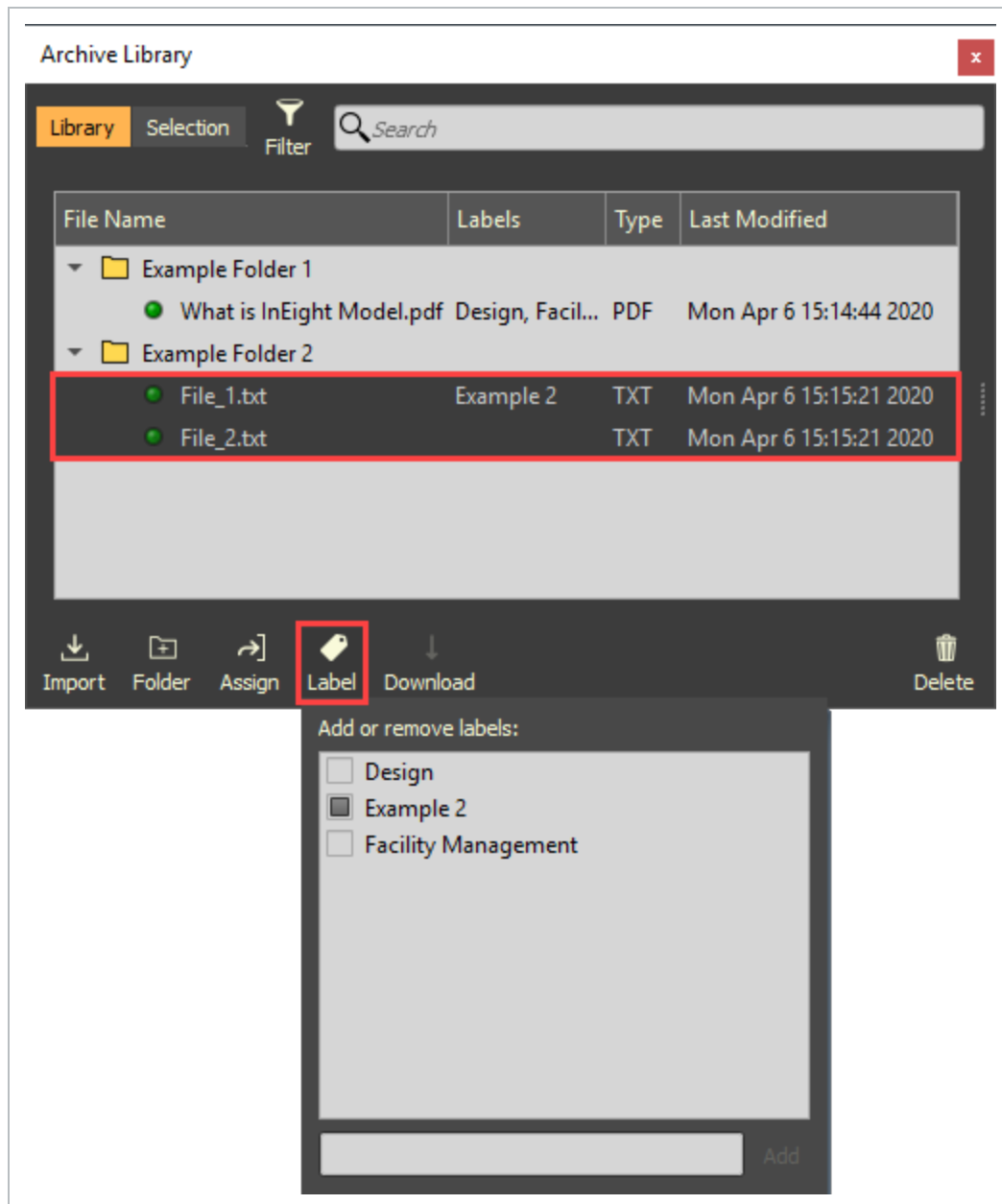

3. Select the desired labels to apply to the selected documents.
4. Select anywhere outside of the Label dialog box to close it and apply the checked label(s).

6.3 STEP BY STEP 3 – APPLY OR REMOVE LABELS WITHIN THE DOCUMENT INFO AREA

1. Select one or multiple documents.
2. With the mouse on top of the slider bar, click and slide the advanced panel open.

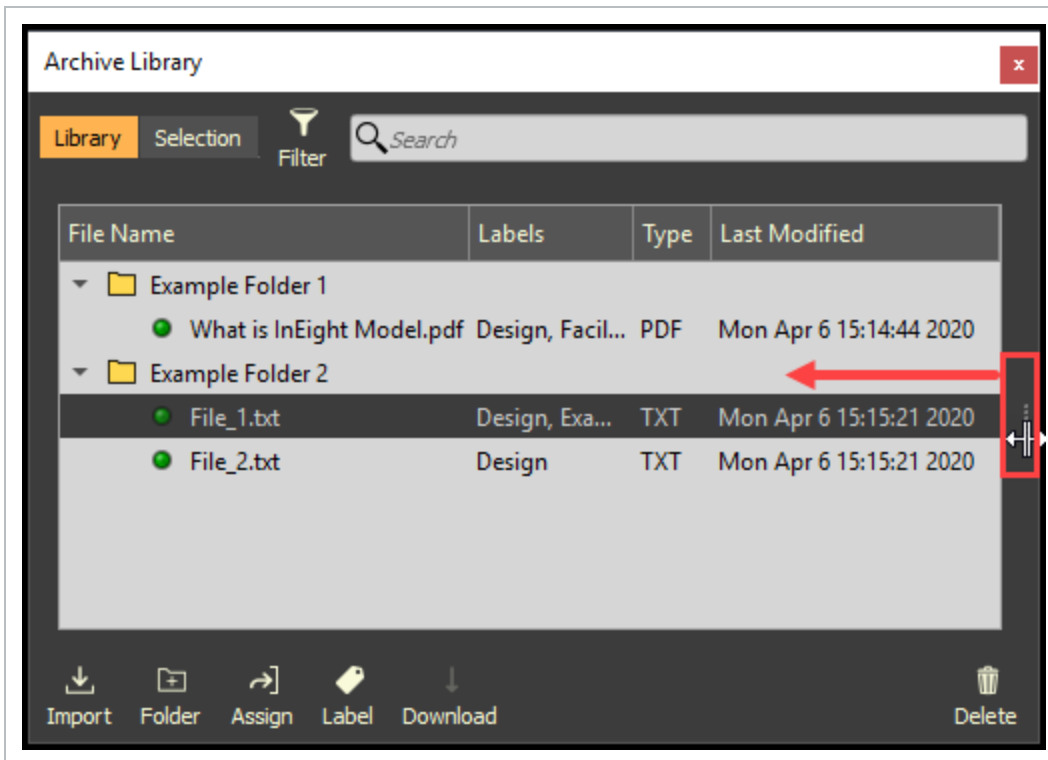

- Manage labels within the **Labels** tab

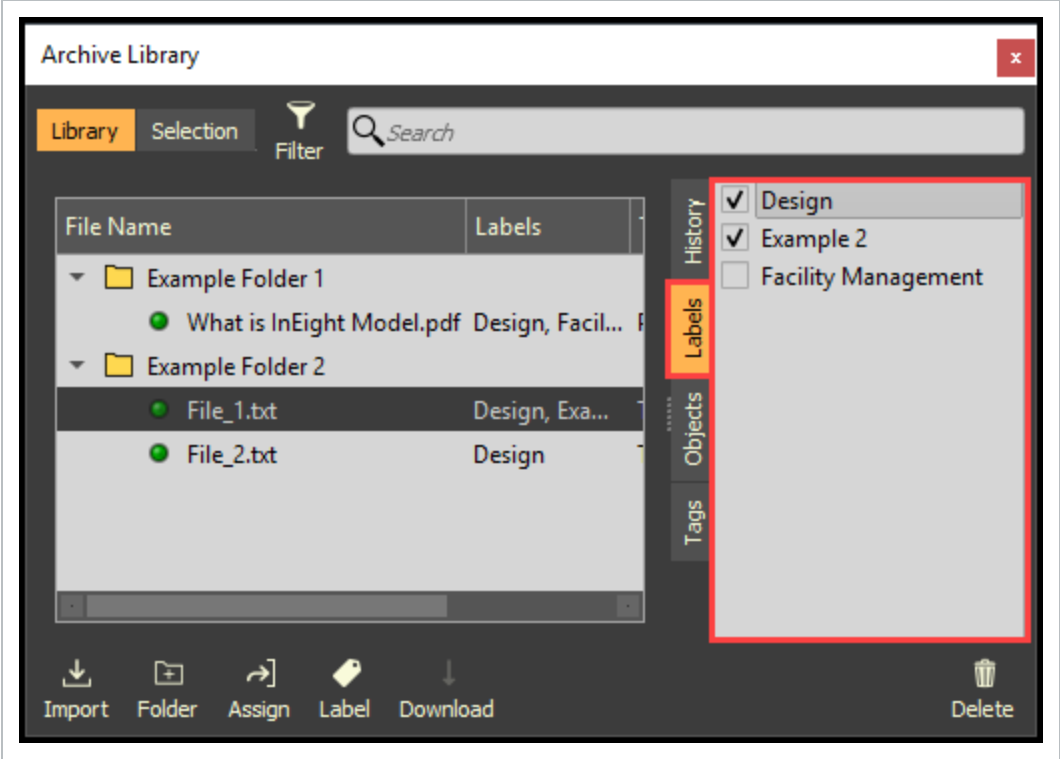

6.3 STEP BY STEP 4 – FILTER DOCUMENTS BY LABELS

1. Select the **Filter** icon.

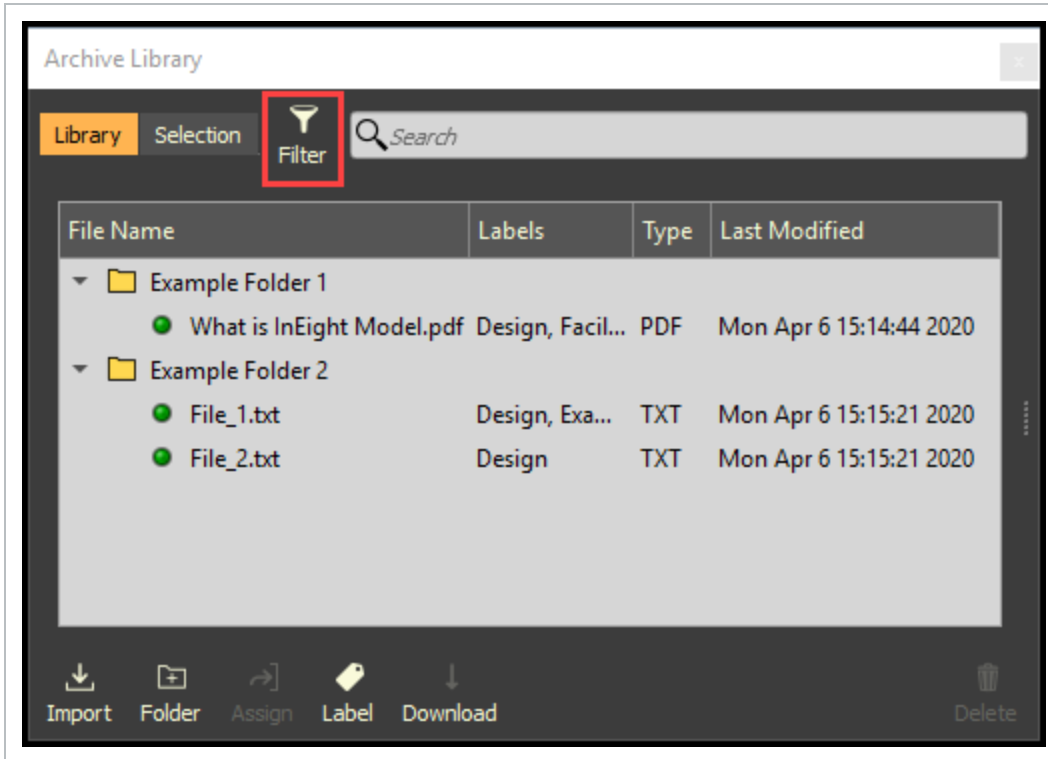

- The Filter Criteria dialog box opens

NOTE

The Filter Criteria is configured as an ALL criteria. The documents are filtered as ALL criteria is met within the Filter Criteria dialog box.

Filter Criteria

Has Label:

- All
- Unlabeled
- Facility Management
- Design
- Example 2

Status:

All

Upload Date:

Is Before

4/8/2020 4/8/2020

Uploaded By:

Any

File Type:

Any

Clear

- **Has Label:** Filter documents according to checked labels
- **Status:** Filter documents according to their status (All, Unlinked Docs, Not Downloaded, or Downloaded)
- **Upload Date:** Filter documents according to Uploaded Date criteria
- **UploadBy:** Filter documents according to who uploaded the documents
- **FileType:** Filter documents by file type
- **Clear:** Clear

6.4 LINK AND MANAGE DOCS TO TAGS

Documents can be linked directly to model object tags. Linking documents provides a convenient way to quickly access applicable documents by selecting model content within the 3D Viewer window.

6.4 STEP BY STEP 1 – LINK DOCUMENTS TO TAGS

1. Within the Tags and Objects panel, select a **Tag Value** (i.e. Pile).

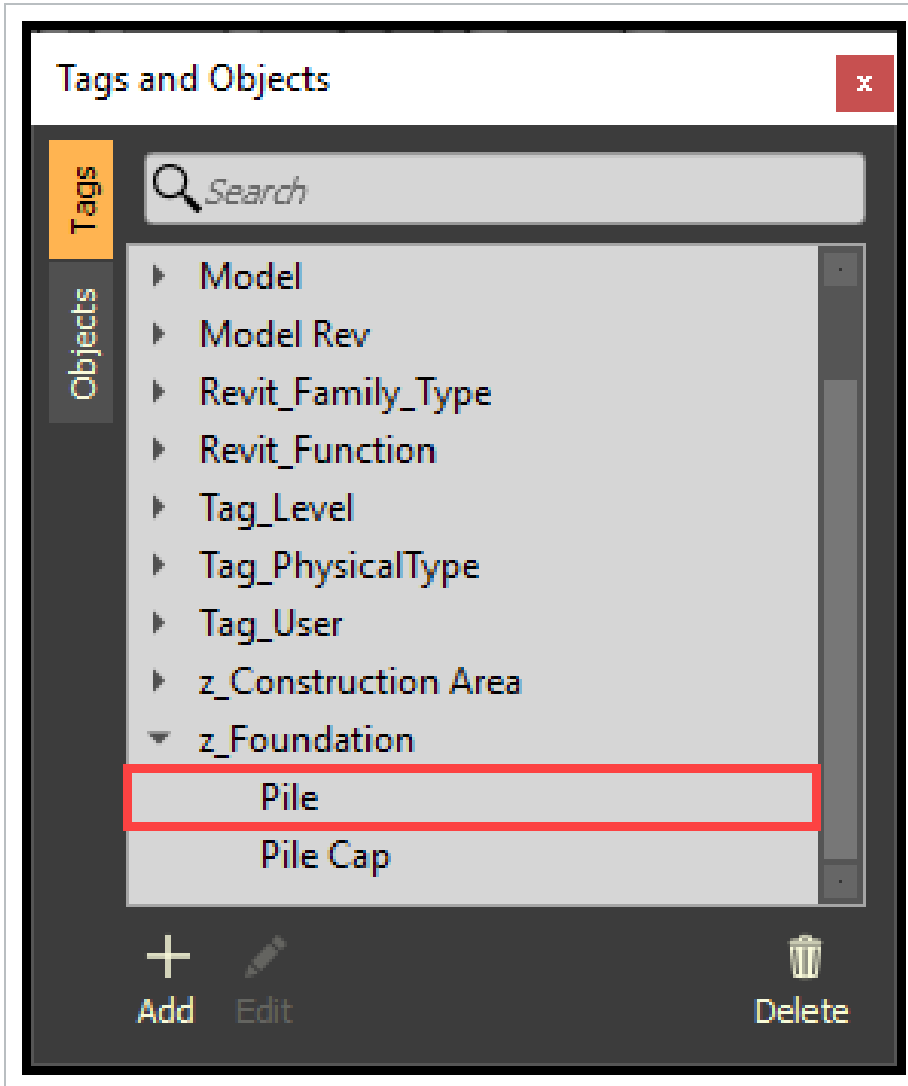

2. Within the Archive Library panel, select one or multiple documents.
3. Click the **Assign** icon.

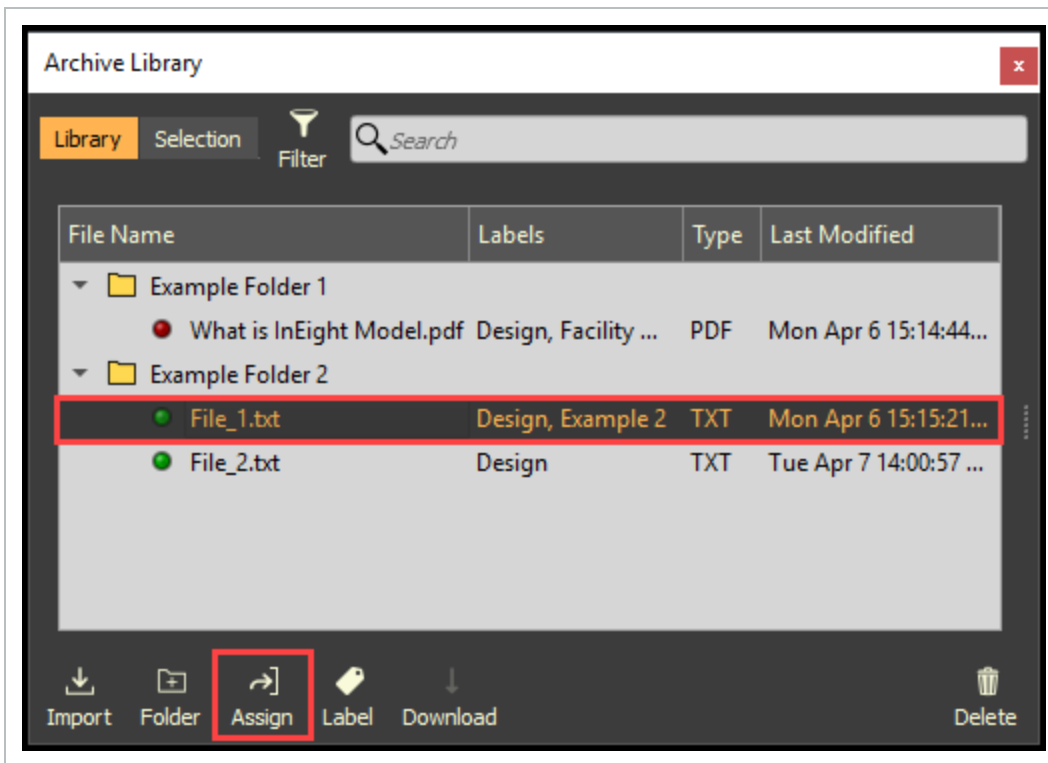
**TIP**

Drag and drop a document onto a Tag Value within the Tags and Objects panel.

6.4 STEP BY STEP 2 – ASSOCIATE A SPECIFIC PAGE WITHIN A PDF DOCUMENT TO A TAG

After a PDF document has been linked to one or more model object tags, a specific page within the PDF can be associated to the link, so that, when the document is opened via the link, it will open to the associated page.

1. Select a PDF document that has been associated to a tag.
2. Open the Document Information window.

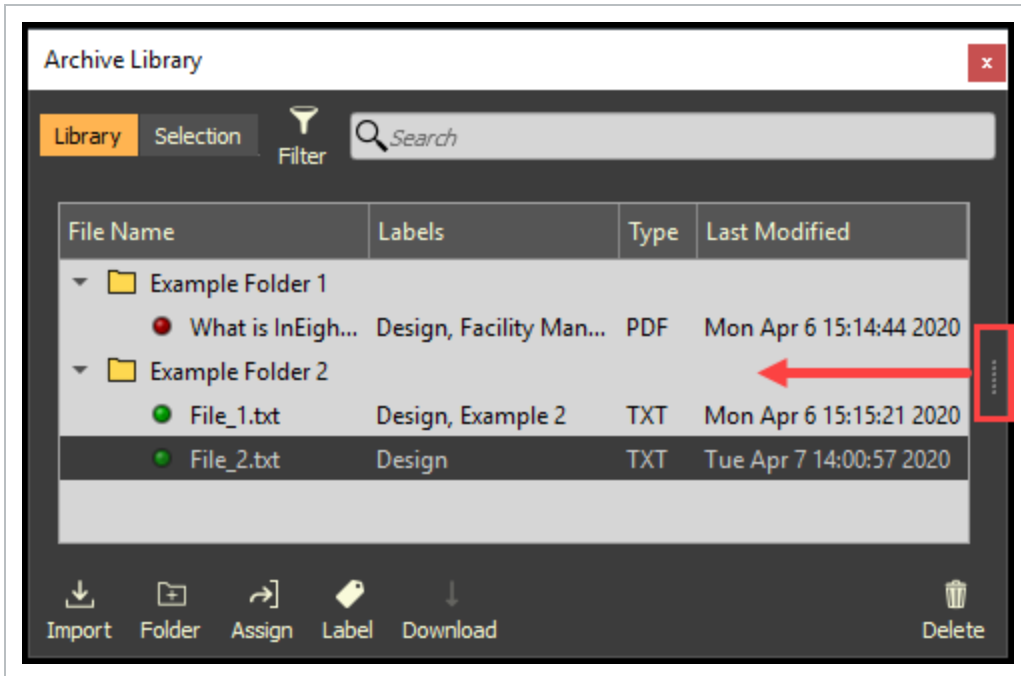

3. Double click on the **page number**, then type in the desired page number.

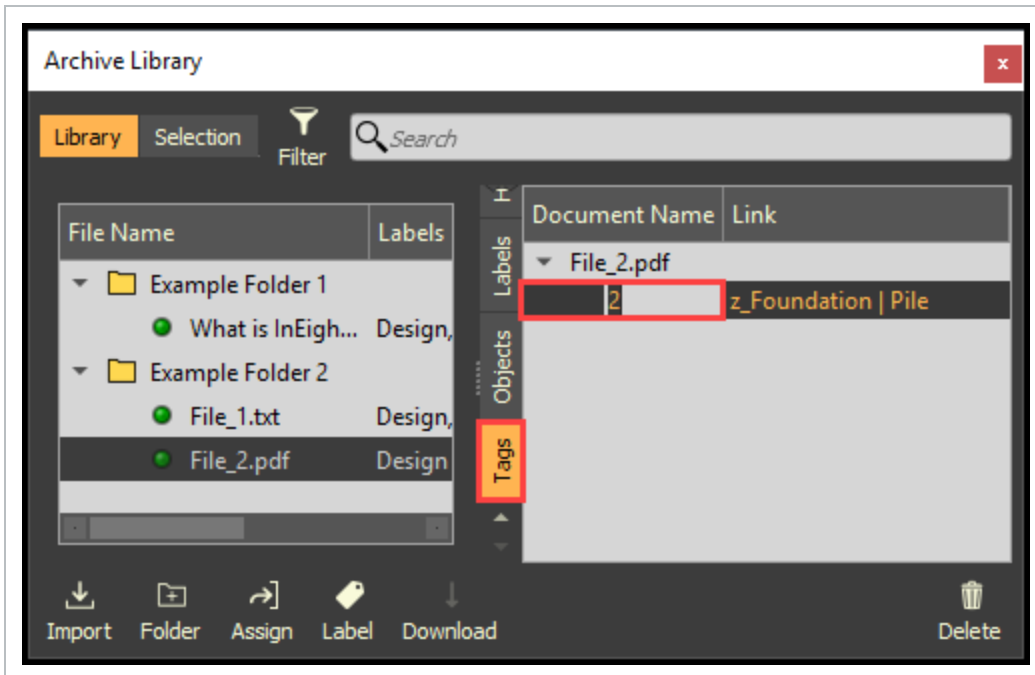

6.4 STEP BY STEP 3 – VIEW AND/OR REMOVE AN OBJECT TAG LINK VIA THE DOCUMENT INFORMATION WINDOW

1. Select a document.
2. Open the Document Information window.

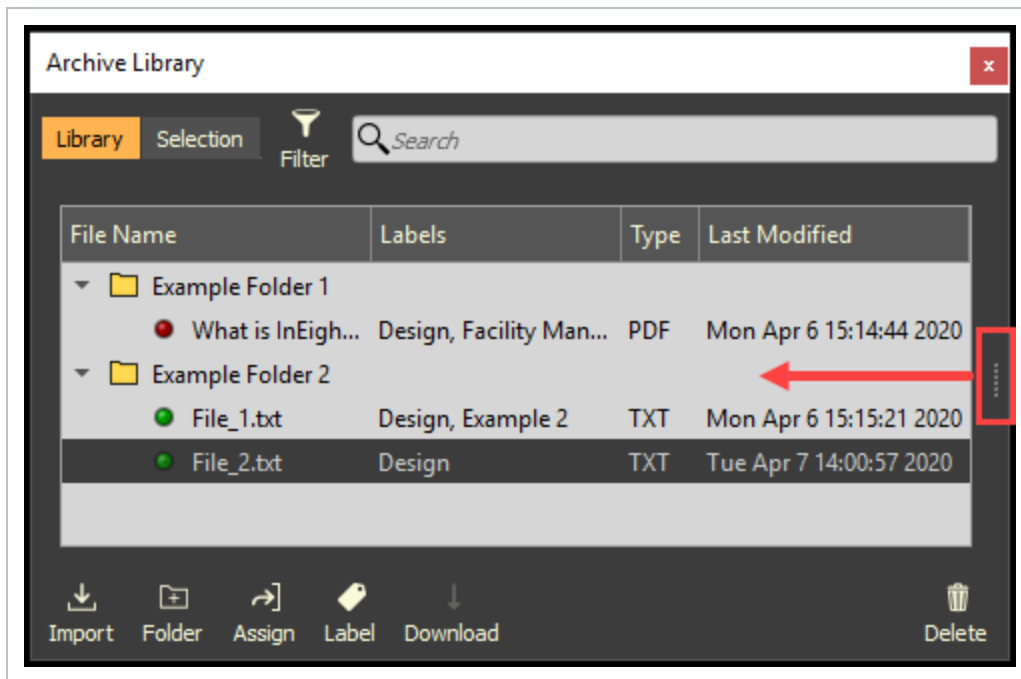

3. Select the **Tags** tab.
4. Select the **Tag Link** to view the linked model object.
5. Right click and select **Remove Tag Link** to remove the link.

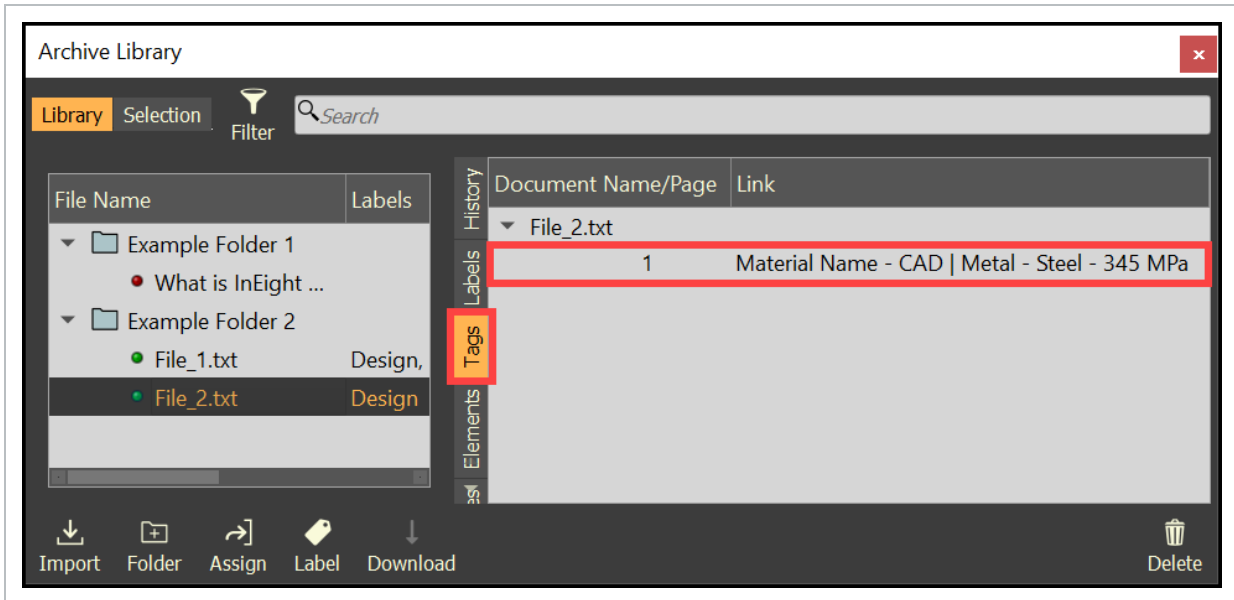

6.4 STEP BY STEP 4 – VIEW AND/OR REMOVE A DOCUMENT LINK VIA THE SELECTION TAB

The Selection tab within the Archive Library displays all documents linked to the Actively Selected Model Objects.

1. Select one or multiple model objects or a tag.
2. Within the Archive Library, select the **Selection** tab.
3. View associated document content by double clicking on the document.

4. To remove a link, select a document from the list, then click on the **Unassign** icon.

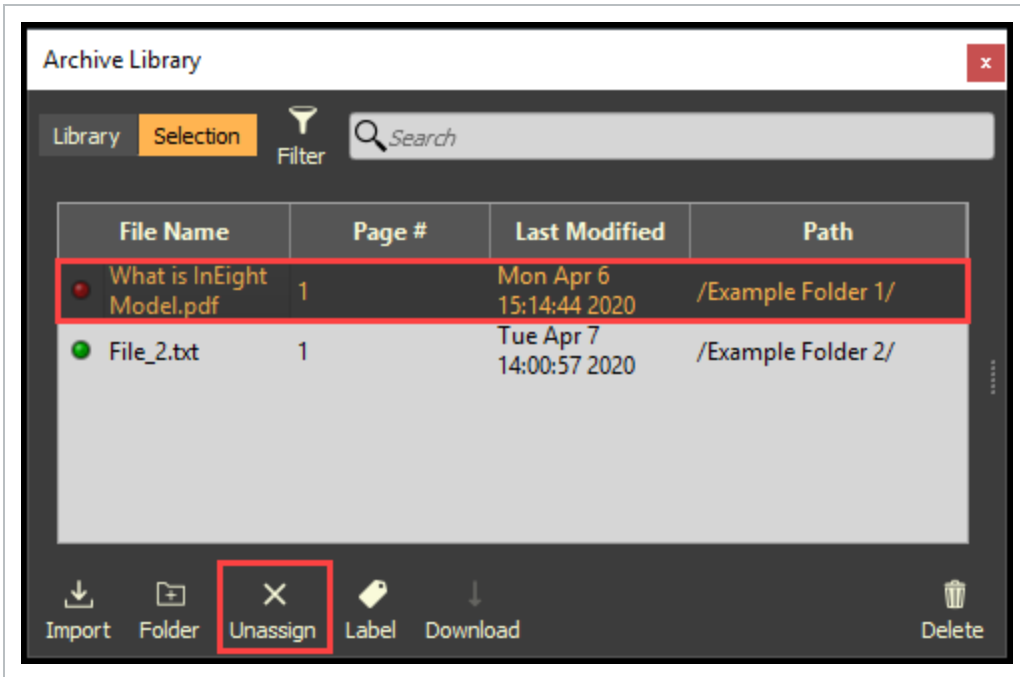

LESSON 6 REVIEW

1. You can view all project documents from the _____ tab of the Archive Library.
 - a. Objects
 - b. Tags
 - c. Selection
 - d. Library

2. You can only link a document to one object.
 - a. True
 - b. False

3. You can download documents from a model to keep on your desktop.
 - a. True
 - b. False

LESSON 6 SUMMARY

As a result of this lesson, you can:

- Import and manage documents
- Link documents to objects and tags
- Link specific pages
- View documents within InEight Model

This page intentionally left blank.

CHAPTER 7 – SELECTION INFO

7.1 SELECTION INFO OVERVIEW

The **Selection Information panel** displays attribute data of actively-selected model objects. The displayed attribute data will change accordingly to the actively-selected model objects. The tabs within the Selection Information panel displays grouped attribute data. If there are no model objects selected, then the Selection Information panel will be blank.

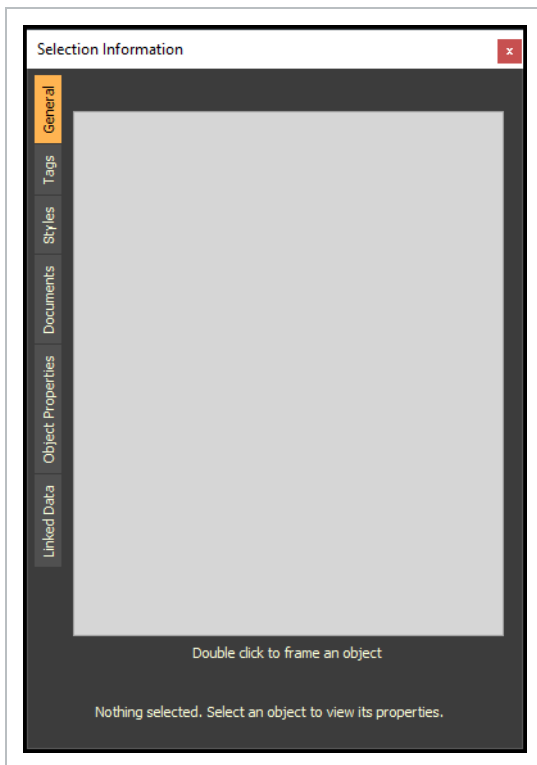

7.1.1 SELECTION INFORMATION PANEL

To access the Selection Information panel, select **Object** from the menu bar at the top left of the screen. Then, select **Selection Information**.

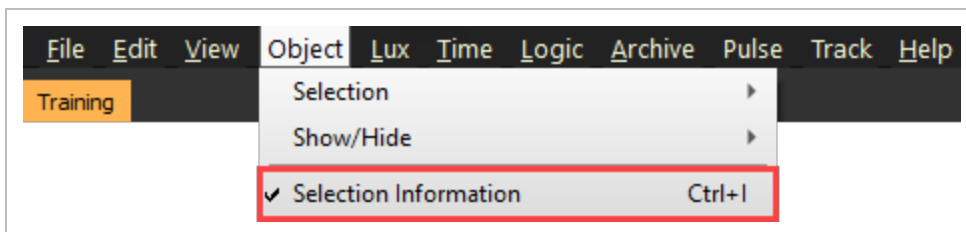

7.1.2 GENERAL TAB

The **General tab** displays the Model Stream name of the selected objects, the Material Name – CAD tag value for each model object selected, the total surface area, the total volume, and the total number of objects currently selected.

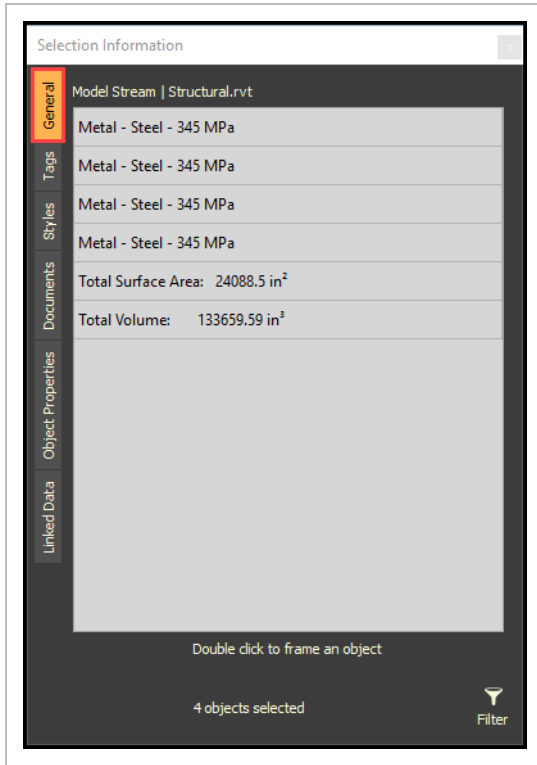

7.1.3 TAGS TAB

The **Tags tab** displays all metadata for the selected objects, the number of objects per metadata, and the total number of objects currently selected.

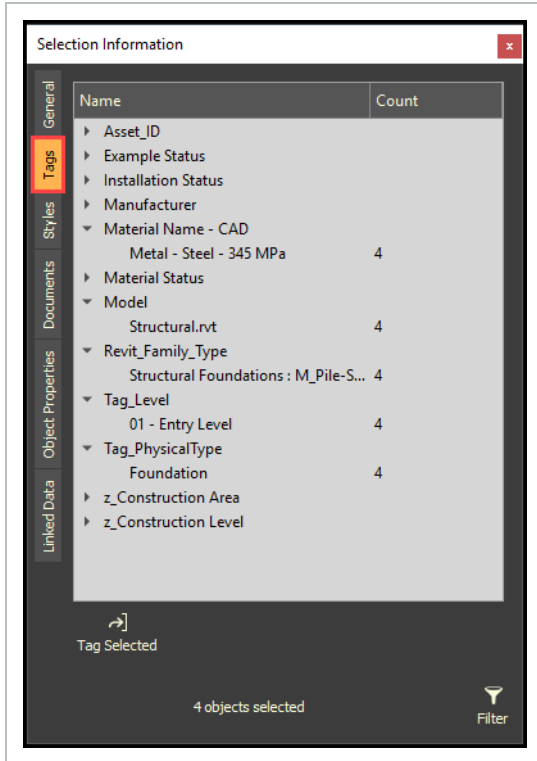
**NOTE**

There are additional actions that can be taken within the Tags tab: Filter the Selection, Select similar tags, and Tag Selected objects with a new tag.

- **Select Tag** - Right Click on a tag value, then click Select Tag to select all objects with the same tag

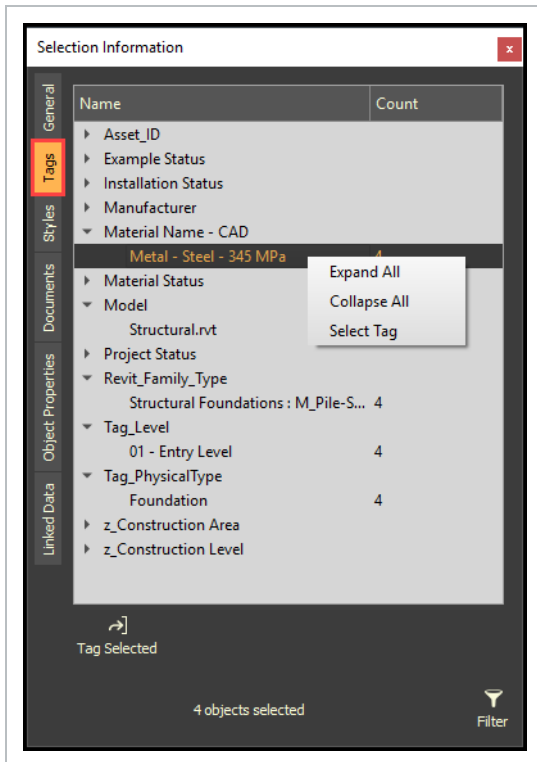

- **Tag Selected** - Click the Tag Selected icon to open the Create Tag dialog box

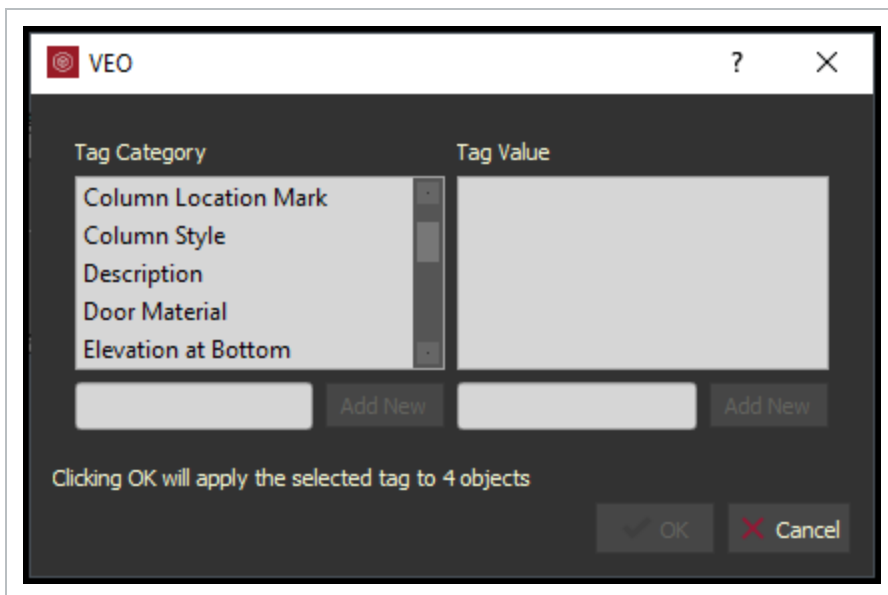

7.1.4 STYLE TAB

The **Style tab** displays all the styles associated with the selected object.

NOTE The Style tab will not display information when multiple objects are selected.

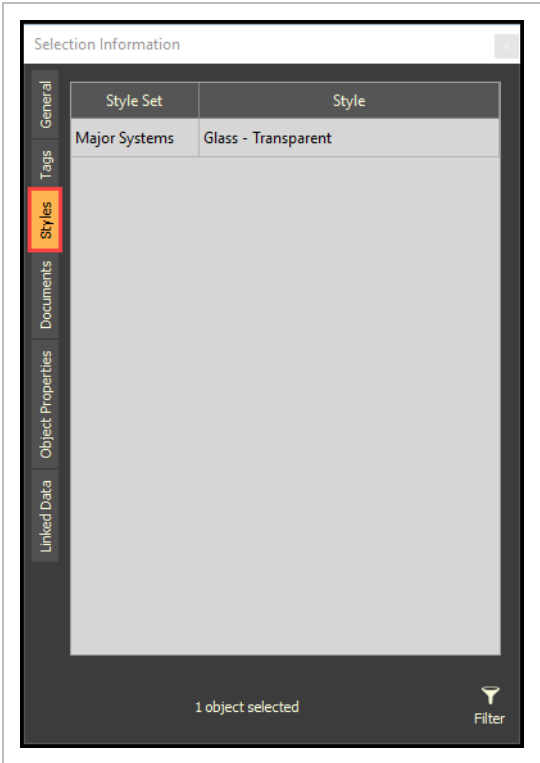

7.1.5 DOCUMENTS TAB

The **Documents tab** displays the documents associated to the selected objects.

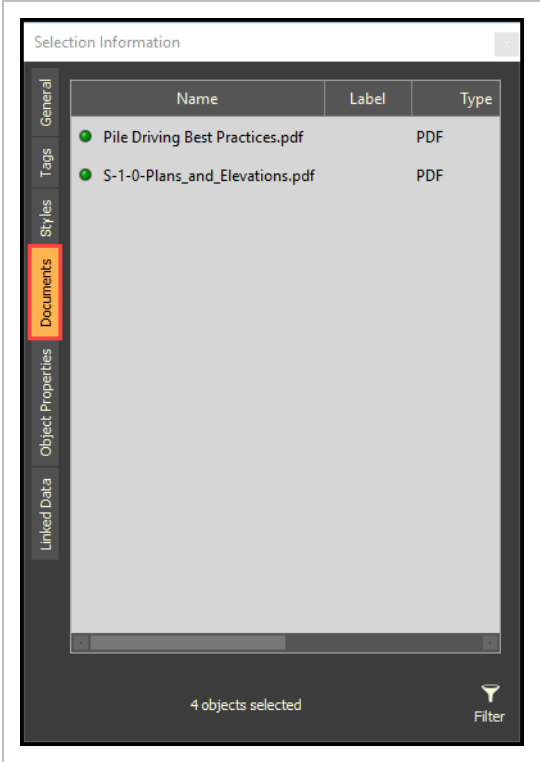

NOTE There are additional actions that can be taken within the Documents tab: Filter the Selection, Open the Documents, or Reveal the documents in Archive Library.

Right Click on a document for additional actions.

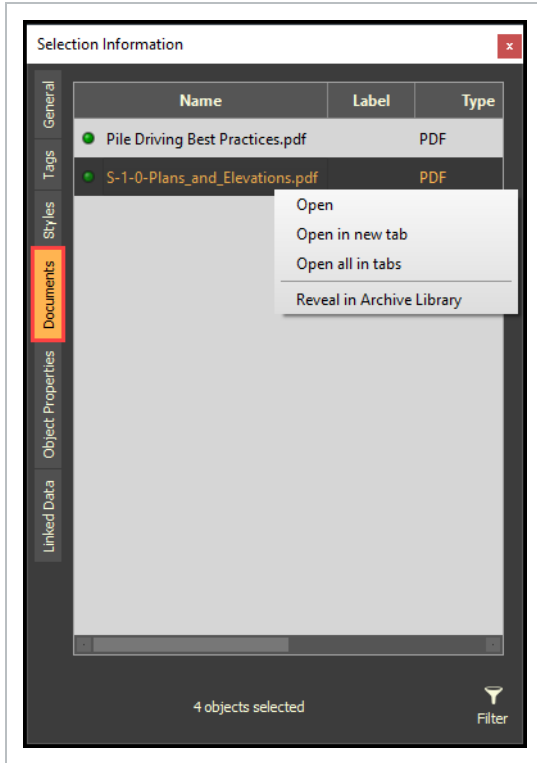

7.1.6 OBJECT PROPERTIES TAB

The **Object Properties tab** displays only the metadata that was selected as Object Property during the Model Stream Export/Import process.

**NOTE**

There are additional actions that can be taken within the **Object Property tab**: Filter the Selection and toggle a Parameter as a favorite. The favorited Parameters will appear at the top of the list.

7.1.7 LINKED DATA

The **Linked Data tab** can be associated to Record Tables created within InEight Compliance.

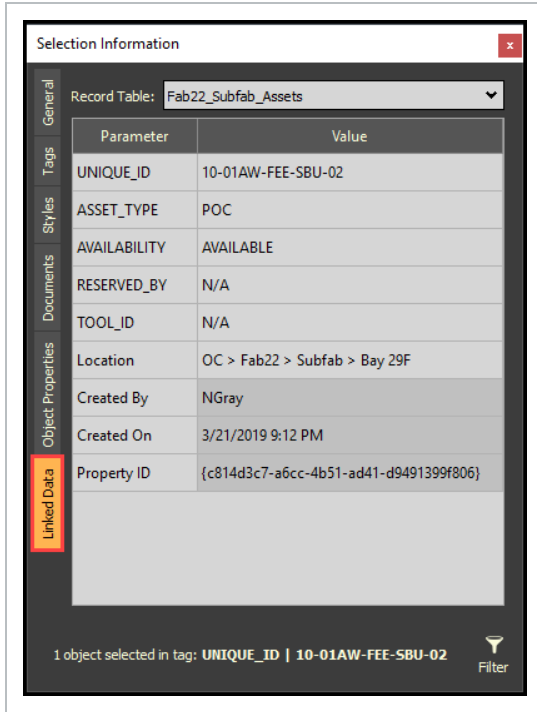

7.1.7.1 SELECTION FILTER

The **Selection Filter** can be launch by clicking on the Filter icon from any of the tabs. Then uncheck any of the Enable check boxes to fine tune your selection.

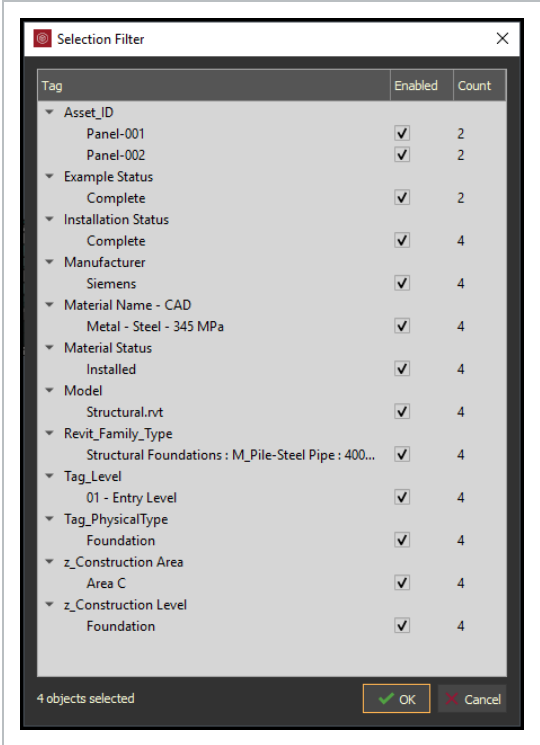

LESSON 7 REVIEW

1. Which of the following is NOT a tab on the Selection Information panel?
 - a. Object Properties
 - b. Documents
 - c. Coordination
 - d. Linked Data
-

LESSON 7 SUMMARY

As a result of this lesson, you can:

- Navigate the Selection Information panel

CHAPTER 8 – SECTIONING

8.1 SECTIONING OVERVIEW

Sectioning lets you isolate a certain section or area of a project to easily visualize model content. Adjust the Sectioning box in the 3D viewer by managing the Top, Bottom, Left, Right, Front, and/or Back planes of the box.

TIP

When the mouse cursor moves through the Sectioning panel a yellow outline is shown along with a corresponding yellow line in the 3D view indicating the current edge of the section.

8.1.1 SECTIONING PANEL

To access the Sectioning panel, select **View** from the menu bar at the top of the screen. Then, select **Sectioning**.

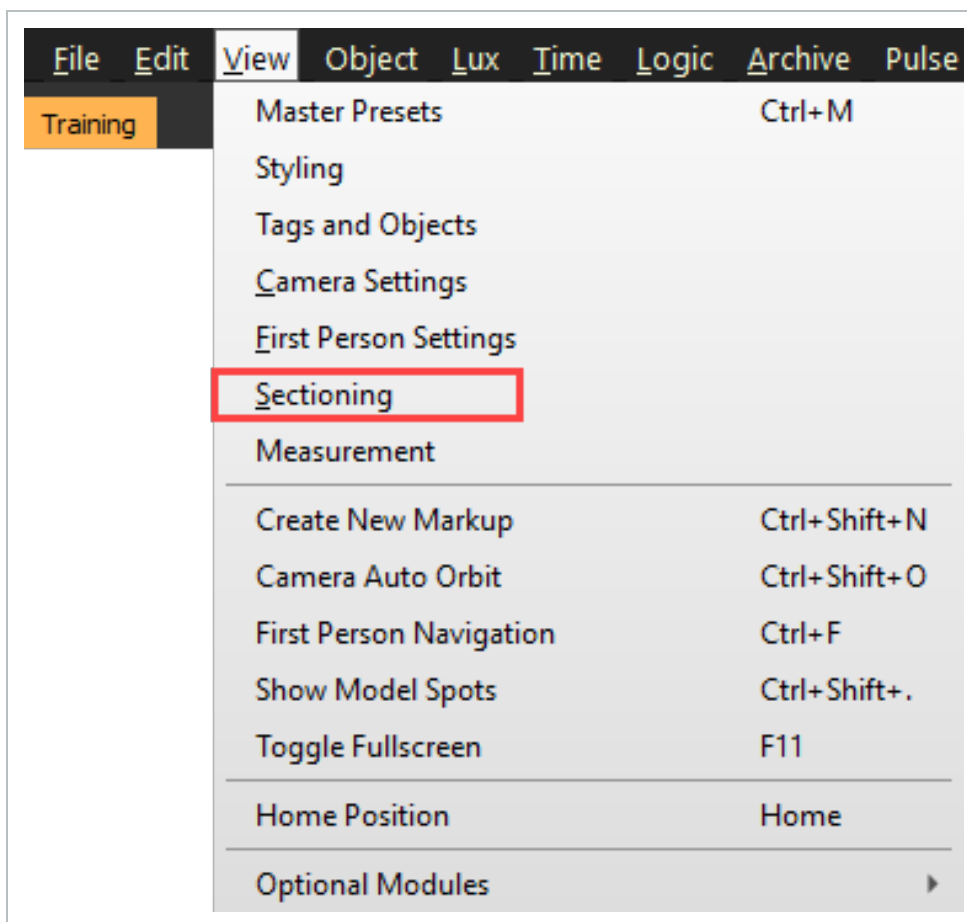

This opens the Sectioning Panel.

Toggle **OFF** to **ON** to initiate a section box. Toggle **HIDE** to **SHOW** to see the section box in the 3D View.

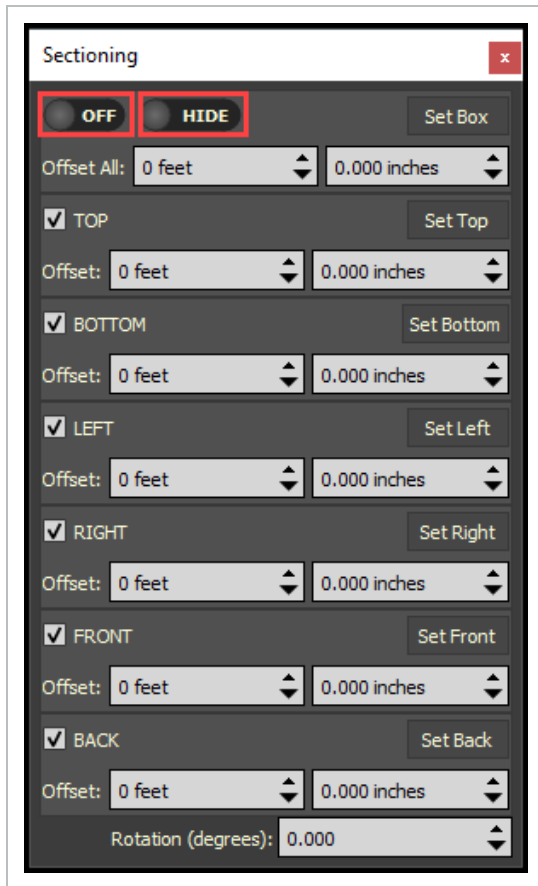

- **Set Box** - Sets the entire section box to the selected objects boundary. Or if no objects are selected, then it resets the section box to the model boundary.
- **Offset / Offset All** - Adjusts the section box according to the entered criteria.
- **TOP / BOTTOM / LEFT / RIGHT / FRONT / BACK** - Can be enabled and can be set according to selected objects or no objects selected. If objects are selected, then the section is set to the object boundary. If no objects are selected, then the section is set to the model boundary.
- **Rotation** - Rotates the section box.

8.1.2 SECTIONING ICON

Sectioning can also be switched **ON** or **OFF** with a left mouse click on the **Section icon** located at the bottom left of the screen. Switch **SHOW/HIDE**, and launch the **Sectioning Panel** with a right click on

the icon.

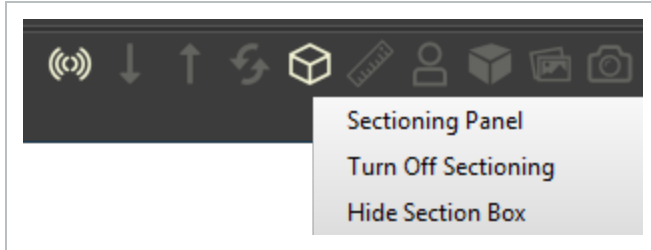

8.2 CREATE AND APPLY SECTIONING

Sectioning can be applied in different ways to yield desirable results.

8.2 STEP BY STEP 1 – APPLY SECTIONING USING THE SET BOX

1. Switch Sectioning **ON**.
2. To see the sectioning box in the 3D viewer, toggle **SHOW**.



3. Select a model object or a tag.

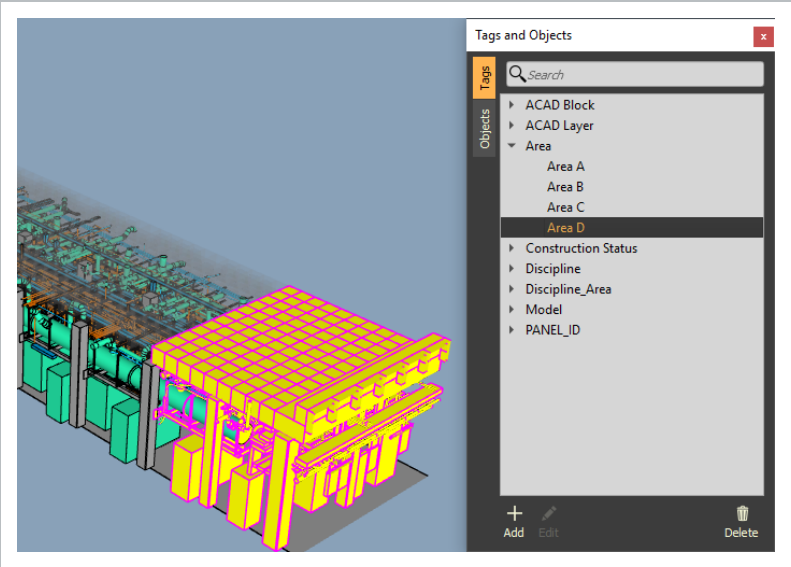

4. Click the **Set Box** icon.



- The Sectioning box has been set to the model objects boundaries

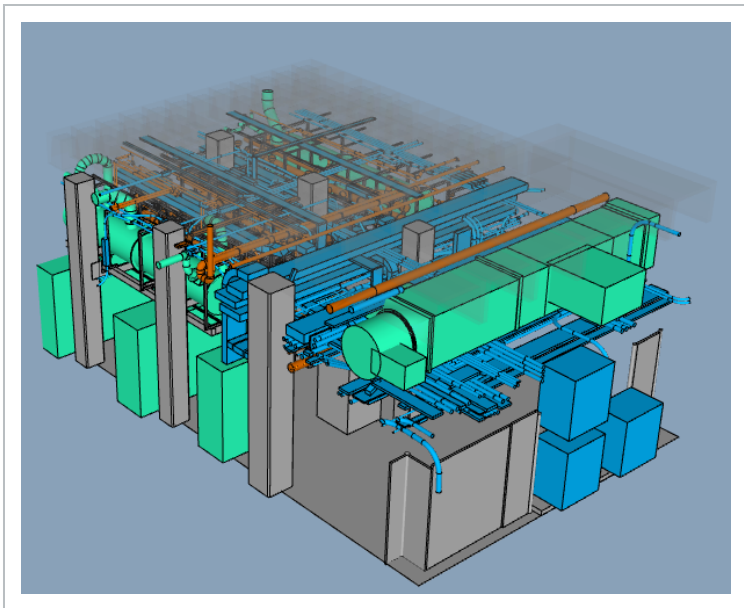

8.2 STEP BY STEP 2 – APPLY SECTIONING BY DRAGGING AND DROPPING A TAG

1. Switch Sectioning **ON**.
2. From the Tags and Objects Panel, select a tag.
3. Drag and drop the tag onto a section part in the Sectioning Panel.

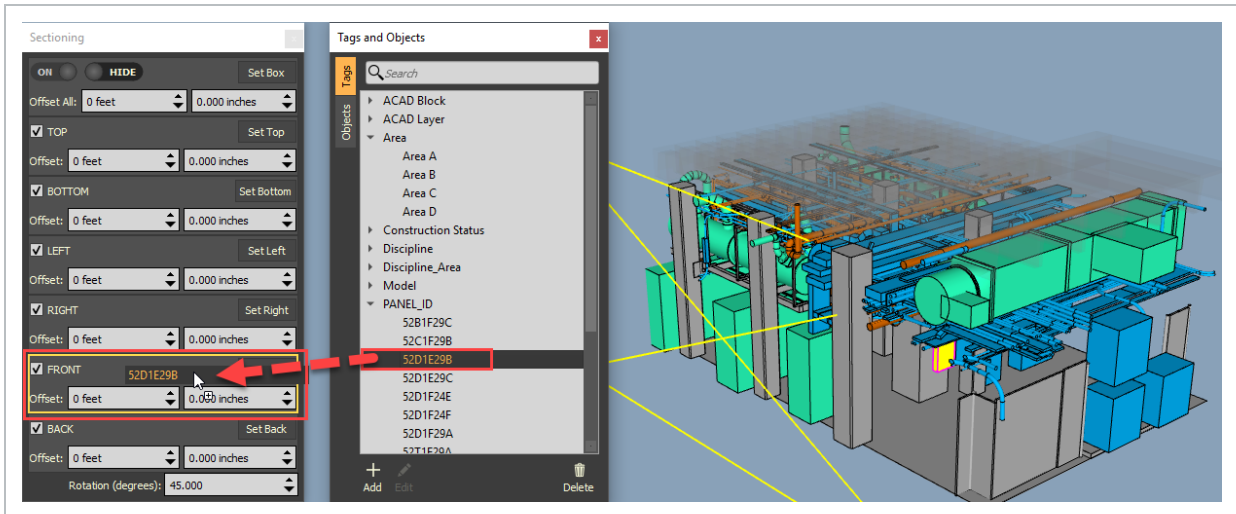

8.2 STEP BY STEP 3 – APPLY SECTIONING BY THE OFFSET

1. Switch Sectioning ON.
2. With the mouse over an Offset field, scroll the mouse wheel to set a numeric offset
3. Or type in the preferred numeric offset.

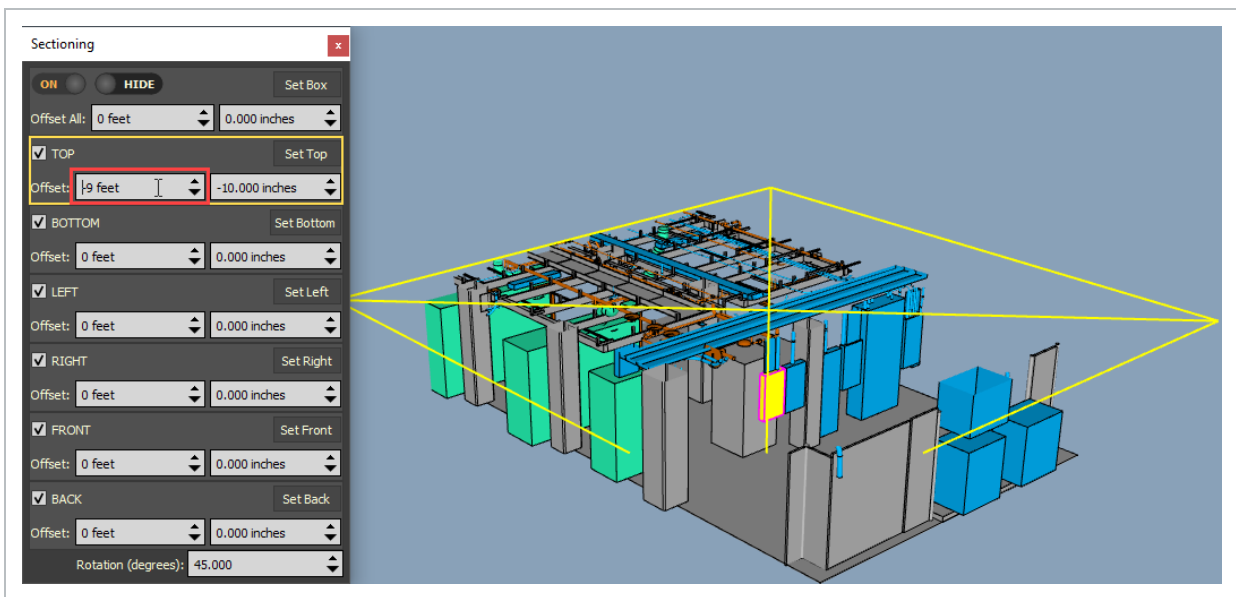

8.2 STEP BY STEP 4 – MOVE SECTIONING PANES WITH GRIPS

1. Switch Sectioning **ON**.
2. Switch Section Box **ON**.
3. Hold the **CTRL** key and hover over the sectioning panes to see them highlight.
4. Hold **CTRL + LMC** (left mouse) to move a sectioning pane.

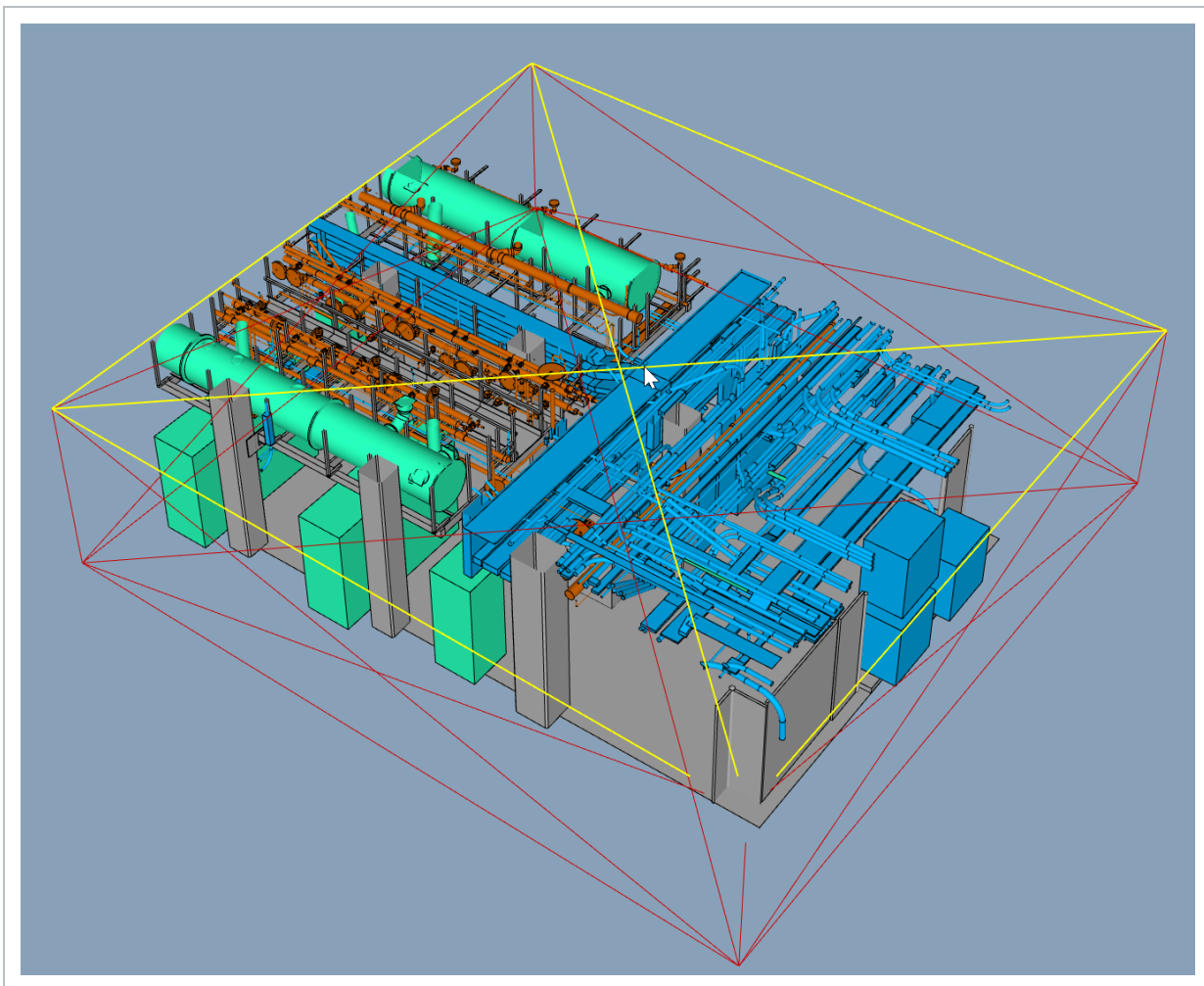

8.2 STEP BY STEP 5 – RESET THE SECTIONING BOX TO MODEL BOUNDARY

1. Switch Sectioning **ON**.
2. Ensure no model object is selected.
3. Click the **Set Box** icon.

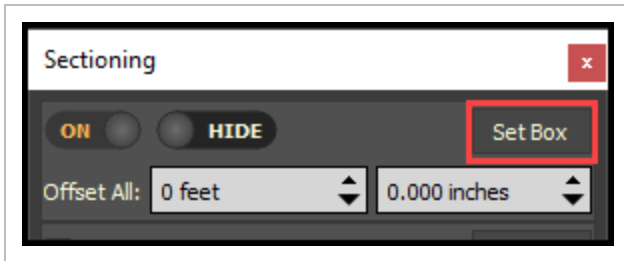

NOTE

Any of the Section Parts can be reset individually by ensuring that no model objects are selected, then select the specific Section part Set icon (that is, Set Top).

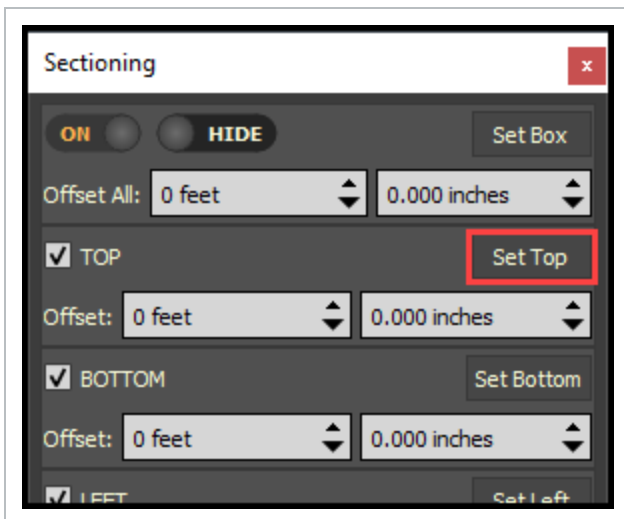

8.2 STEP BY STEP 6 – USE SECTIONING WITH MASTER PRESETS

1. Switch Sectioning **ON**.
2. Adjust the Sectioning as desired.
3. In the Master Preset Editor, click **Sectioning**.

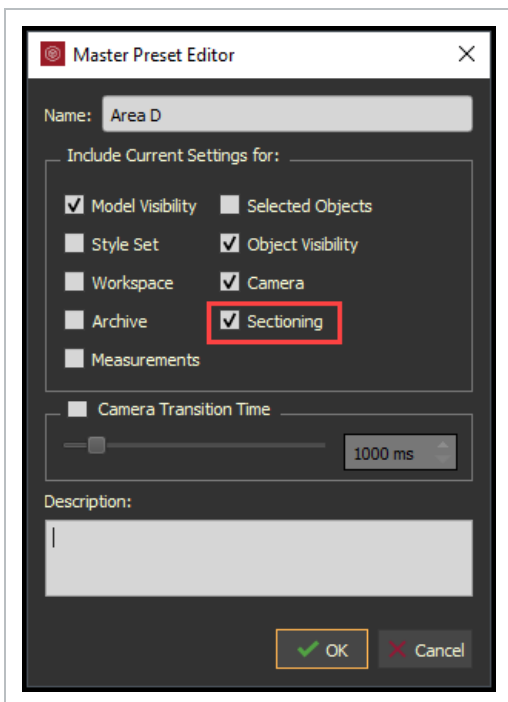

LESSON 8 REVIEW

1. You can quickly access sectioning from the Sectioning icon on the menu in the bottom, left.
 - a. True
 - b. False

2. You can apply sectioning to master presets.
 - a. True
 - b. False

LESSON 8 SUMMARY

As a result of this lesson, you can:

- Apply sectioning using the set box
- Apply sectioning by dragging and dropping a tag
- Apply sectioning by the offset
- Reset the sectioning box to model boundary
- Use sectioning with master presets

This page intentionally left blank.

CHAPTER 9 – MEASUREMENTS

9.1 MEASUREMENTS OVERVIEW

The Measurements module lets you enter values to view your model in 3D and then save the values in a folder for reference and use later. You must select a measure Mode to take measurements.

9.1.1 MEASUREMENT WINDOW

To access the Measurements window, select View > **Measurement**. The Measurement window opens.

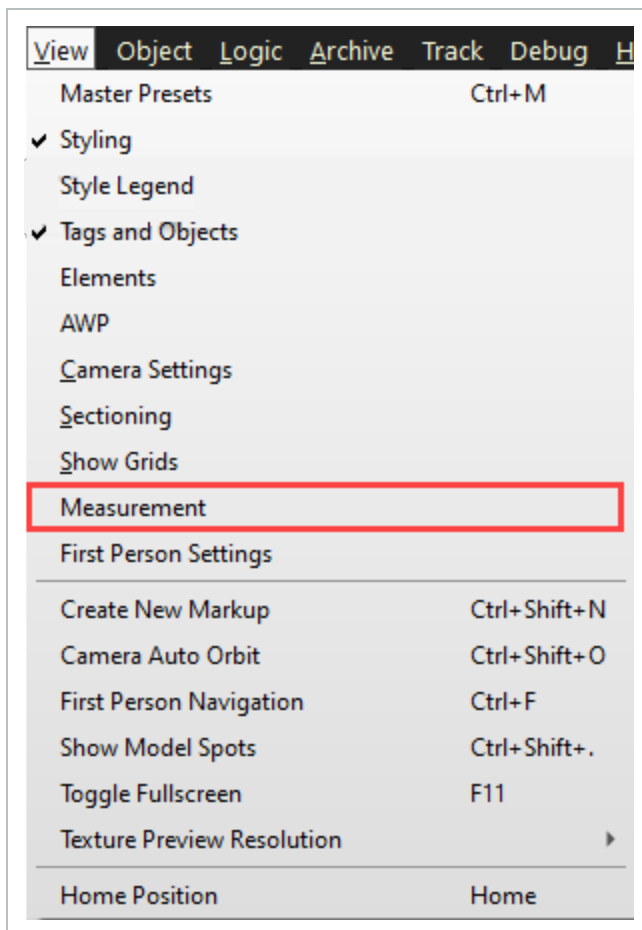

The Measurement window has six sections as shown below:

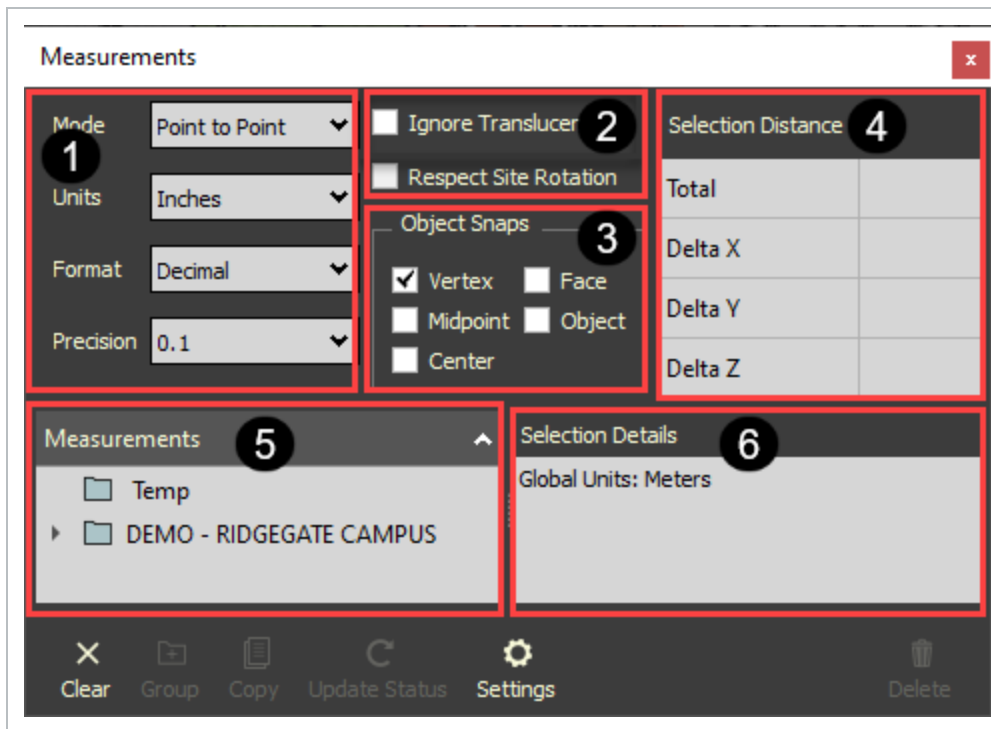

1 Measurement settings - Measurement settings - You can manage the mode, units, format, and precision of a measurement.

- **Mode** - Select between different modes to take your measurements:
 - **Point to Point** - Basic Point A to Point B measurement.
 - **Continuous** - Lets you continuously measure along a series of chosen points. Double-click on the last point to end the continuous measurement.
 - **Area** - Select a series of points that define an enclosed area. Close the area measurement by clicking on Point A. Points picked must be on the same plane.
 - **Angle** - Lets you pick three points to find an angle.
 - **Spot ID** - Select a point to show the X, Y, Z coordinates of the point. Spot IDs can be copied to clipboard.
 - **Units** - Select a unit to be shown when taking a measurement. Units are constrained according to the type of mode selected and will be denoted in italics and cannot be unselected.
 - **Format** - Select a format to show when taking a measurement. Formats are constrained according to the type of mode that is selected and will be denoted in italics and cannot be unselected.
 - **Precision** - Select the best precision for your measurement.

2 Measurement options - You can adjust how the measurement tools interact with objects

and how measurements are calculated.

- **Ignore Translucent** - You can select or unselect the Ignore Translucent objects during measurement mode. When selected, translucent objects in the view window are ignored. This lets you indicate whether translucent objects, such as room, operation, or maintenance volumes are included in the model project. Measurements do not consider translucent objects.
- **Respect Site Rotation** - Measurement calculations are defined according to the Site Rotation Values defined on Model stream import.

3 Object Snaps - You can select one or multiple object snaps to define the selection type of taking a measurement. Face and Object are exclusive snaps and cannot be active at the same time.

- **Vertex** - Snap to any corner or endpoint.
- **Midpoint** - Snap to the middle of an edge.
- **Center** - Snap to the center of a face.
- **Face** - Snap to any face. The measurement is calculated according to the closest point between the face selected and the other objects involved in the measurement.
- **Object** - Snap to any object. The measurement is calculated according to the closest point between the object selected and the other objects involved in the measurement.
- **Freepoint** - You can freely capture measurements from any points you select. To use FreePoint measurement, deselect all the Object Snaps options, including the Vertex option which is selected by default.

4 Selection Distance - The total value of the measurement is shown, along with the X, Y, Z deltas when applicable.

5 Measurements - There are two root level groups in the Measurement tree. The Temp group captures all measurements as they are created. The other group shows the Project name, so you can create additional groups and organize project measurements.

6 Selection Details - All the details related to the selected measurement are shown. You can copy and paste in the free-form text section.

9.2 APPLY AND MANAGE MEASUREMENTS

Enter the Measurement Mode to start measuring the model.

9.2 STEP BY STEP 1 – ENTER MEASUREMENT MODE

1. Select the **Ruler** icon in the notification tray to toggle the Measure Mode on and off.
 - Alternatively, press the **M** key on the keyboard to toggle the Measure Mode

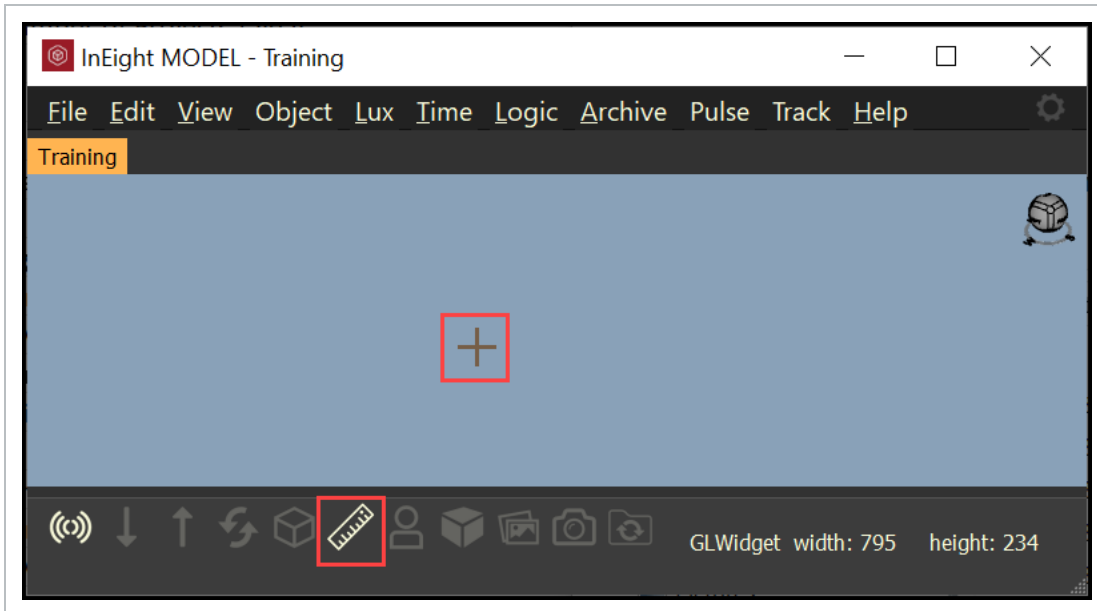
**NOTE**

While in Measure Mode the cursor will become a cross hair and the Ruler icon will appear white.

TIP

Right-click on the Ruler icon to Start/Stop Measurement or to open the Measurement panel.

9.2 STEP BY STEP 2 – TAKE A MEASUREMENT

1. Enter Measure Mode.
2. Select the first point (it will be labeled “A”).
3. Select the second point (it will be labeled “B”).

NOTE

This lettering series will continue in order for measurement types consisting of more than two points.

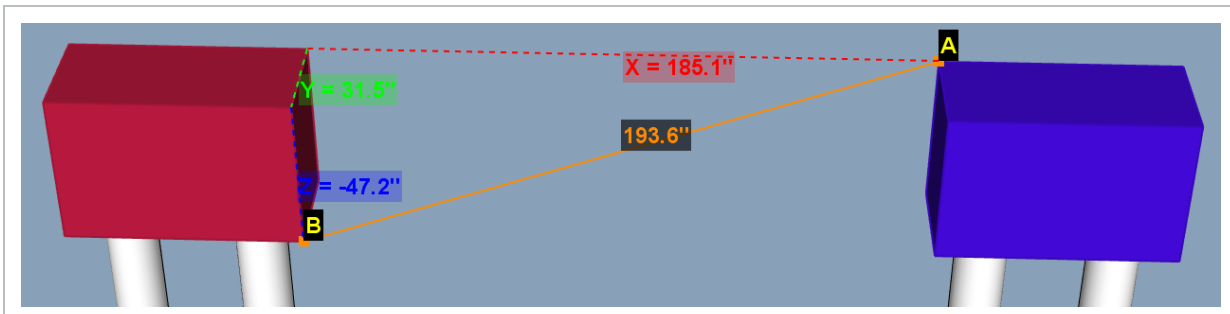

- The first object in the measurement will be highlighted blue
- The second object in the measurement will be highlighted in red
- The total distance between the selected points will be displayed in orange along the orange measurement line, which represents the closest distance between those points
- Additionally, the X, Y, Z details of each axis will be drawn as dotted lines with their respective values displayed along the path of the dotted line. The X, Y, Z axes will be colored red, green, and blue respectively

TIP

While Measure Mode is active, hold control to restore navigation to move without having to exit Measure Mode.

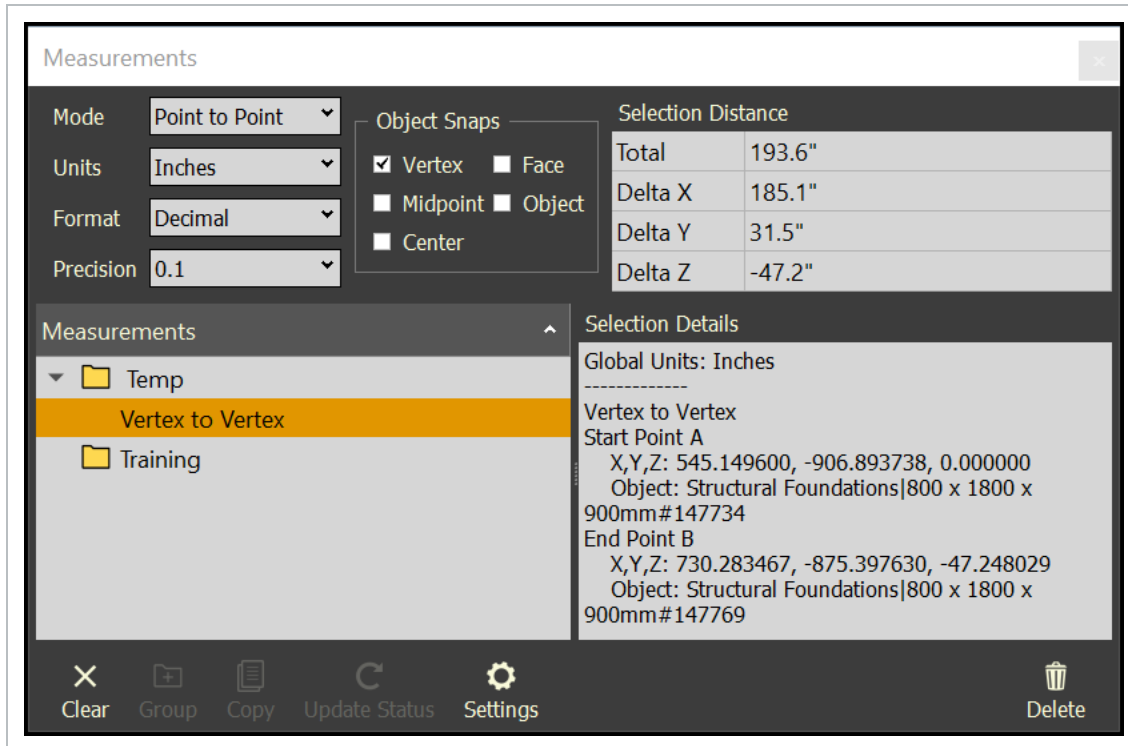

- The first object in the measurement will be highlighted blue
- The second object in the measurement will be highlighted in red
- The total distance between the selected points will be displayed in orange along the orange measurement line, which represents the closest distance between those points
- Additionally, the X, Y, Z details of each axis will be drawn as dotted lines with their respective values displayed along the path of the dotted line. The X, Y, Z axes will be colored red, green, and blue respectively

TIP

While Measure Mode is active, hold control to restore navigation to move without having to exit Measure Mode.

The screenshot displays the 'Measurements' tool interface. At the top, the title bar reads 'Measurements'. The main area is divided into several sections:

- Mode:** Point to Point (dropdown)
- Units:** Inches (dropdown)
- Format:** Decimal (dropdown)
- Precision:** 0.1 (dropdown)
- Object Snaps:** A panel with checkboxes for Vertex (checked), Face, Midpoint, Object, and Center.
- Selection Distance:** A table showing:

Total	193.6"
Delta X	185.1"
Delta Y	31.5"
Delta Z	-47.2"
- Measurements List:** A tree view showing folders 'Temp' and 'Training', with a 'Vertex to Vertex' measurement highlighted in orange.
- Selection Details:** A panel showing:
 - Global Units: Inches
 - Vertex to Vertex
 - Start Point A: X,Y,Z: 545.149600, -906.893738, 0.000000
 - Object: Structural Foundations|800 x 1800 x 900mm#147734
 - End Point B: X,Y,Z: 730.283467, -875.397630, -47.248029
 - Object: Structural Foundations|800 x 1800 x 900mm#147769

At the bottom, there is a toolbar with icons for Clear, Group, Copy, Update Status, Settings, and Delete.

9.2 STEP BY STEP 3 – DELETE A MEASUREMENT

1. Select a Measurement, then click the **Delete** icon.

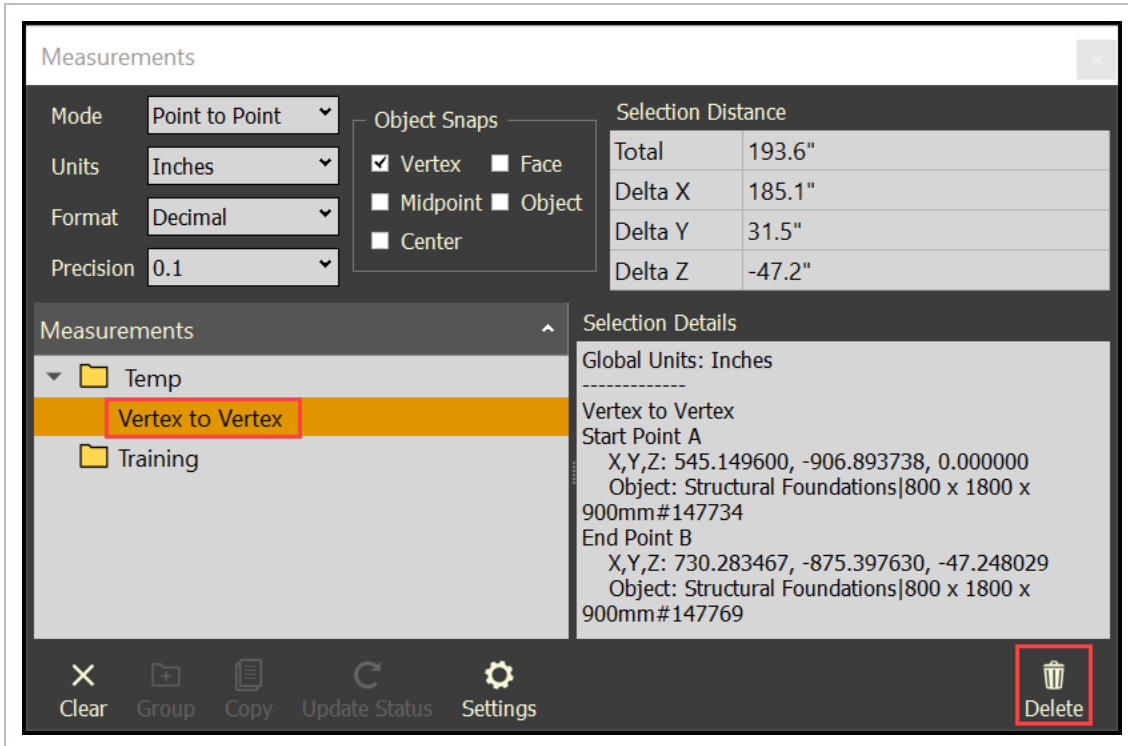

TIP Another option is to right-click on the measurement, then select **Delete**.

9.2 STEP BY STEP 4 – CLEAR MEASUREMENTS

Clear allows the user to clear any measurements selected, which also clears the 3D view of displaying measurements.

1. As one or more measurements selected, click the **Clear** icon.

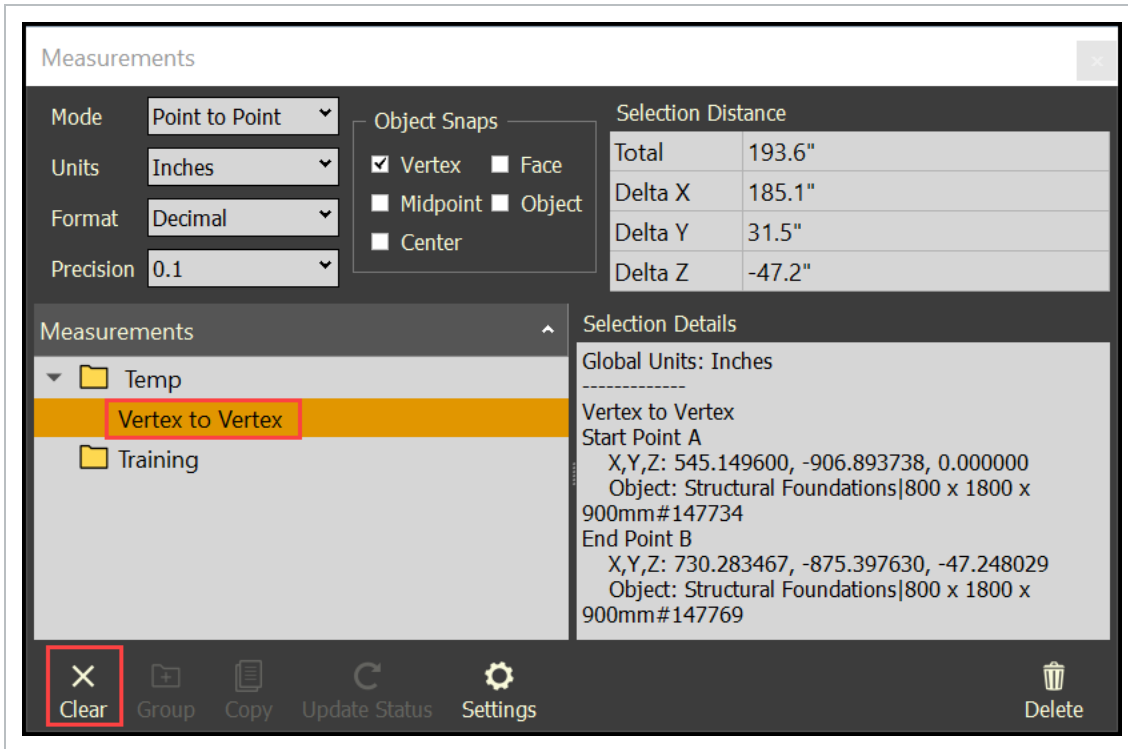

9.2 STEP BY STEP 5 – ORGANIZE MEASUREMENTS

Create groups under the project named folder to move measurements into.

1. Select your project named folder.
2. Select the **Group** icon.

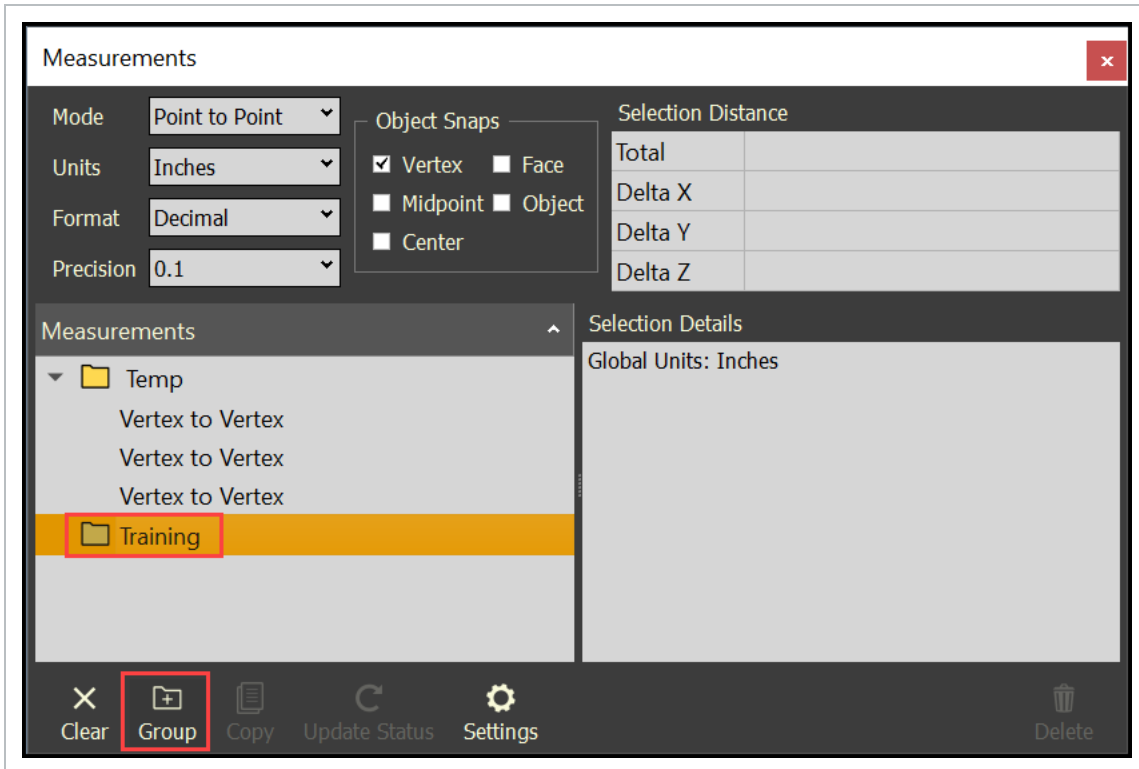

TIP Another option is to right-click on the folder, then select **New Group**.

- The New Folder dialog box will open
3. Enter a folder name, then click **OK**.

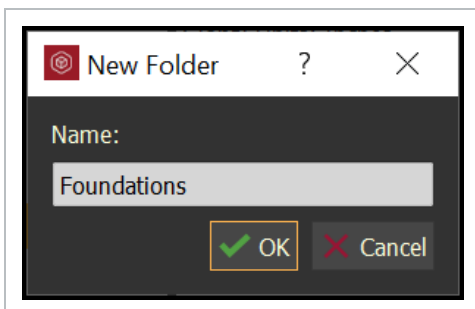

4. Drag and drop measurements into a folder.

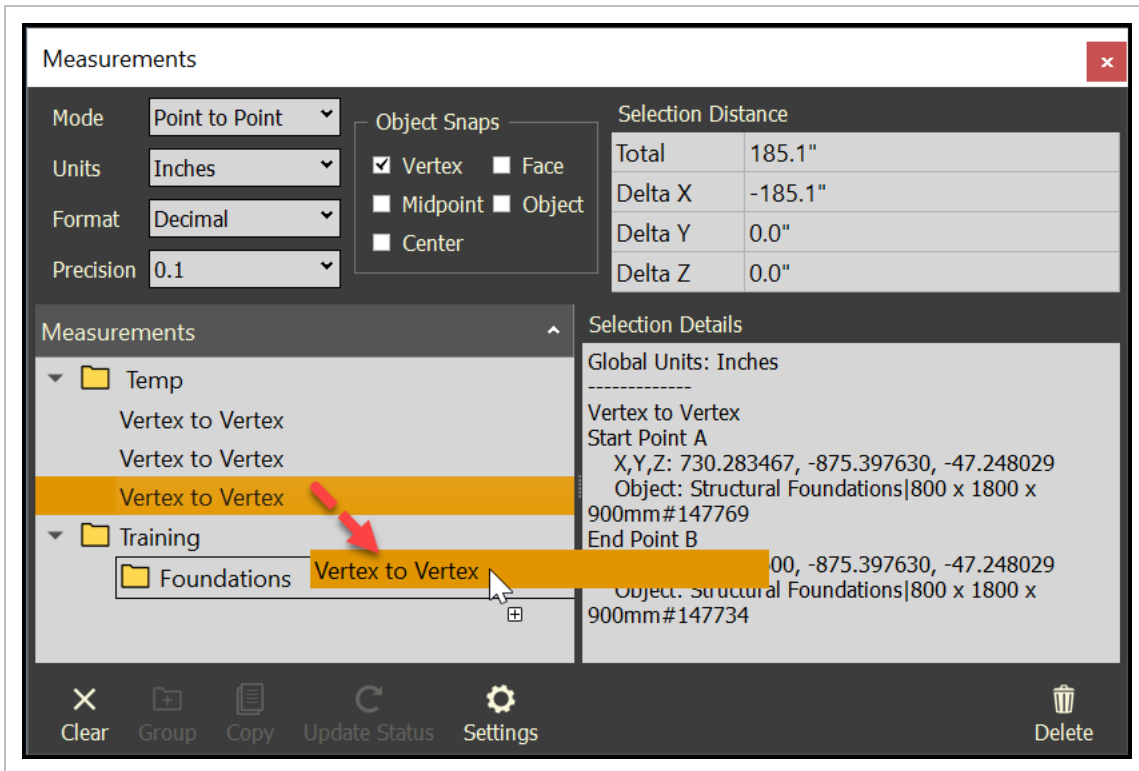

5. Right click on the measurement to rename it and better identify the measurement.

The screenshot displays the 'Measurements' tool interface. At the top, there are settings for Mode (Point to Point), Units (Inches), Format (Decimal), and Precision (0.1). An 'Object Snaps' section includes checkboxes for Vertex (checked), Face, Midpoint, Object, and Center. A 'Selection Distance' table shows Total (185.1"), Delta X (-185.1"), Delta Y (0.0"), and Delta Z (0.0").

The main area is divided into a list of measurements and a 'Selection Details' panel. The list shows a hierarchy: Temp (Vertex to Vertex), Training (Foundations (Vertex to Vertex)). The 'Vertex to Vertex' measurement under 'Foundations' is selected and highlighted in orange. A context menu is open over this measurement, with 'Rename' highlighted in a red box. Other menu items include 'Copy Spot ID selection to clipboard', 'New Group', 'Delete', and 'Update Status'.

The 'Selection Details' panel shows: Global Units: Inches, Vertex to Vertex, Start Point A, X,Y,Z: 730.283467, -875.397630, -47.248029, and Object: Structural Foundations|800 x 1800 x 900mm#147769.

At the bottom, there are icons for Clear, Group, Copy, Update, and Delete.

LESSON 9 REVIEW

1. Which of the following is NOT an option on the Measurements panel?
 - a. Master presets
 - b. Object Snaps
 - c. Selection Distance
 - d. Selection Details

2. You cannot save measurements in InEight Model.
 - a. True
 - b. False

3. To begin working with measurements, you must first enter Measurement Mode.
 - a. True
 - b. False

LESSON 9 SUMMARY

As a result of this lesson, you can:

- Navigate the Measurement panel and enter Measuring Mode
- Take and delete measurements
- Organize and clear measurements

CHAPTER 10 – MODEL EXPORTS

10.1 IFC EXPORT

With IFC Export, you can select model objects and then export selected graphics and related TAG data into an IFC file format. This provides the ability to export collaborative updates to project teams members.

IFC 2x3 is the supported file type in Model. IFC files are an open international standard for Building Information Modeling (BIM) data that are exchanged and shared among software applications used by the various participants in the construction or facility management industry sector.

10.1 STEP BY STEP 1 – IFC EXPORT

1. To access IFC Export, select **File** from the menu bar at the top of the screen.
2. Select **Export Selected to IFC....** The Windows Explorer opens.

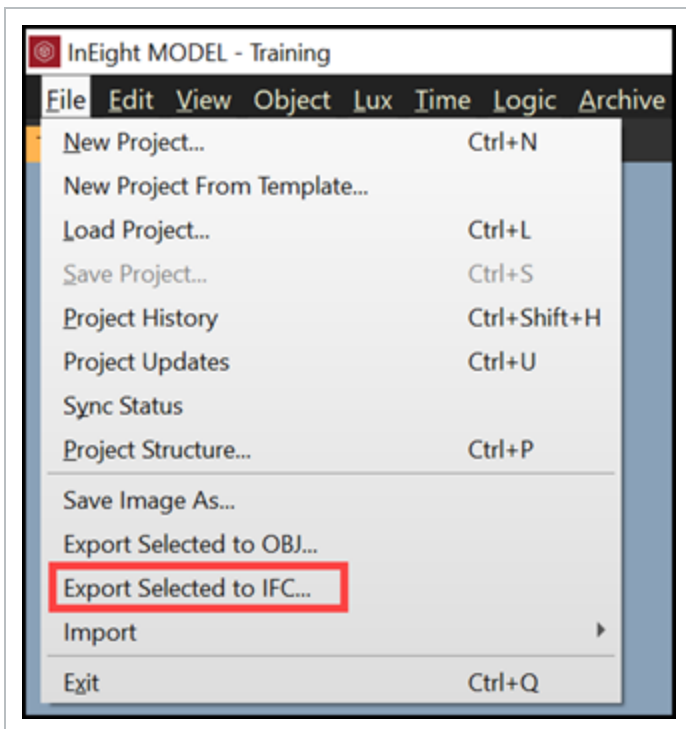

3. Browse to the desired location to store the .ifc file.

4. Name the .ifc file with a relevant name , and then click **Save**.

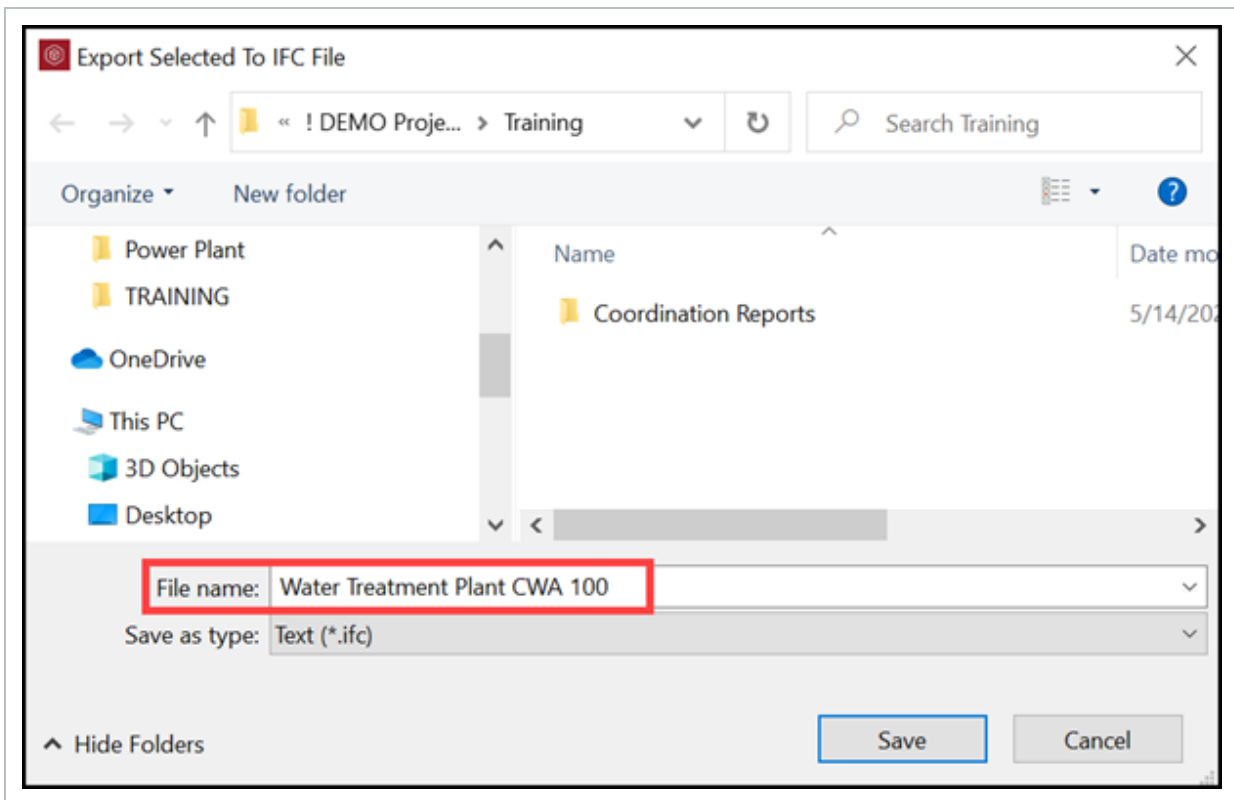

10.2 OBJ EXPORT

With the OBJ Export, you can select model objects, and then export selected graphics and related TAG data into an OBJ file format.

10.2 STEP BY STEP 1 – OBJ EXPORT

1. To access OBJ Export, select File from the menu bar at the top of the screen.
2. Select **Export Selected to OBJ...** Windows Explorer opens.

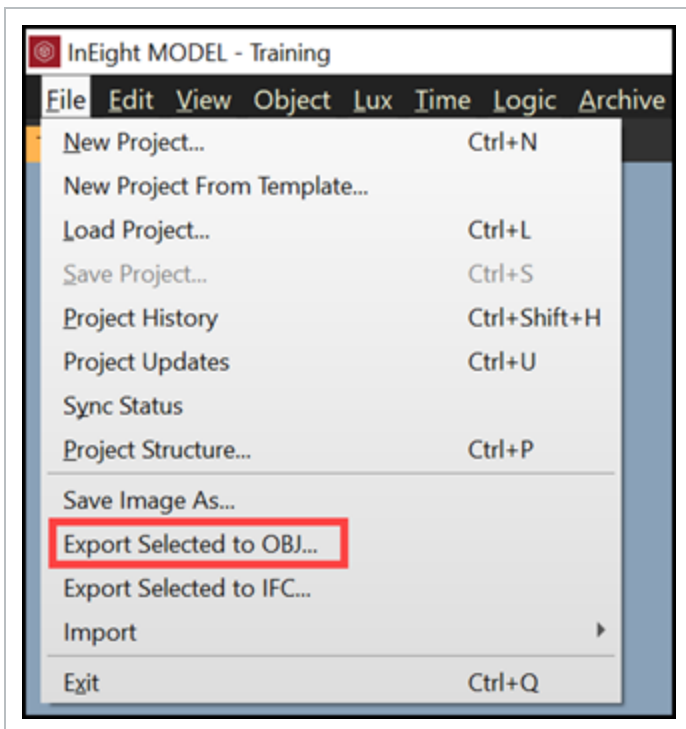

3. Browse to the desired location to store the .obj file.
4. Name the .obj file with a relevant name, and then click **Save**.

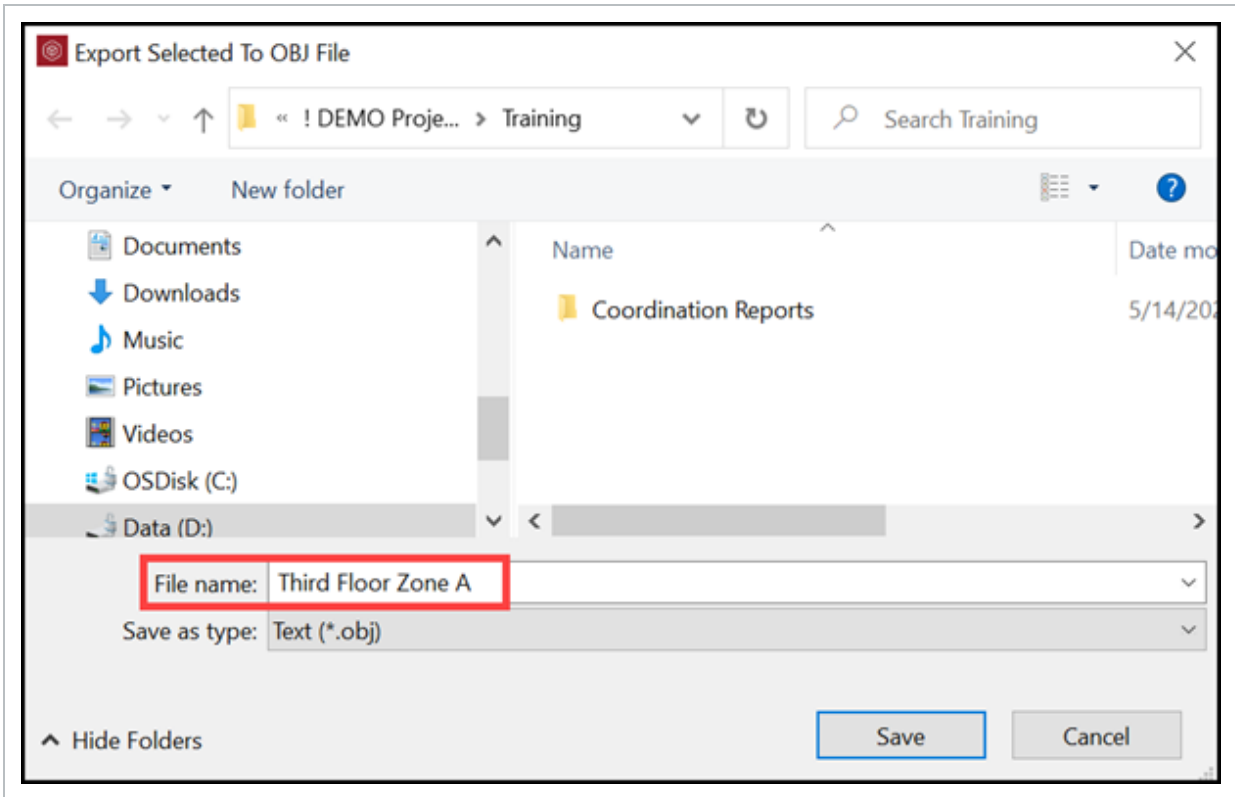

This page intentionally left blank.

CHAPTER 11 – MODEL-BASED TAKEOFF

11.1 MODEL-ESTIMATE OVERVIEW

There are two methods for using Model quantities and integrating them with InEight Estimate, either the Model and Estimate integration, or the quantity function in DTOs that integrate with the Microsoft Excel Plug-in. For more information about DTO quantity integration with Excel Plug-in, see **Access quantities via Excel Plug-in** in [Quantify model data](#).

The following table shows Model integration for Estimate on-premise and SaaS.

Cost item information - Estimate to Model	On-premise	SaaS
CBS number	✓	✓
Description	✓	✓
Unit of Measure	✓	✓
User defined field 11	X	✓
User defined field 12	✓	✓
User defined field 13	✓	✓
User defined field 14	✓	✓
User defined field 15	✓	✓

Cost item information - Estimate to Model	On-premise	SaaS
Parent level UDF 11	X	✓
Parent level UDF 12	X	✓
Parent level UDF 13	X	✓
Parent level UDF 14	X	✓
Parent level UDF 15	X	✓

11.2 MODEL AND ESTIMATE INTEGRATION USING THE MODEL CONNECTOR

You can use Model to sum object quantities and sync them to Estimate using the Model Connector functions. In Estimate, there are functions in the main ribbon of the CBS in the More Actions > **Model Connector** section that integrate with Model.

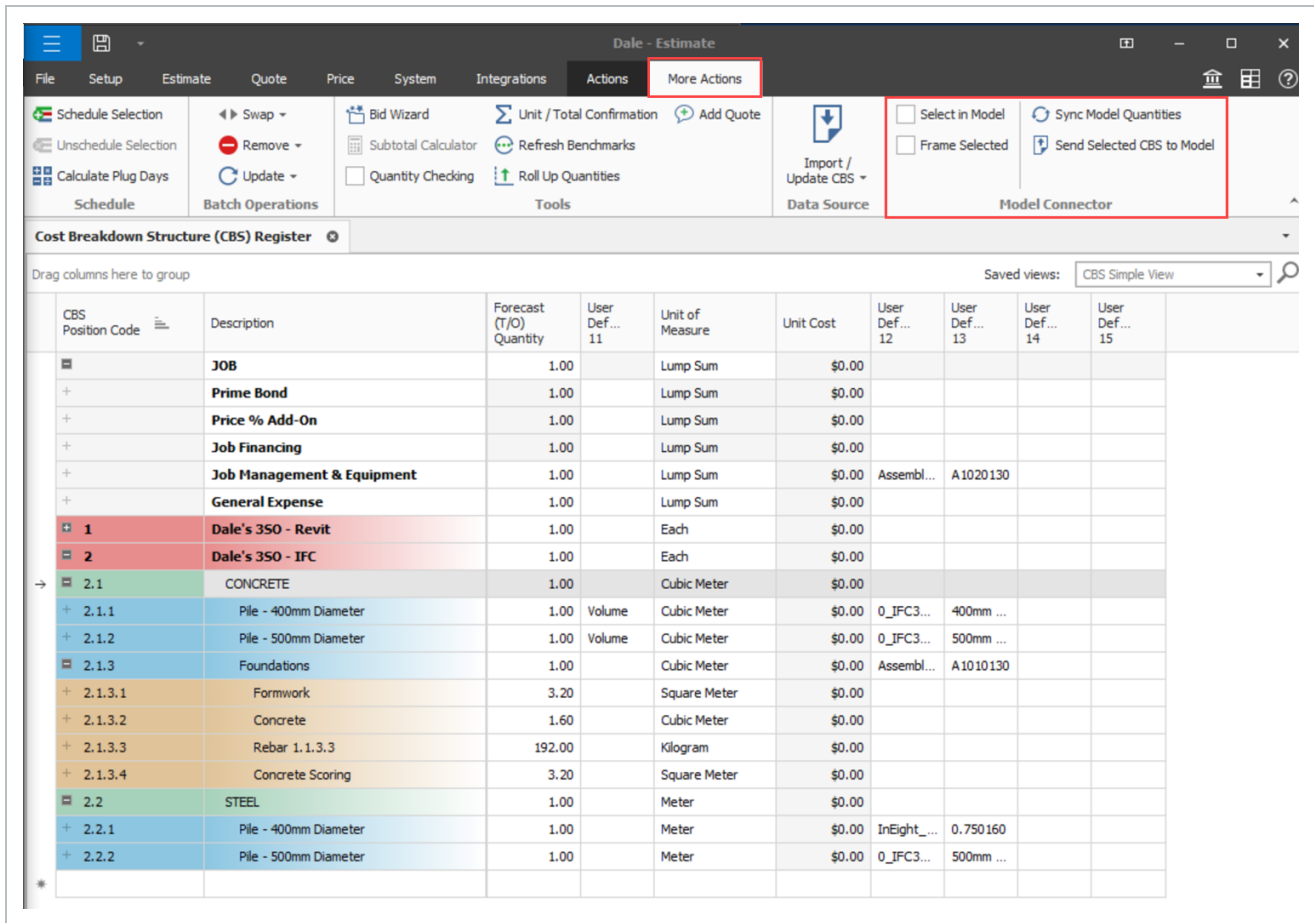

The Model Connector functions are described in the following table:

Function	Description
Select in Model	When you select a cost item, the linked Model objects are selected in Model.
Frame selected	When you select a cost item, the linked Model objects are framed in the Model viewer.
Sync Model Quantities	After you execute a DTO to sum quantities in Model, you can then sync Model quantities into Estimate.
Send Selected CBS to Model	When you select a child item in the CBS structure, then the parent hierarchy with that selected child will be pushed to Model. When you push a parent CBS item, then the parent and all children are pushed to Model.

When you send CBS cost items to Model, the CBS structure of the selected cost item or parent cost item is sent to the DTO panel. On the DTO tab, the CBS hierarchy is converted into DTO Groups and DTOs. All parent levels of the hierarchal tree create DTO Groups with the children level of the tree creating DTOs .

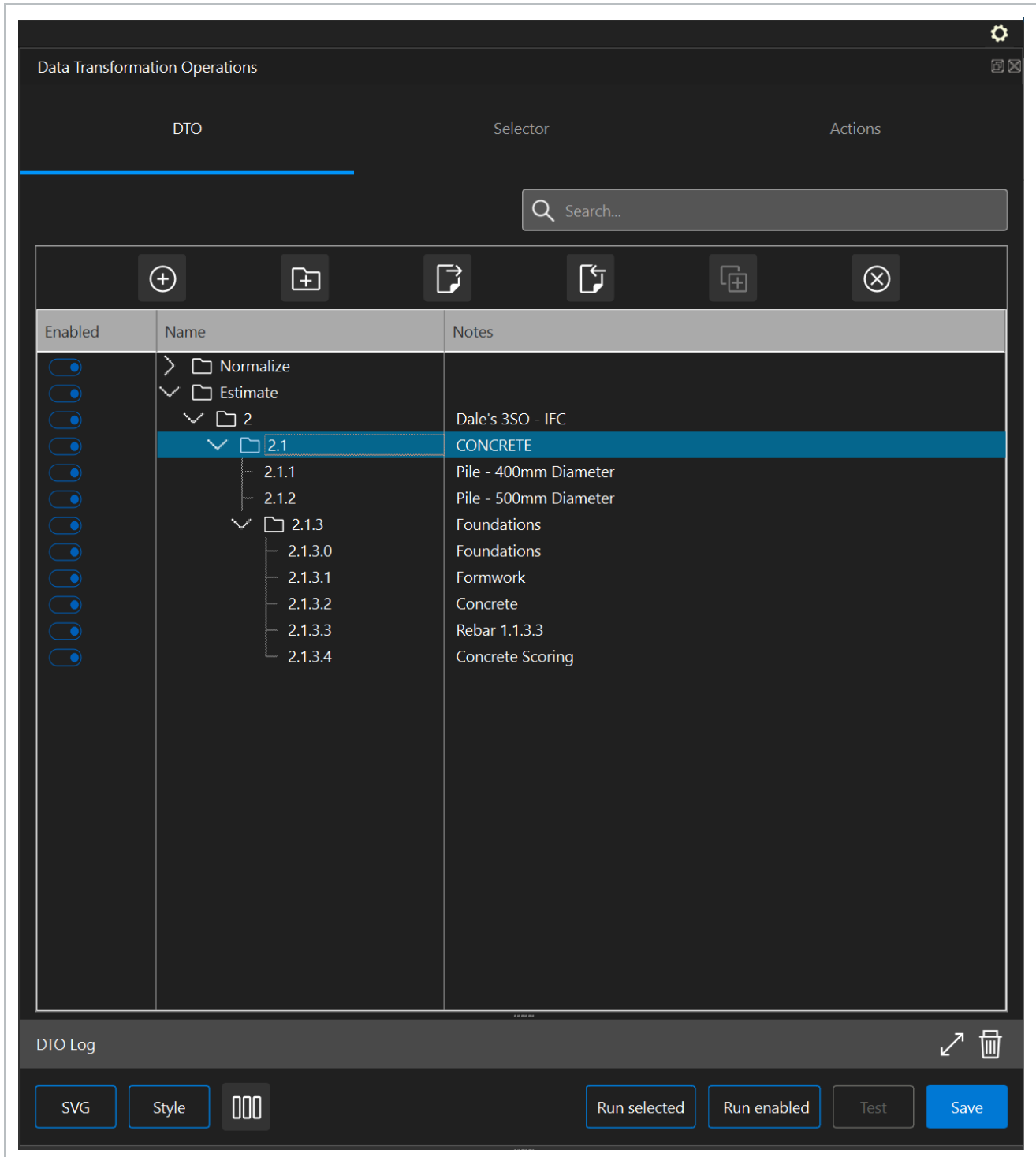

User-defined fields 11-15 are used to sync data to Model’s Selector and Action tabs in the DTO panel. For more information, see [User-Defined Fields](#). For more information about Model integration with Estimate, see [Model-Estimate overview](#).

11.2.0.1 SUMMING QUANTITIES USING A PARENT COST ITEM

When a parent cost item is sent from Estimate to Model, the parent cost item becomes a DTO group in Model. To estimate at a parent level, you must enter the Tag Name and Value information in User Defined 12 and 13 fields in Estimate, and then send the parent cost item to Model.

Drag columns here to group		Saved views: CBS Simple View								
CBS Position Code	Description	Forecast (T/O) Quantity	User Def... 11	Unit of Measure	Unit Cost	User Defined 12	User Defined 13	User Def... 14	User Def... 15	
+	JOB	1.00		Lump Sum	\$0.00					
+	Prime Bond	1.00		Lump Sum	\$0.00					
+	Price % Add-On	1.00		Lump Sum	\$0.00					
+	Job Financing	1.00		Lump Sum	\$0.00					
+	Job Management & Equipment	1.00		Lump Sum	\$0.00					
+	General Expense	1.00		Lump Sum	\$0.00					
1	Dale's JSO - Revit	1.00		Each	\$0.00					
2	Dale's JSO - IFC	1.00		Each	\$0.00					
2.1	CONCRETE	1.00		Cubic Meter	\$0.00					
+ 2.1.1	Pile - 400mm Diameter	1.00	Volume	Cubic Meter	\$0.00	Estimating Tags	400mm Diameter			
+ 2.1.2	Pile - 500mm Diameter	1.00	Volume	Cubic Meter	\$0.00	Estimating Tags	500mm Diameter			
2.1.3	Foundations	1.00		Cubic Meter	\$0.00	Estimating Tags	400mm Diameter			
+ 2.1.3.1	Formwork	3.20		Square Meter	\$0.00					
+ 2.1.3.2	Concrete	1.60		Cubic Meter	\$0.00					
+ 2.1.3.3	Rebar 1.1.3.3	192.00		Kilogram	\$0.00					
+ 2.1.3.4	Concrete Scoring	3.20		Square Meter	\$0.00					

In the DTO panel, the DTO tab shows the tree structure with the parent cost item as a DTO group and as a DTO , and child cost items as DTOs.

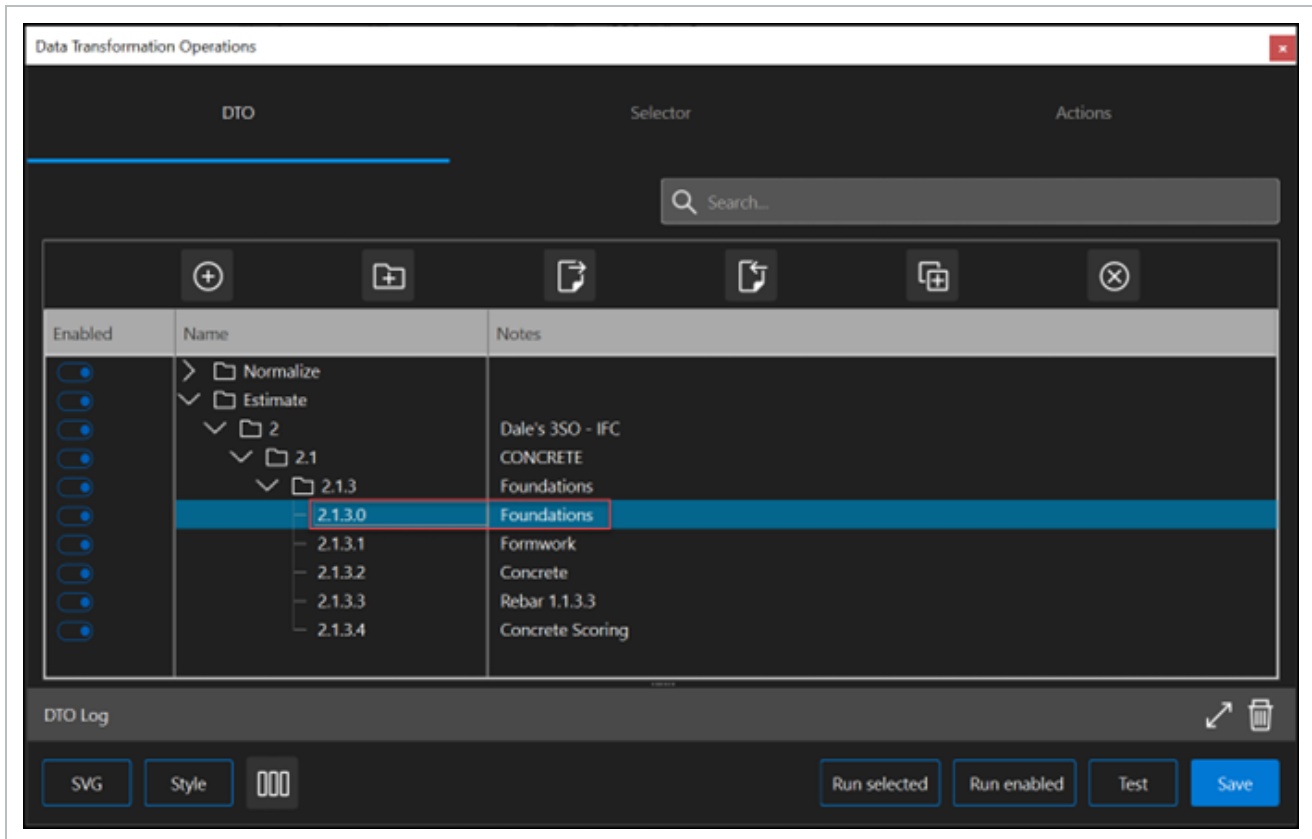

11.2.1 CONSIDERATIONS

- Estimate version 2023.0 or later must be installed.
- The Estimate add-in for Model Client Plug-ins must be installed.
- InEight Model must be installed.
- One instance of InEight Model and one instance of InEight Estimate must be open on the same computer.

11.2.2 STEPS

SEND SELECTED CBS STRUCTURE TO MODEL'S DTO PANEL

1. Open one instance of Model and one instance of Estimate.
2. In Estimate, create or open a project, and then open the CBS register.
3. In Model, select **Load a Project**, and then open the DTO panel.

4. In Estimate, select a cost item or a parent cost item.
5. In the top ribbon, select **More Actions** , and then select **Send Selected CBS to Model** in the Model Connector section.
6. When the Estimate CBS items are sent successfully, a Success dialog box shows. Click **OK** in the Success dialog box to close it.

RUN MODEL DTOS

1. In the DTO panel, select a DTO created from the CBS items sent from Estimate. You will see that a rule is automatically created in the Selector tab based on the input from the user-defined fields in Estimate. For more information about creating rule types manually, see [Manage DTOs](#).

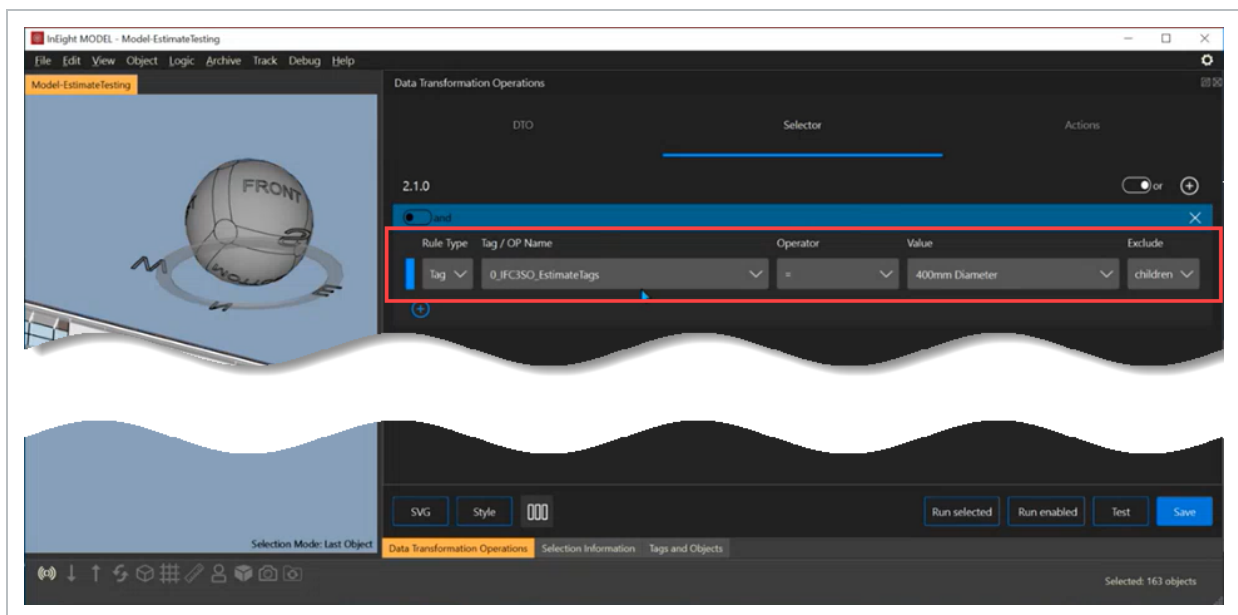

2. Click **Test** to validate and review all the information for model objects in the Selection Information Panel.
3. In the Actions tab, validate that the Quantity Type fields are set to the necessary summation of the quantities.

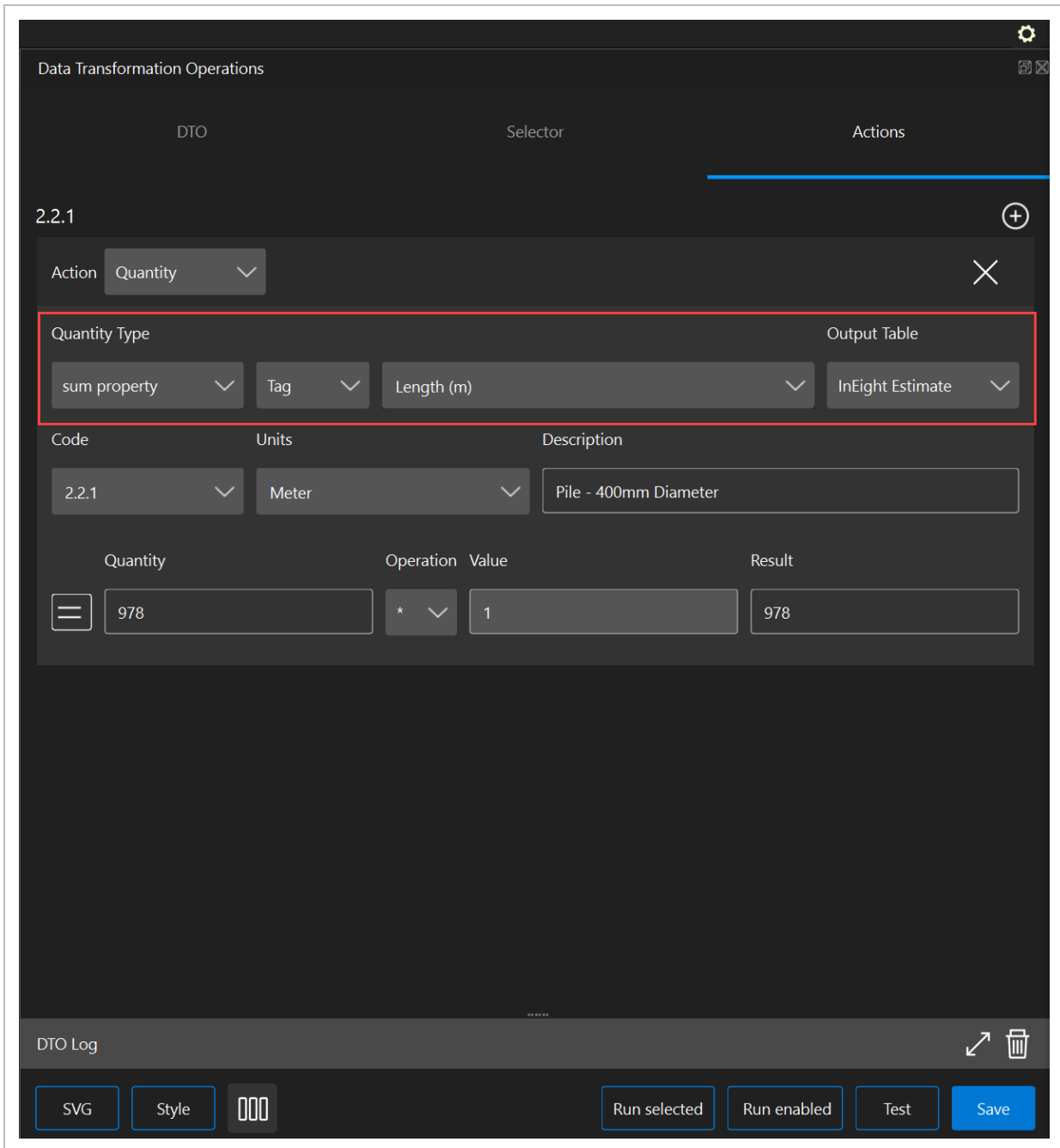

4. Repeat steps 1-3 for the other DTOs.
5. Run the individual DTOs or you can select higher in the hierarchy to run parent and child DTOs.

SYNC MODEL QUANTITIES

1. After selecting to run DTOs, in Estimate, select **Sync Model Quantities** in the More Actions > **Model Connector** section in the top ribbon. The Sync Model Quantities dialog box opens and, in the Model, QTY column it shows the quantities in Model. The Current QTY column shows the Forecast (T/O) Quantity in Estimate.

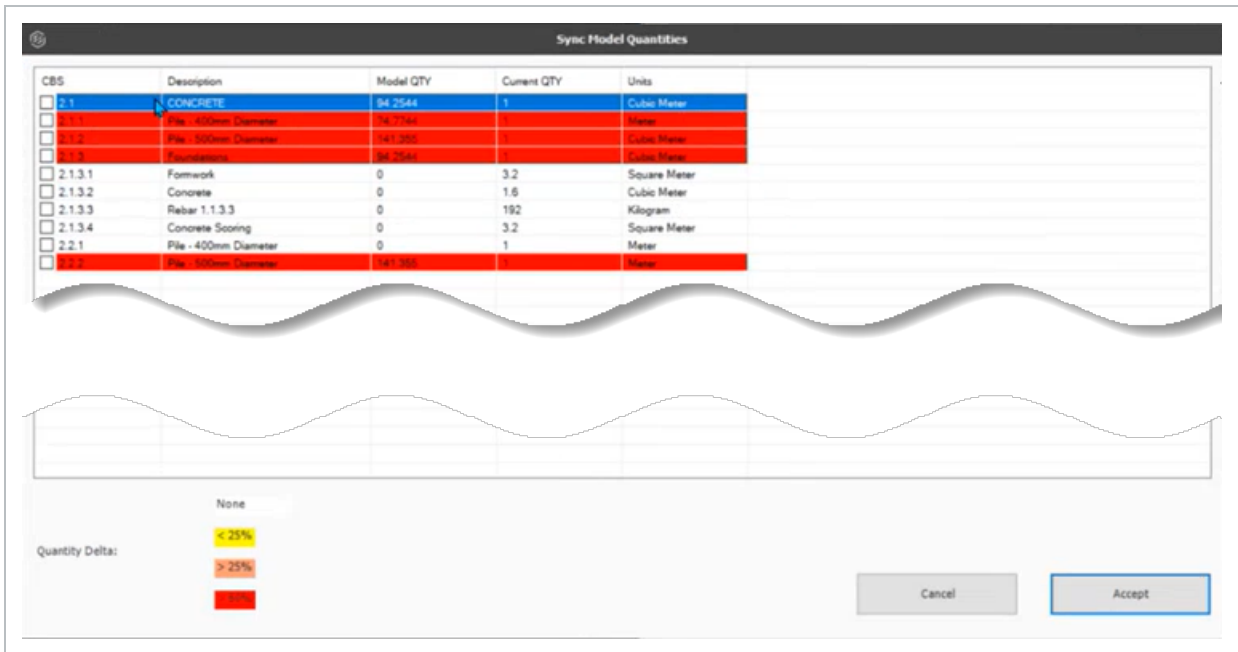

2. Select all cost items, and then click **Accept**. The quantities derived from the model are now in Estimate.

SELECT AND FRAME MODEL OBJECTS

1. In Estimate > More Actions > **Model Connector**, select the check boxes for **Select in Model** and **Frame Selected**.

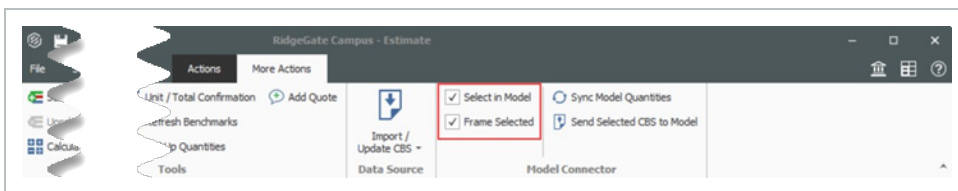

2. Select a cost item in Estimate, and then in Model you can view which model objects were used to create the quantities.

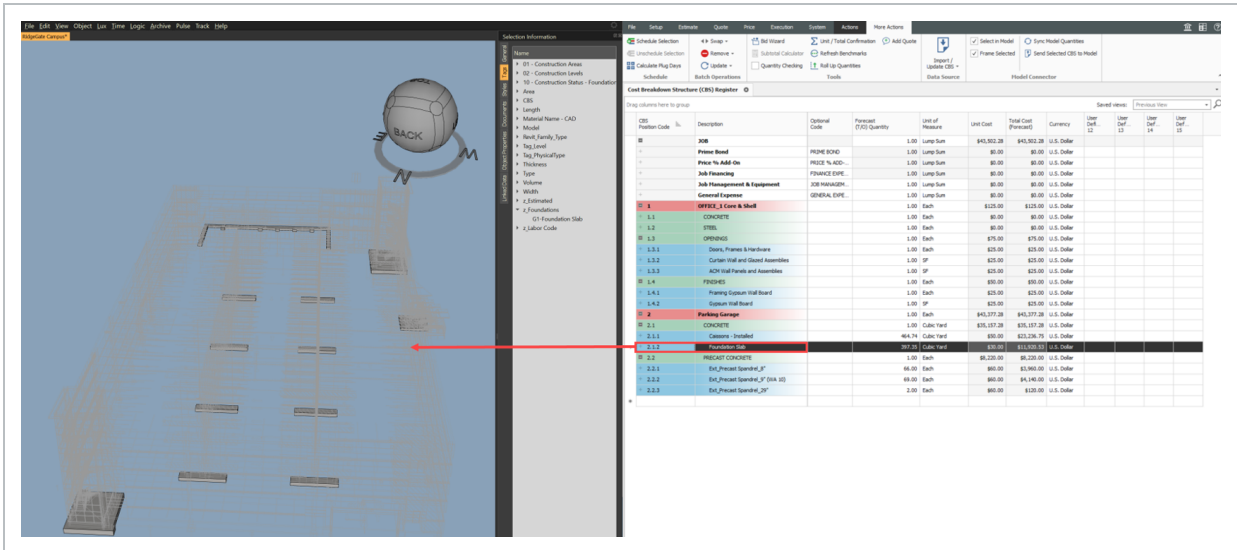
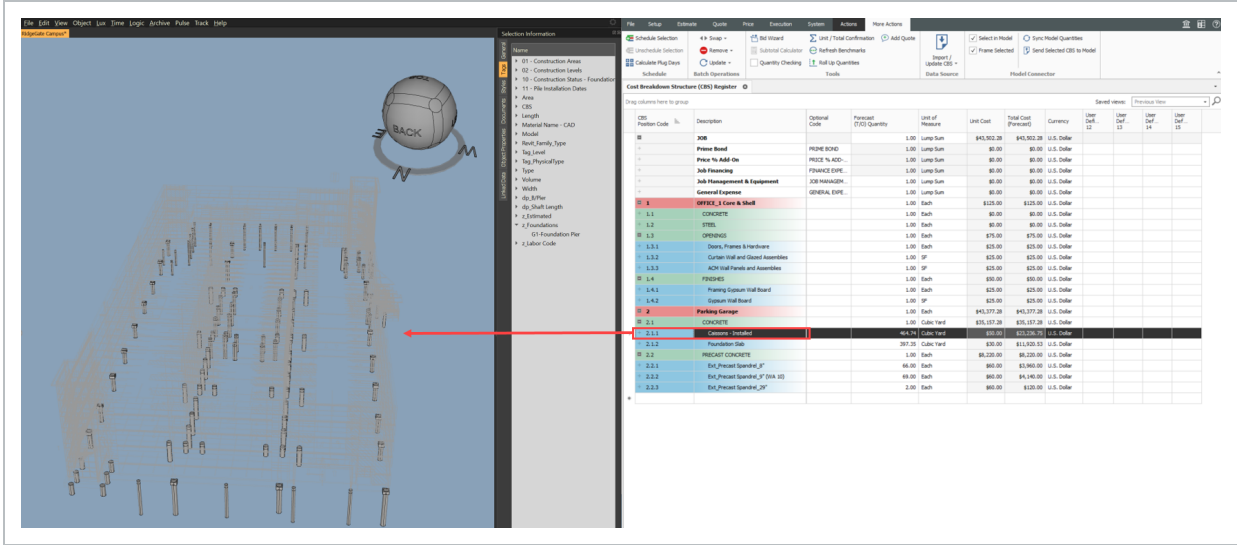

11.3 USER-DEFINED FIELDS

When you use the Model Connector functions, user-defined fields (UDF)11-15 sync their data from Estimate to the DTO panel in Model .

The following table shows the UDF integration to Model:

UDF	Description
User Defined	Actions tab - Populates the Tag Name in the Quantity Type sum property.

UDF	Description
11	
User Defined 12	Selection tab - Populates the Tag / OP Name field in the first rule.
User Defined 13	Selection tab - Populates the Value field of UDF 12 Tag/OP Name in the first rule.
User Defined 14	Selection tab - Populates the Tag / OP Name field in the second rule.
User Defined 15	Selection tab - Populates the Value field of UDF 14 Tag / OP Name in the second rule.

NOTE UDF 11 does not integrate with Estimate on-premise.

DTOs use the Selector tab to create criteria for selecting model objects. The Actions tab creates the summation of the quantities to share with Estimate.

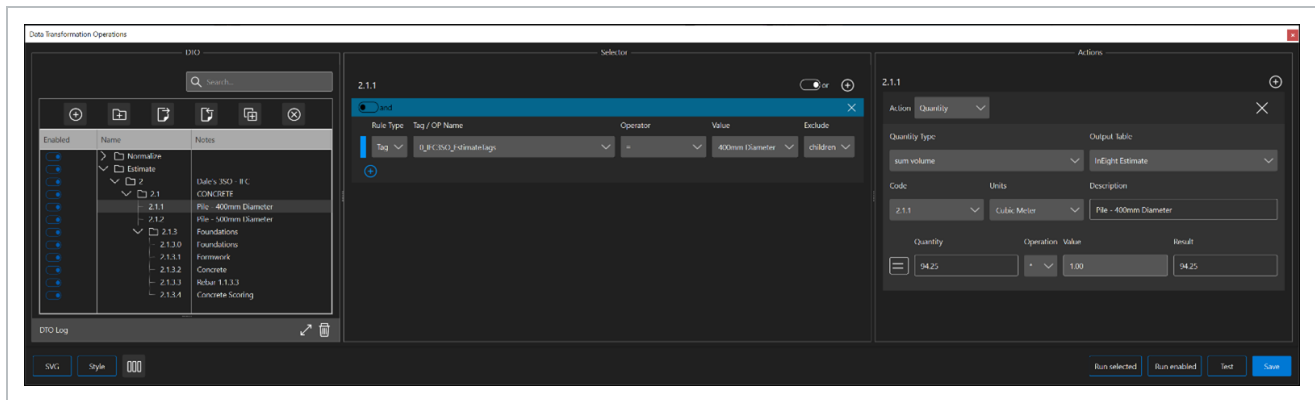

When UDF 12 and UDF 13 are populated and UDF 14 and UDF 15 are not populated, then only one rule is created in the DTO Selector area. If all four UDFs are populated, then two rules are created, and the modifier is set to AND. The first rule is populated from UDF 12 and 13. The second rule is populated from UDF 14 and 15.

NOTE The Tag / OP Name field must exist in the model or it will be blank. The Operator is set to = by default. The Value must exist in the model, or it will be blank.

11.3.1 STEPS

The following are examples of UDFs integration with Model. We use cost item 2.1.1 for the examples.

RULE SETUP USING USER DEFINED 12 AND 13 FIELDS

1. In Model, select a model object that represents the cost item. We will use cost item 2.1.1 - Pile 400mm Diameter to identify a tag name and value to use for UDF 12 and 13.
2. In Estimate, enter the following UDF information for cost item 2.1.1:

UDF	Description
UDF 12	Estimating Tags
UDF 13	400mm Diameter

CBS Position Code	Description	Forecast (T/C) Quantity	User Def... 11	Unit of Measure	Unit Cost	User Defined 12	User Defined 13	User Def... 14	User Def... 15
JOB		1.00		Lump Sum	\$0.00				
+	Prime Bond	1.00		Lump Sum	\$0.00				
+	Price % Add-On	1.00		Lump Sum	\$0.00				
+	Job Financing	1.00		Lump Sum	\$0.00				
+	Job Management & Equipment	1.00		Lump Sum	\$0.00				
+	General Expense	1.00		Lump Sum	\$0.00				
1	Dale's 350 - Revit	1.00		Each	\$0.00				
2	Dale's 350 - IFC	1.00		Each	\$0.00				
2.1	CONCRETE	1.00		Cubic Meter	\$0.00				
2.1.1	Pile - 400mm Diameter	1.00		Cubic Meter	\$0.00	Estimating Tags	400mm Diameter		
2.1.2	Pile - 500mm Diameter	1.00		Cubic Meter	\$0.00	Estimating Tags	500mm Diameter		

3. In More Actions > **Model Connector**, click **Send Selected CBS to Model**.
4. In the Success dialog box, click **OK**. A rule is created in Model > DTO > **Selector** tab from the data

entered in the UDFs.

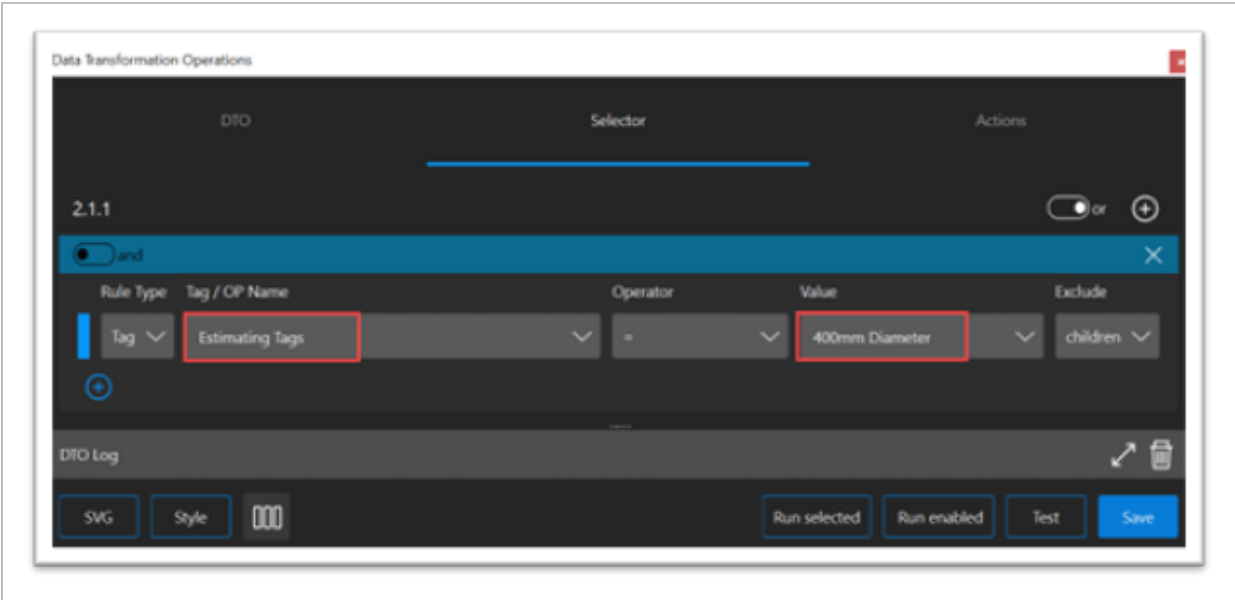

RULE SETUP USING USER DEFINED 12-15 FIELDS

1. In Estimate, enter the following information for cost item 2.1.1:

UDF	Description
UDF 12	Estimating Tags
UDF 13	400mm Diameter
UDF 14	Construction Zone
UDF 15	Area A

The screenshot shows a software interface with a table of cost items. The table has columns for CBS Position Code, Description, Forecast (T/O) Quantity, User Defi... 11, Unit of Measure, Unit Cost, and four User Defined fields (12, 13, 14, 15). The row for '2.1.1 Pile - 400mm Diameter' is highlighted in green and has values in the User Defined fields: Estimating Tags, 400mm Diameter, Construction Zone, and Area A.

CBS Position Code	Description	Forecast (T/O) Quantity	User Defi... 11	Unit of Measure	Unit Cost	User Defined 12	User Defined 13	User Defined 14	User Def... 15
	JOB	1.00		Lump Sum	\$0.00				
	Prime Bond	1.00		Lump Sum	\$0.00				
	Price % Add-On	1.00		Lump Sum	\$0.00				
	Job Financing	1.00		Lump Sum	\$0.00				
	Job Management & Equipment	1.00		Lump Sum	\$0.00				
	General Expense	1.00		Lump Sum	\$0.00				
1	Dale's 350 - Revit	1.00		Each	\$0.00				
2	Dale's 350 - IFC	1.00		Each	\$0.00				
2.1	CONCRETE	1.00		Cubic Meter	\$0.00				
2.1.1	Pile - 400mm Diameter	1.00		Cubic Meter	\$0.00	Estimating Tags	400mm Diameter	Construction Zone	Area A
2.1.2	Pile - 500mm Diameter	1.00		Cubic Meter	\$0.00	Estimating Tags	500mm Diameter		

2. Click **Send Selected CBS to Model**, and then in the Success dialog box click **OK**. Rules are created

in the Selector tab from the data entered in the UDFs.

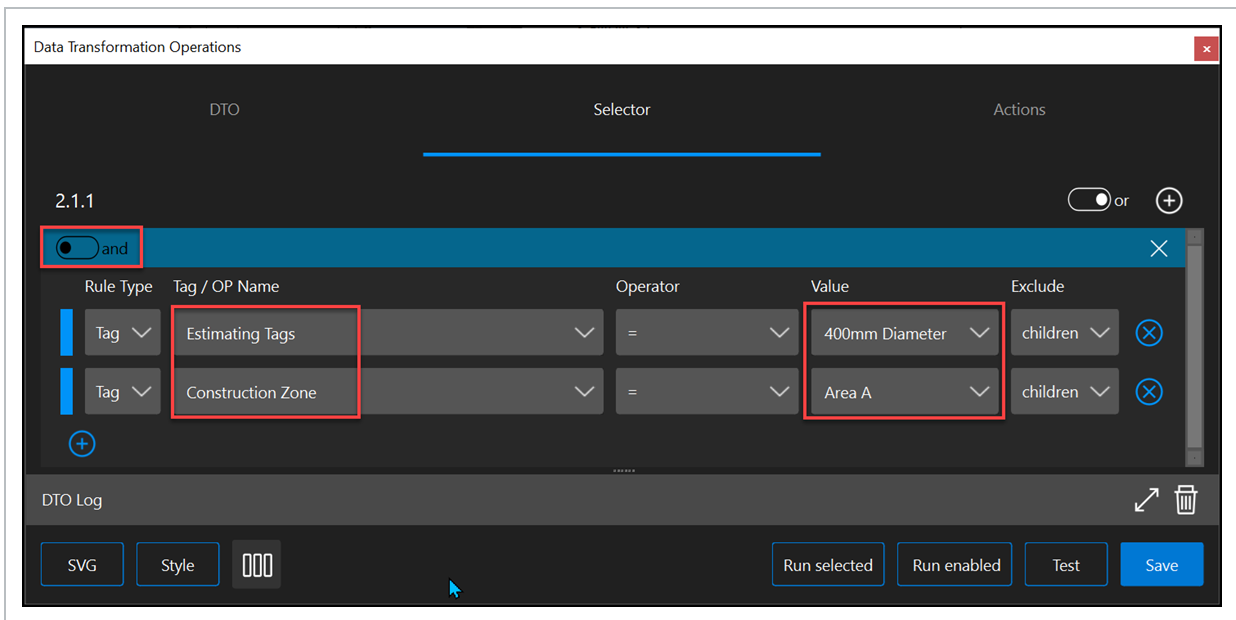

RULE SETUP USING USER DEFINED 11 FIELD

1. In Estimate, enter *Volume* for cost item 2.1.1 in UDF 11.

CBS Position Code	Description	Forecast (T/O) Quantity	User Def... 11	Unit of Measure	Unit Cost	User Defined 12	User Defined 13	User Defined 14	User Def... 15
	JOB	1.00		Lump Sum	\$0.00				
	Prime Bond	1.00		Lump Sum	\$0.00				
	Price % Add-On	1.00		Lump Sum	\$0.00				
	Job Financing	1.00		Lump Sum	\$0.00				
	Job Management & Equipment	1.00		Lump Sum	\$0.00				
	General Expense	1.00		Lump Sum	\$0.00				
1	Dale's 350 - Revit	1.00		Each	\$0.00				
2	Dale's 350 - IFC	1.00		Each	\$0.00				
2.1	CONCRETE	1.00		Cubic Meter	\$0.00				
2.1.1	Pile - 400mm Diameter	1.00	Volume	Cubic Meter	\$0.00	Estimating Tags	400mm Diameter	Construction Zone	Area A
2.1.2	Pile - 500mm Diameter	1.00		Cubic Meter	\$0.00	Estimating Tags	500mm Diameter		

2. Select **Send Selected CBS to Model**, and then in the Success dialog box click **OK**. The Quantity

Type's UoM is populated in the Action tab from the data entered in UDF 11.

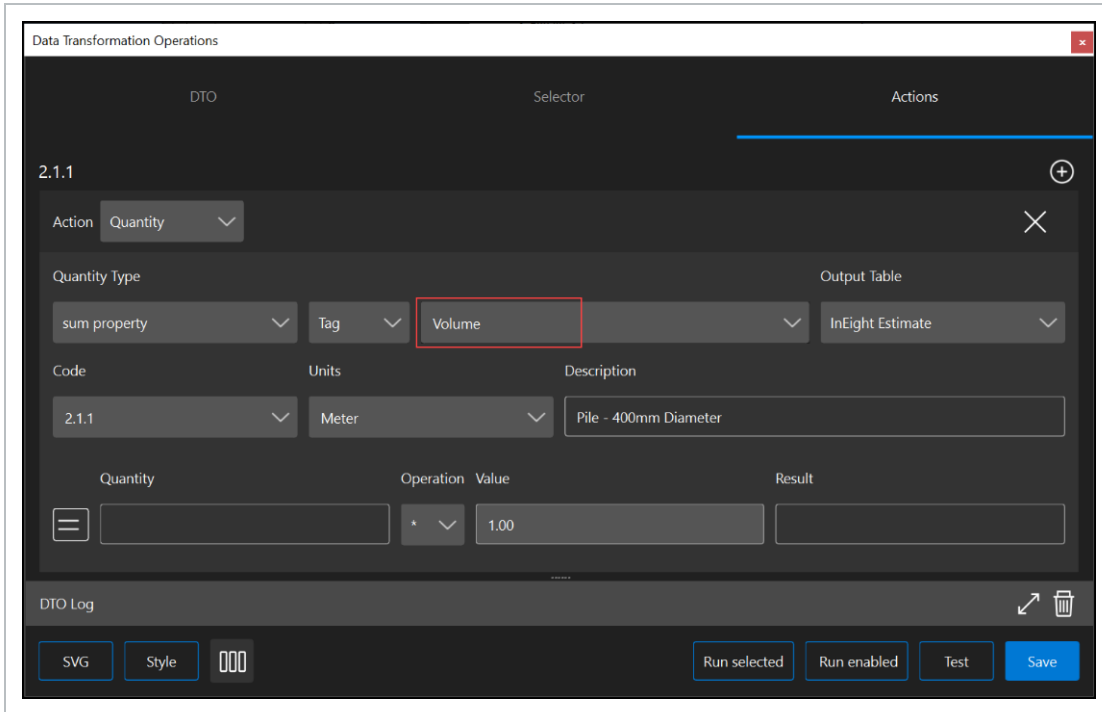

CHAPTER 12 – ELEMENTS

12.1 ELEMENTS OVERVIEW

Elements formalize relationships between components, equipment, systems, subsystems, etc. Maintaining the thread of data from Design to Construction to Quality to Closeout; customizable based on project requirements and participating in an Advanced Work Packaging process.

The new Elements panel within InEight model provides the capability to create Material Components (individual or combined model objects). The Material Components created in Model are linked to the AWP process (Model <-> Plan and Model <-> Schedule) and to the Completions applications.

Within Completions, Assets have been transitioned into Elements, which provides a direct link from Completions to Model. In a general sense, Elements created in Completions are now visible within Model and Elements created in Model are visible in Completions

Elements are more flexible than Assets in that they can have a hierarchical relationship and display different data based on Element type or classification (system, subsystem, building intersection, engineered equipment, etc.) With this transition, users can access Elements data from Completions HQ, Mobile, and Model applications.

12.1.1 ELEMENTS PANEL

To access the Elements Panel, select **View** from the menu bar at the top of the screen. Then, select **Elements**.

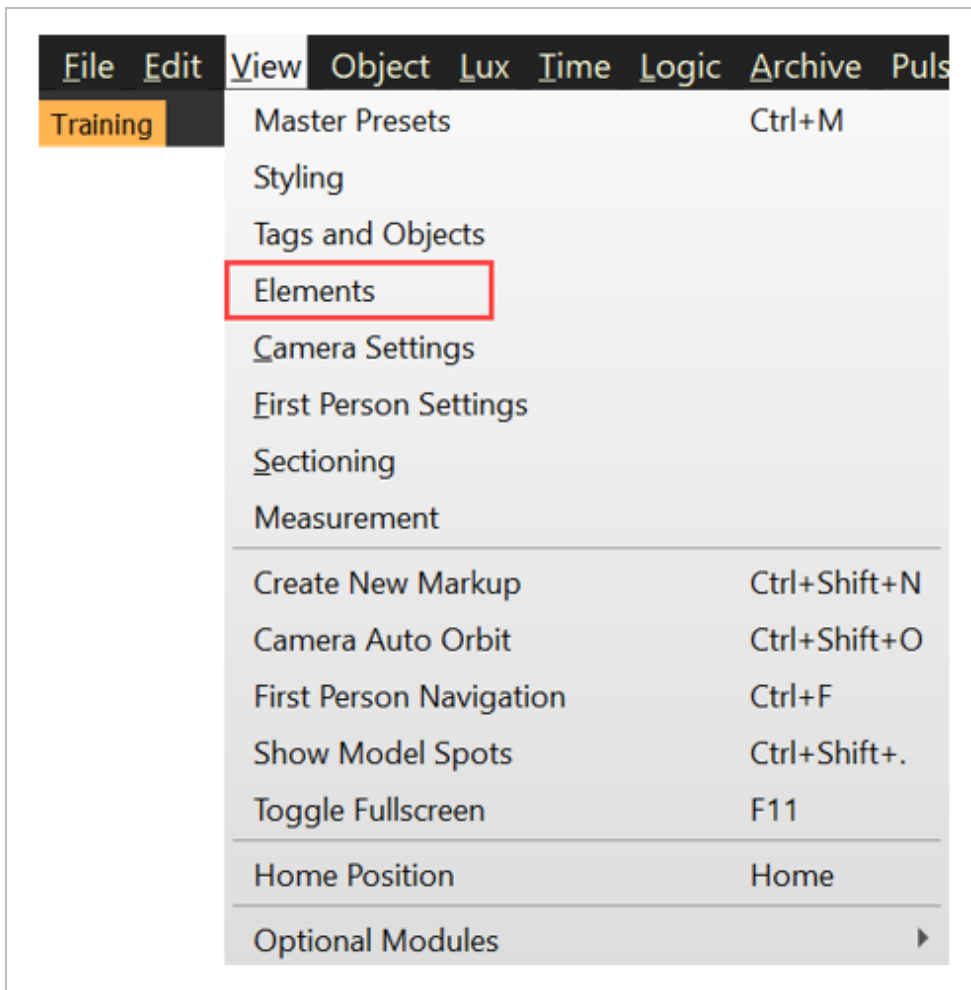

This will open the Elements Panel.

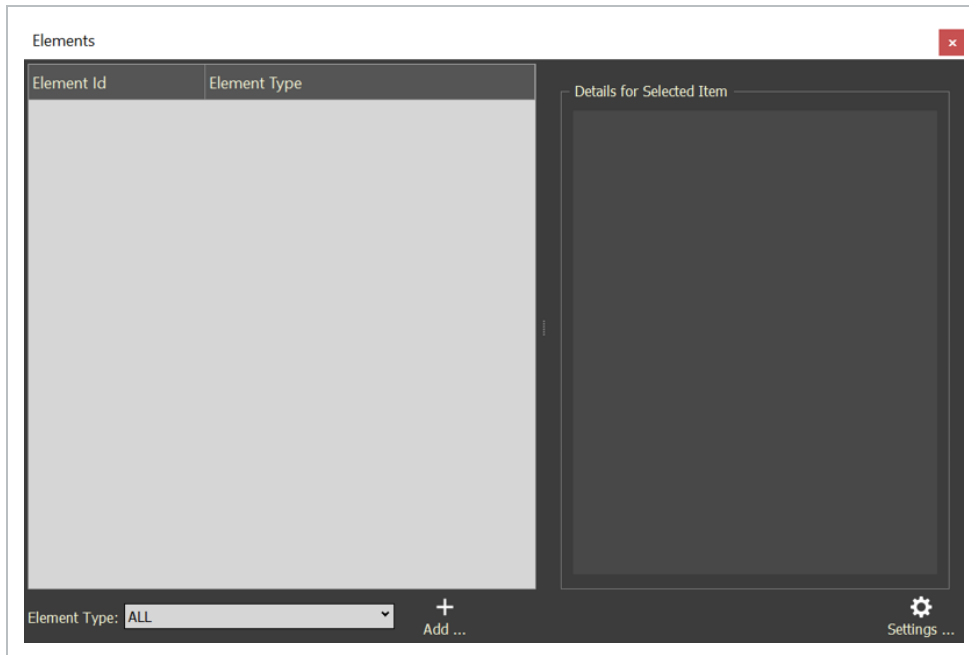

Elements created within the Model application or the Completions application will be displayed.

- **Element Type:** A dropdown selection to filter displayed Elements
- **Add...:** provides the ability to:
 - Create a single Component
 - Create multiple Components from a selection
- **Settings...:** provides the ability to:
 - Toggle on/off the **Auto-select model elements** feature
 - Toggle on/off the **Show linked model elements** feature
 - Toggle on/off the **Drop from Object Tree creates single Material Component** feature
 - Toggle on/off the **Compact Mode** feature

12.2 MANUALLY CREATED ELEMENTS

You can create elements and link tags or objects to those elements by clicking the **Add** icon or moving tags and objects to the Elements panel.

12.2 STEP BY STEP 1 – CREATE AN ELEMENT

1. Click the **Add** icon.

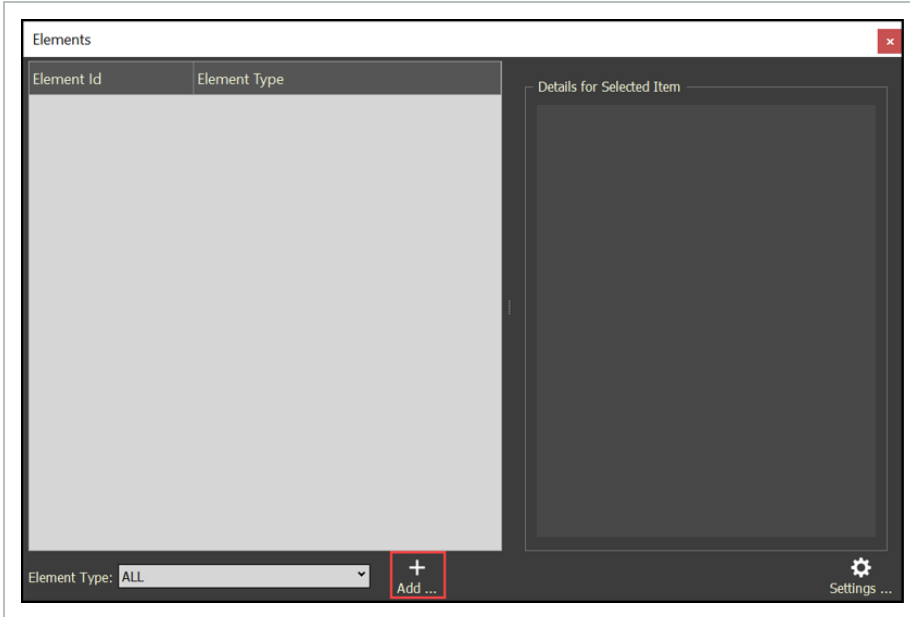

2. Select **Add Component**.

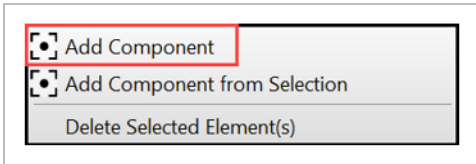

3. Fill in the component fields.

	Field name	Value
1	Element Type	Select Material Component.
2	Element Name	Type in a name that represents the material component to be created.
3	Description	Enter a description for the material component.
4	Linked model item	This is used only when <i>Add Component from Selection</i> option is selected.
5	use Field Mapping	N/A

You can see the new completed component in the Create Element dialog box.

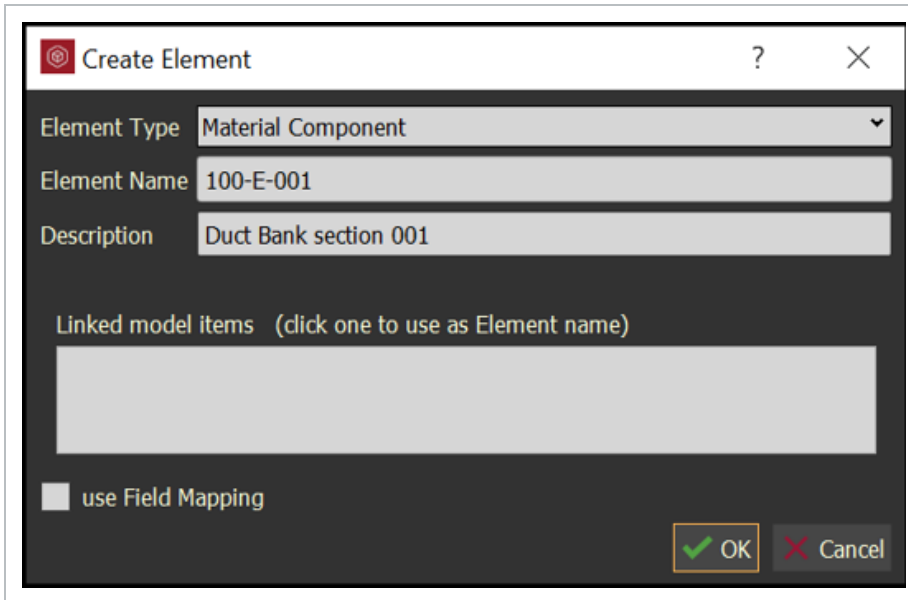

4. Click **OK**, and then the new Material Component shows in the Elements panel.

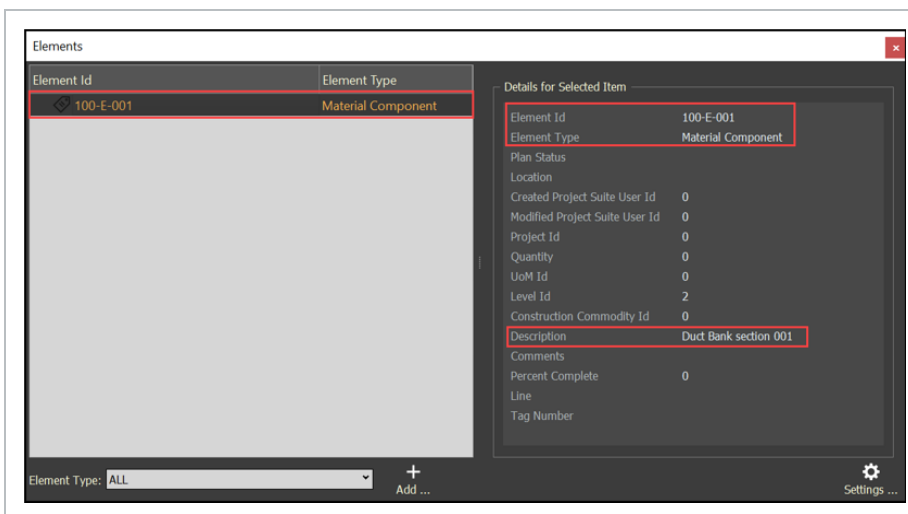

NOTE The Element ID, Element Type, and Description cannot be changed. You must delete and recreate a new element.

5. You can add a model object to the element two different ways:
- Drag one or more tags into the element from the Tags tab.

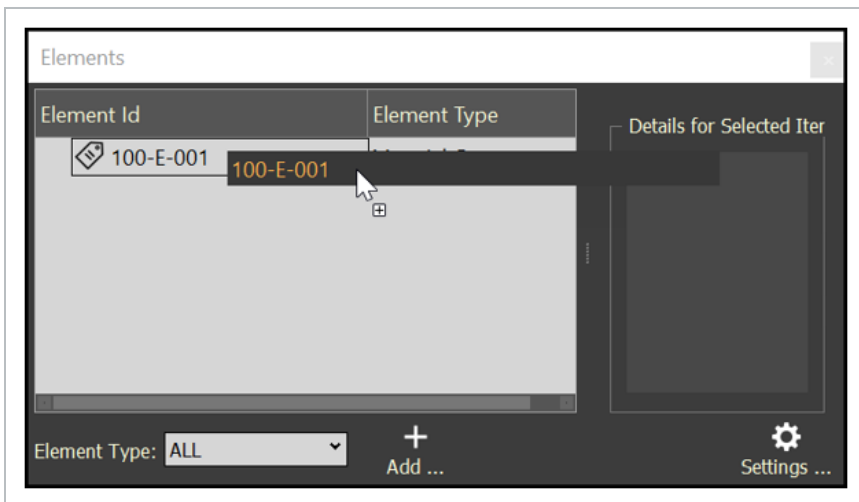

The tags show below the element.

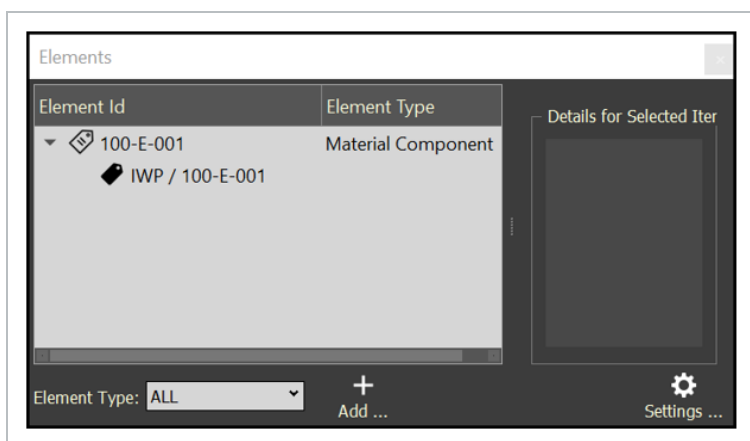

- Drag objects into the element by selecting one or more model objects from the Objects tab.

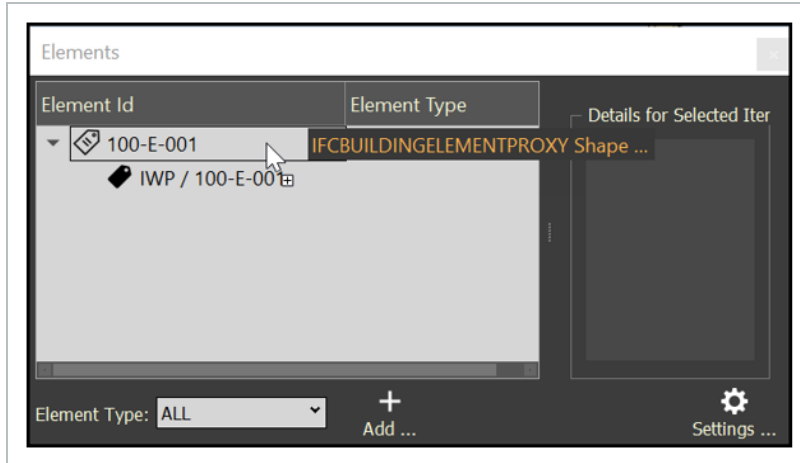

The objects show below the element.

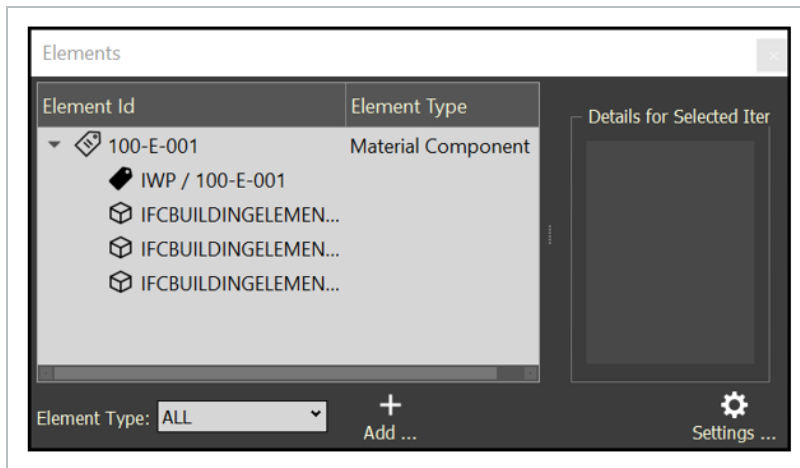

NOTE The object values or tag values are linked to the element. When selecting values in the Elements panel, those values are also selected in the Tags and Objects tree.

12.2 STEP BY STEP 2 – CREATE ELEMENTS FROM A SELECTION OF OBJECTS

1. Select one or more model objects.
2. Click the **Add** icon.

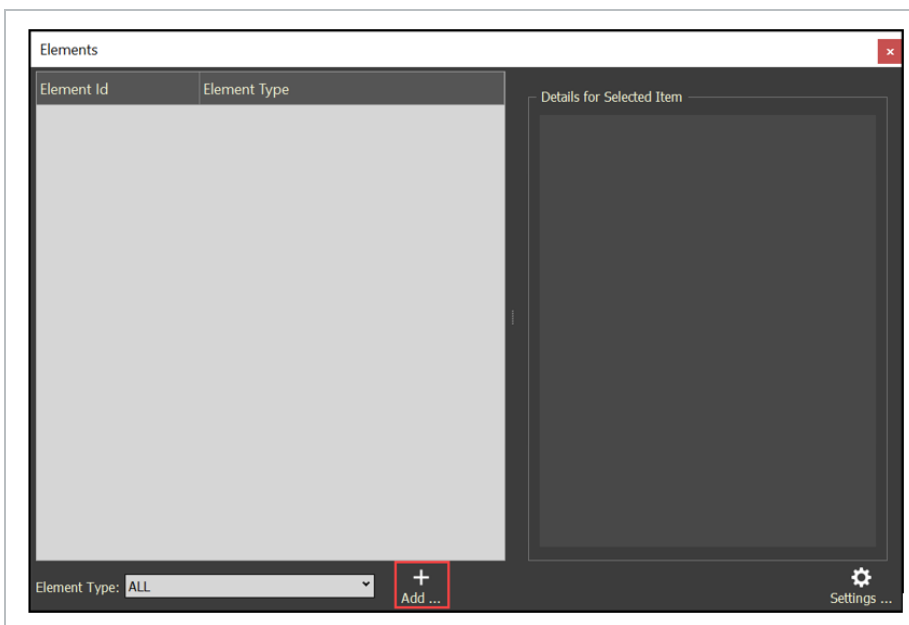

3. Click **Add Components from Selection**.

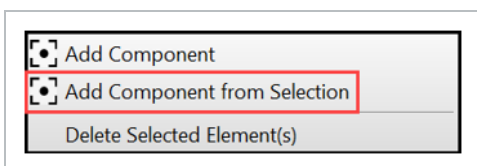

The Create Element dialog box is populated.

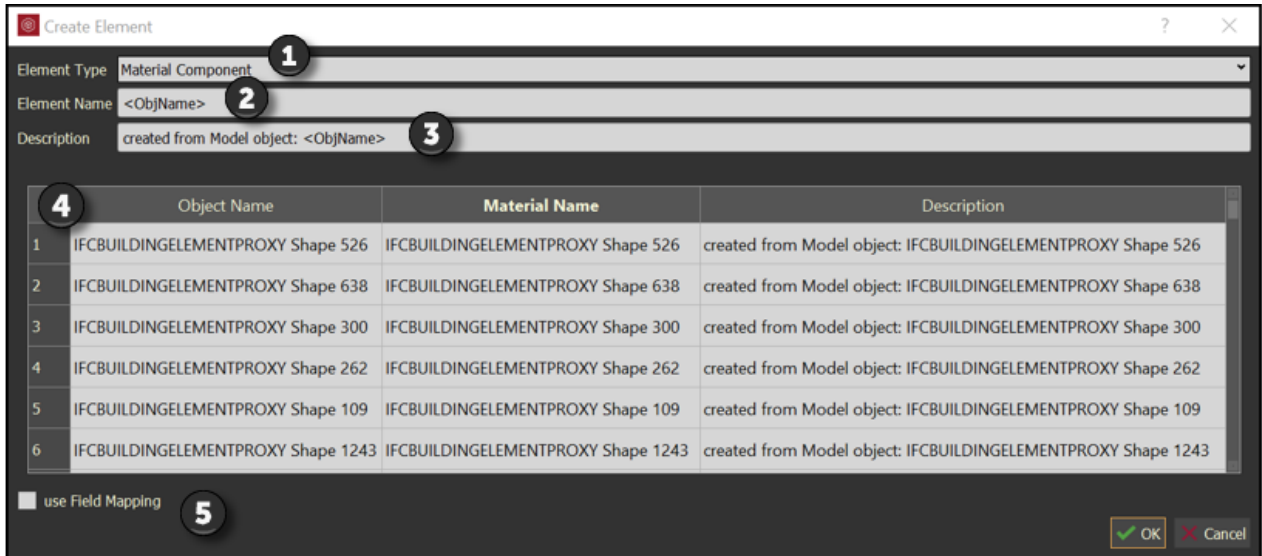

	Field name	Value
1	Element Type	Select Material Component.
2	Element Name	Do not delete <ObjName>. This ensures that all the added objects are unique. You can add any text after the <ObjName> if needed.
3	Description	Optionally type a description for the material component.
4	Linked model items	This is used only when <i>Add Component from Selection</i> option is selected.
5	use Field Mapping	N/A

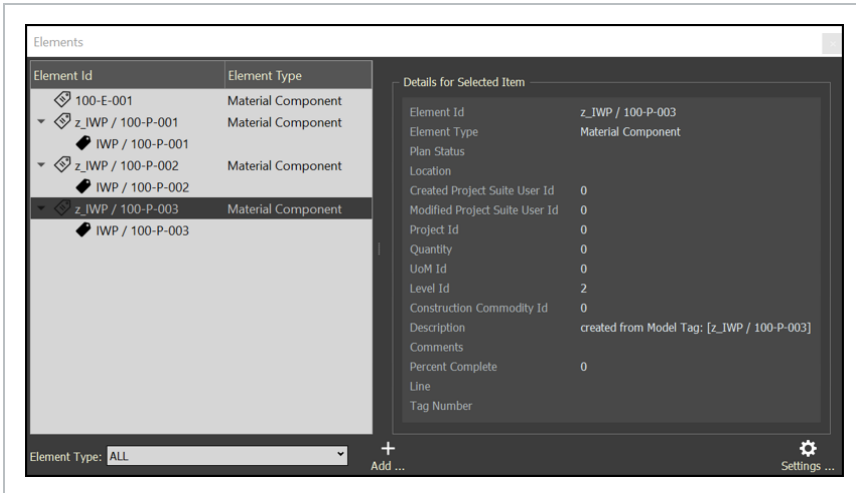

4. Click **OK**, and then the new Elements show in the Elements panel.

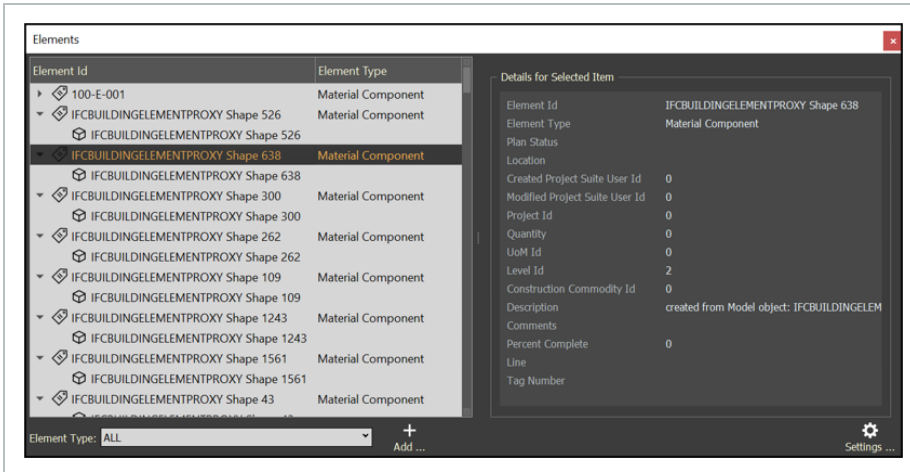

NOTE

Each model object will have an element created with the individual model object linked to that element.

12.2 STEP BY STEP 3 – CREATE ELEMENTS FROM THE TAGS

1. To create elements from tags, in the Tags tab, drag one or more tags into the Elements panel.

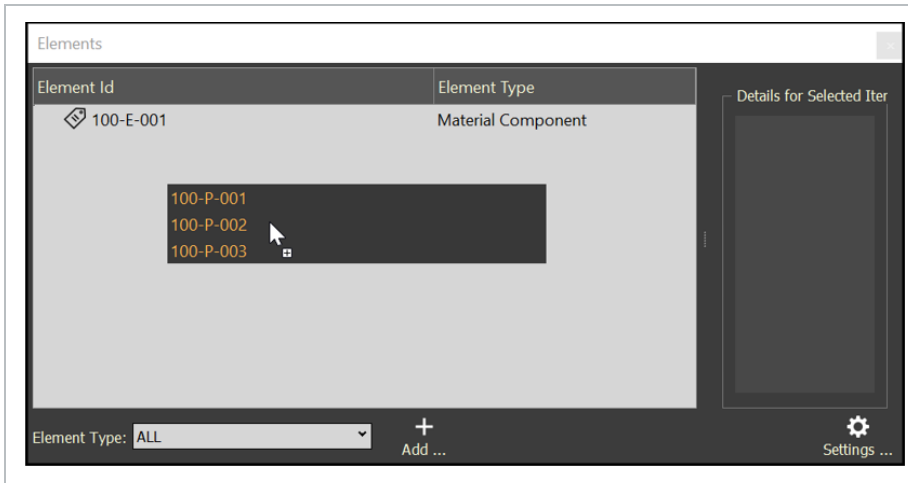

The tags show below the element.

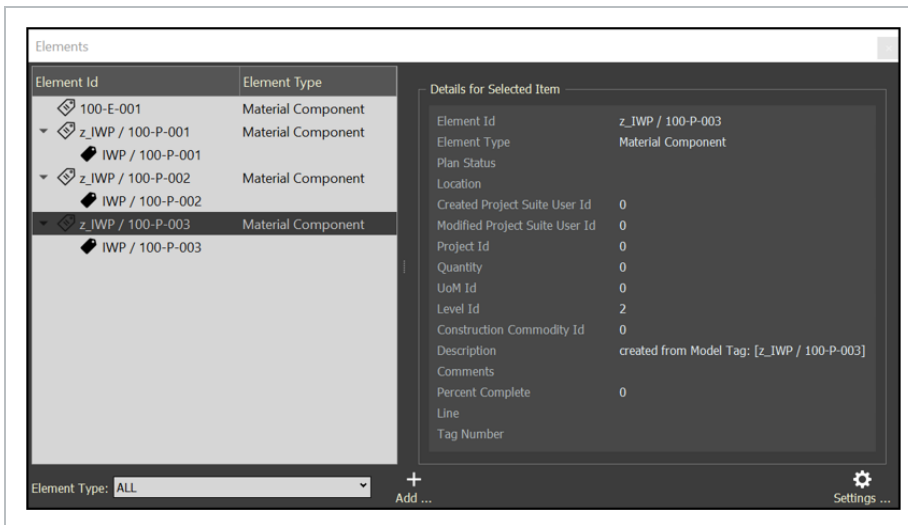

NOTE The element name will be derived from the tag, and the tag value is linked to the respective element.

12.2 STEP BY STEP 4 – EDIT AN ELEMENT

1. In the Elements panel, right-click an element, and then select **Edit Element**.
The Edit Element panel opens and shows the associated element data.
2. Edit the element as needed.

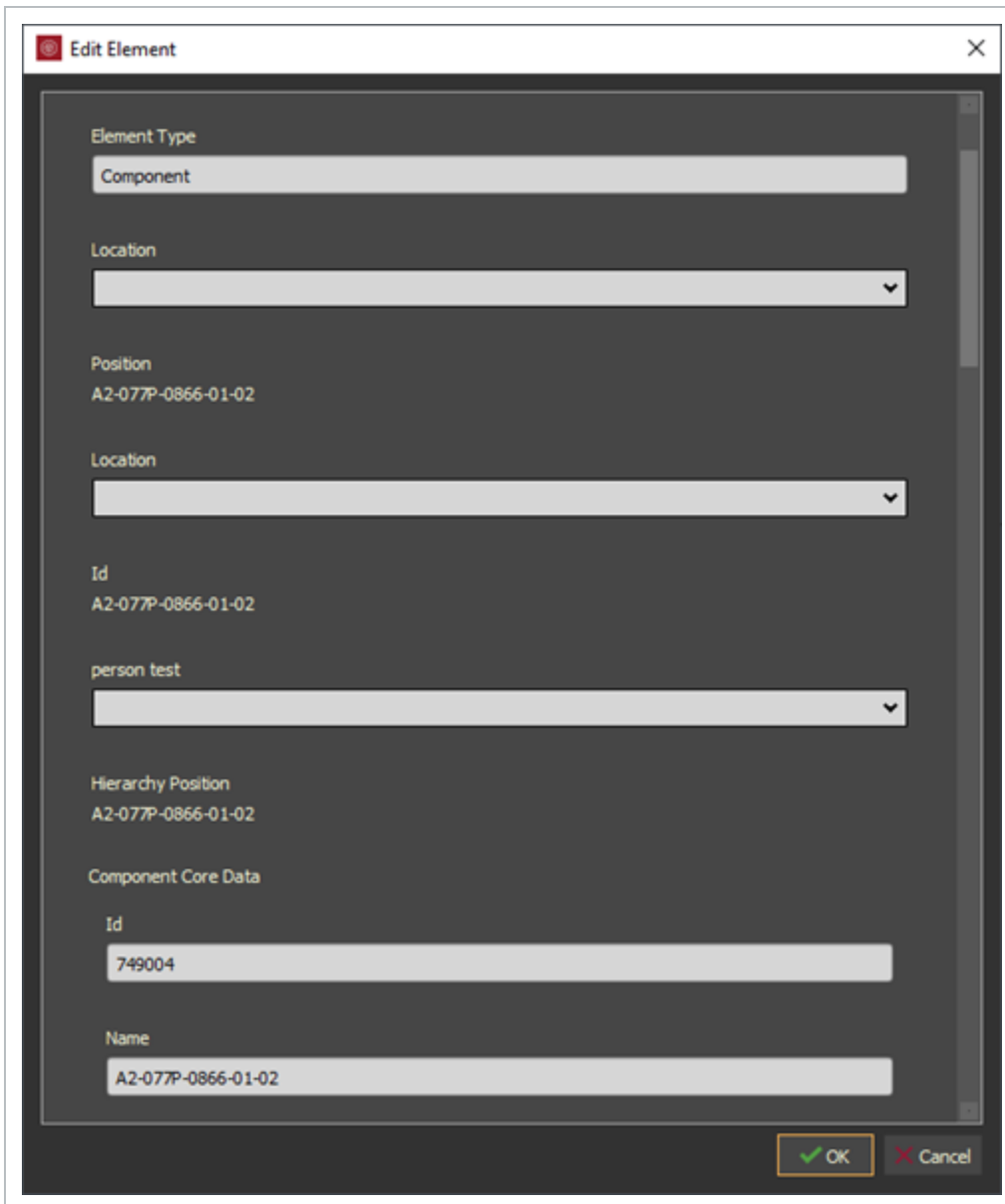

The screenshot shows a dialog box titled "Edit Element" with a close button (X) in the top right corner. The dialog contains several sections of form fields:

- Element Type:** A text field containing "Component".
- Location:** A dropdown menu.
- Position:** A text field containing "A2-077P-0866-01-02".
- Location:** A dropdown menu.
- Id:** A text field containing "A2-077P-0866-01-02".
- person test:** A dropdown menu.
- Hierarchy Position:** A text field containing "A2-077P-0866-01-02".
- Component Core Data:**
 - Id:** A text field containing "749004".
 - Name:** A text field containing "A2-077P-0866-01-02".

At the bottom right of the dialog, there are two buttons: "OK" (with a green checkmark icon) and "Cancel" (with a red X icon).

3. Click **OK** to save your changes. Fields that cannot be edited show in a solid color.

12.2 STEP BY STEP 5 – UNLINK OBJECTS FROM AN ELEMENT

1. Select an object or objects in one or more elements.
2. Right-click on the selected items, and then select **Unlink item**.

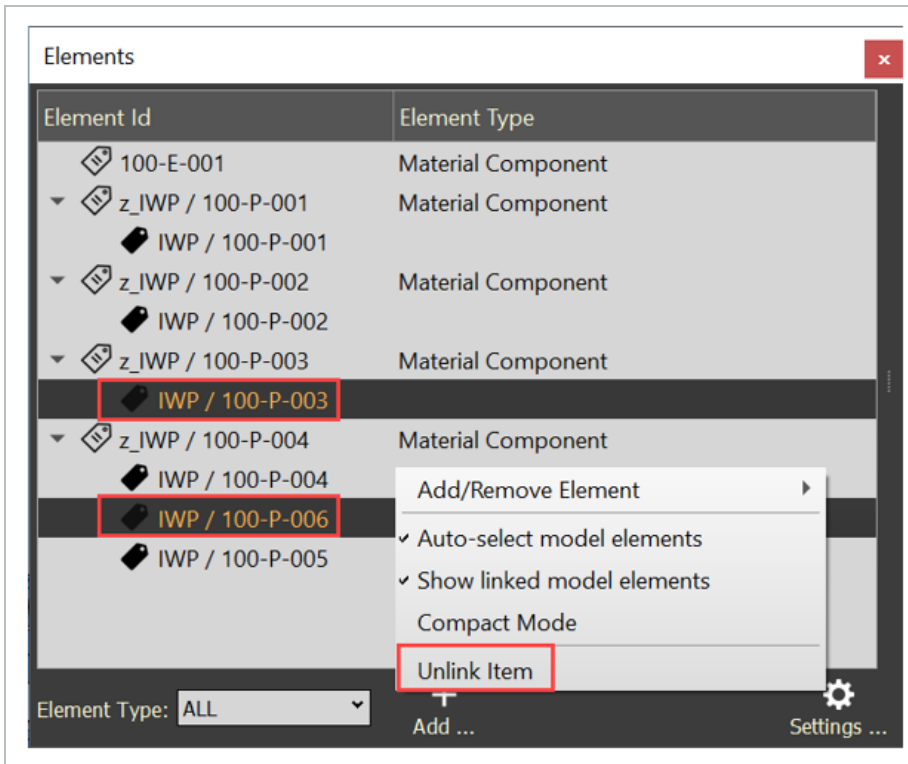

12.2 STEP BY STEP 6 – DELETE AN ELEMENT

1. Select one or more elements.
2. Right-click on the selected items, and then select Add/Remove Element > **Delete Selected Elements**.

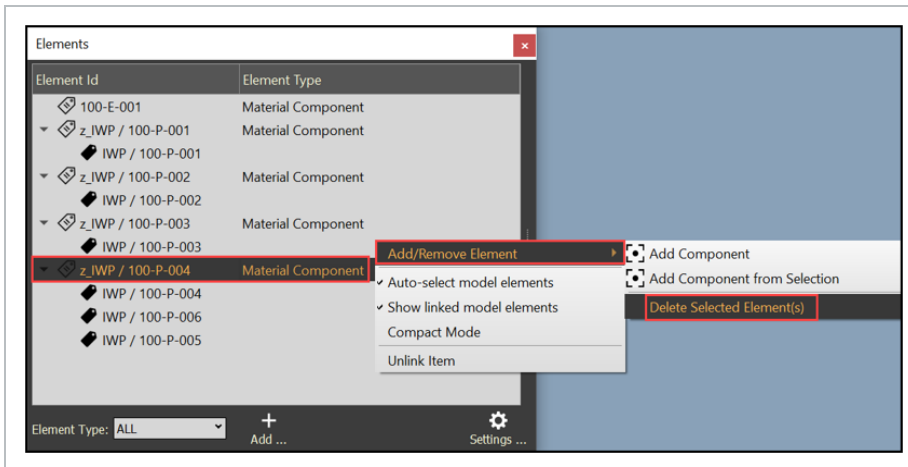

12.3 AUTOMATION OF ELEMENT CREATION - ACTIVITY COMPONENTS

You can automate element creation using DTOs and automatically sync with InEight Plan. When you create elements using DTOs, the DTOs automatically link model objects to elements and creates activity components in Plan.

12.3.1 STEPS

CREATE ELEMENTS AND ACTIVITY COMPONENTS USING DTOS

1. On the DTO tab, add a DTO.
2. On the Selector tab, find the model objects to create elements and activity components.

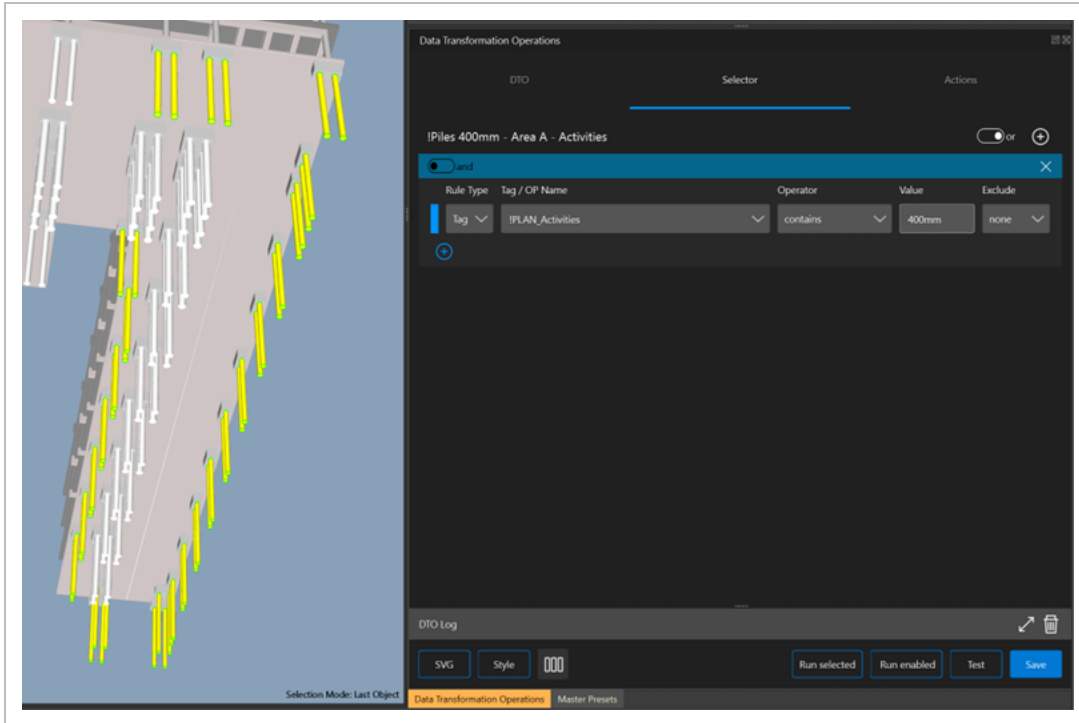

- In the Actions tab, select **Element** for Action, and then use the following criteria:

Mode	Create
Element Type	Component
Component Type	Activity
Tag Category	Select a tag that uses values to create elements in Model and activity components in Plan.

- Click **Configure**, and then add rule types to select metadata to create activity components in Plan.
- Click the **Add row** icon to add a new Rule Type, and then use the following criteria:

The tables below are recommended rule types that provide the minimum information. Tables within the Table Name drop-down fields show data that aligns with Plan, Control, and Platform data. In the Table Name, select Component Core Data to use the minimum required data to create an activity component.

12.3.1.1 USING CLAIMINGScheme ID FOR FIELD NAME

Table Name	Component Core Data
Field Name	ClaimingScheme Id
Rule Type	Constant
Constant Value	This field integrates with Plan. Select the applicable claiming scheme for the model objects selected.
Operator	=

12.3.1.2 USING DESCRIPTION FOR FIELD NAME

Table Name	Component Core Data
Field Name	Description
Rule Type	Tag
Tag Name	Select an applicable tag name for the model object description.
Operator	=

12.3.1.3 USING DISCIPLINE ID FOR FIELD NAME

Table Name	Component Core Data
Field Name	Discipline Id
Rule Type	Constant
Constant	This field integrates with Plan. Select the applicable discipline for the

Value model objects selected.

Operator =

12.3.1.4 USING QUANTITY FOR FIELD NAME

Table Name Component Core Data

Field Name Quantity

Rule Type Tag

Tag Name Select an applicable tag name to sum quantities

Operator SUM

12.3.1.5 USING UOM FOR FIELD NAME

Table Name Component Core Data

Field Name UoM Id

Rule Type Constant

Constant Value This field integrates with Platform. Select the applicable UoM that aligns with the WBS.

Operator =

12.3.1.6 USING WBS ID FOR FIELD NAME

Table Name Component Core Data

Field Name WBS Id

Rule Type Constant

Constant Value This field integrates with Control. Select the applicable WBS for the model objects selected.

Operator =

6. Click **OK** to save your configuration.
7. On the DTO tab, click **Save**.
8. Select File > **Save Project** to save your project changes.
9. On the DTO tab, click **Run selected** to create elements with the configured information and automatically link the model objects to the elements. The image below is an example of new element with the configured data:

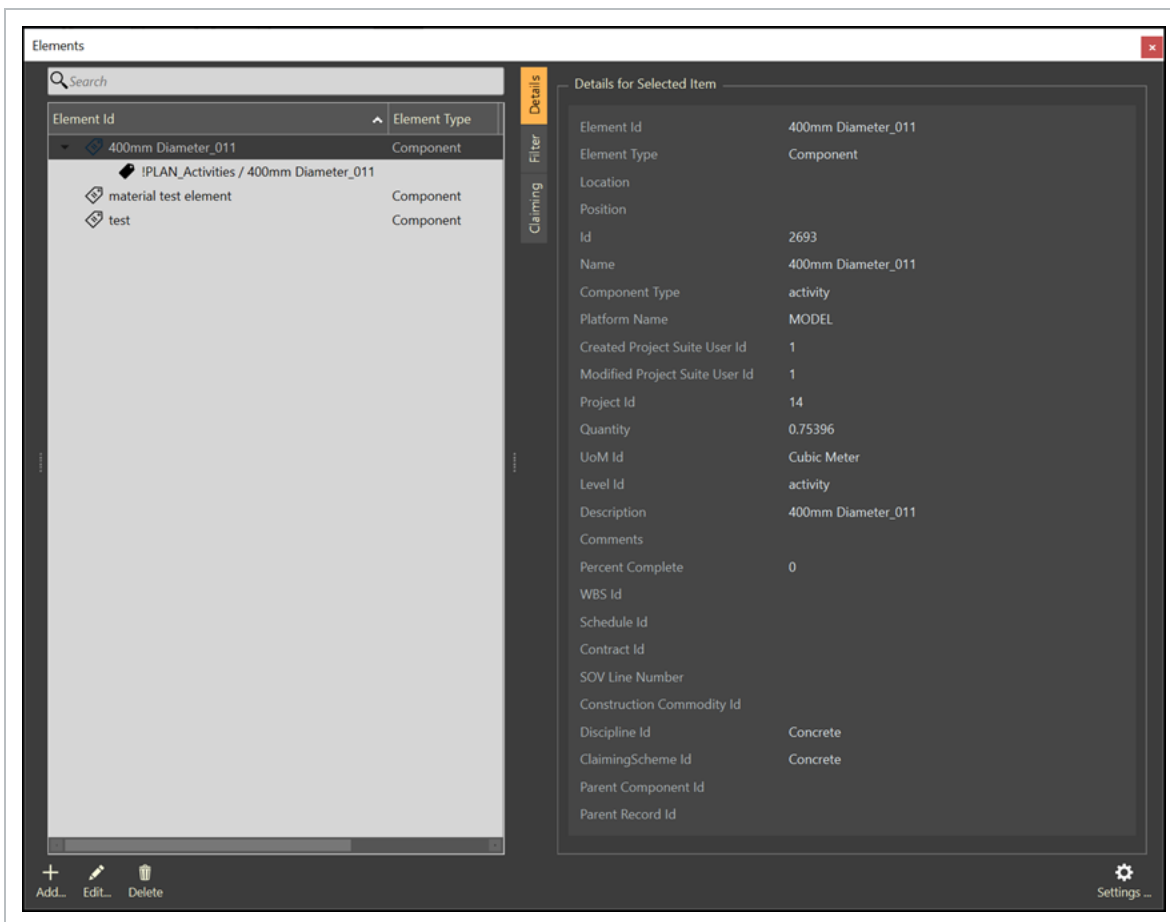

10. Click File > **Save Project** to create activity components in Plan. A notification is sent to Model from Plan notifying you whether the components are created or rejected.

12.3.2 CONSIDERATIONS

- The Model environment must be integrated with InEight Platform.
- Customer has purchased Model and Plan.

12.4 AUTOMATION OF ELEMENT CREATION - MATERIAL COMPONENTS

You can automate element creation using DTOs and automatically sync with InEight Plan. When you create elements using DTOs, the DTOs automatically link model objects to elements and creates material components in Plan.

12.4.1 STEPS

CREATE ELEMENTS AND MATERIAL COMPONENTS USING DTOS

1. On the DTO tab, add a DTO.
2. On the Selector tab, find the model objects to create elements and material components.

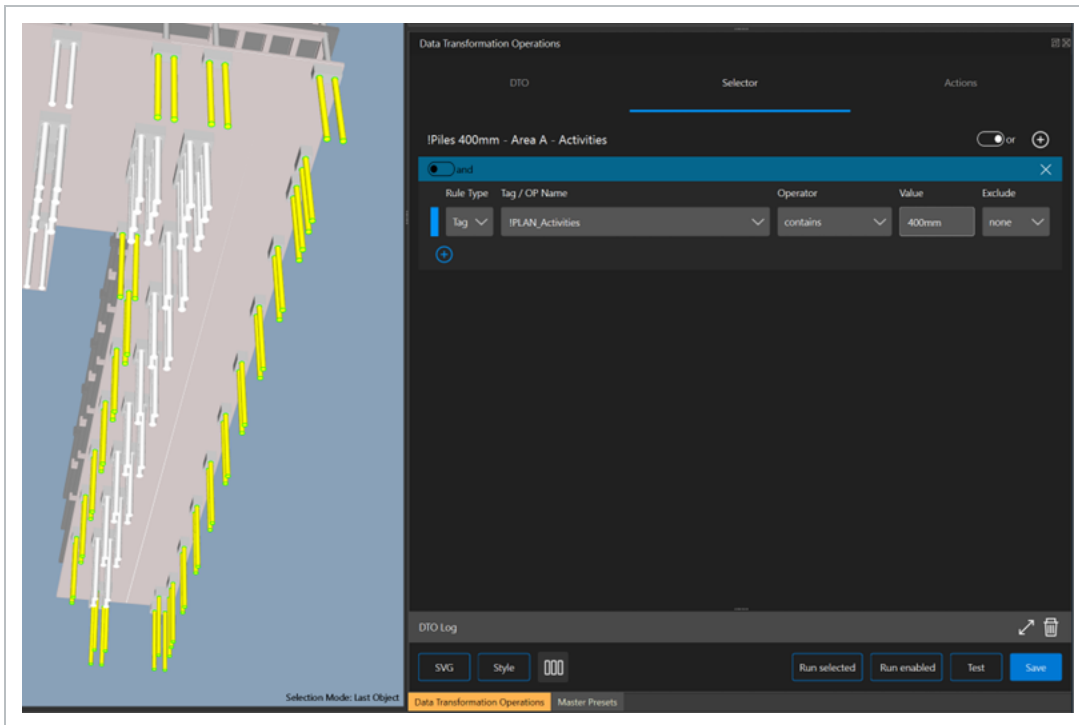

- On the Actions tab, select **Material** for Action, and then use the following criteria:

Mode	Create
Element Type	Component
Component Type	Material
Tag Category	Select a tag that uses values to create elements in Model and material components in Plan.

- Click **Configure**, and then add rule types to select metadata to create material components in Plan.
- Click the **Add row** icon to add a new Rule Type, and then use the following criteria:
 The table and image below show an example of a rule type. Tables in the Table Name drop-down field show data that aligns with Plan data. There is no minimum required data to create material components.

Table Name	Component Core Data
Field Name	Description
Rule Type	Tag
Tag Name	This field integrates with Plan. Select the applicable description for the model objects selected.
Operator	=

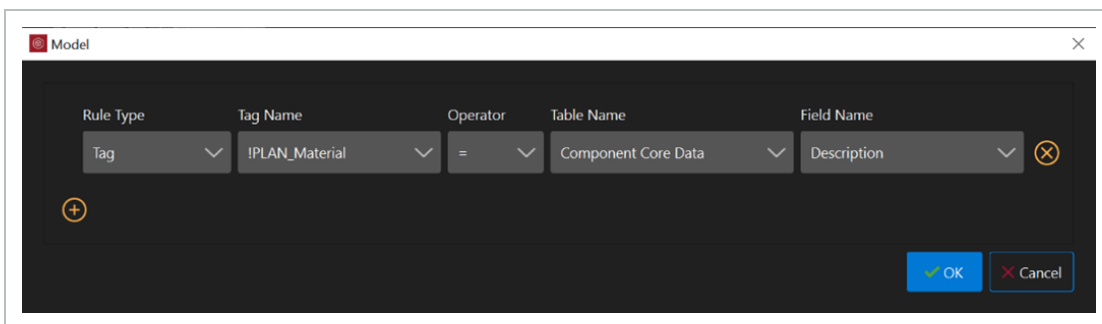

6. Click **OK** to save your configuration.
7. On the DTO tab, click **Save**.
8. Select File > **Save Project** to save your project changes.
9. On the DTO tab, click **Run selected** to create elements with the configured information and automatically link the model objects to the elements. The image below is an example of new element with the configured data:

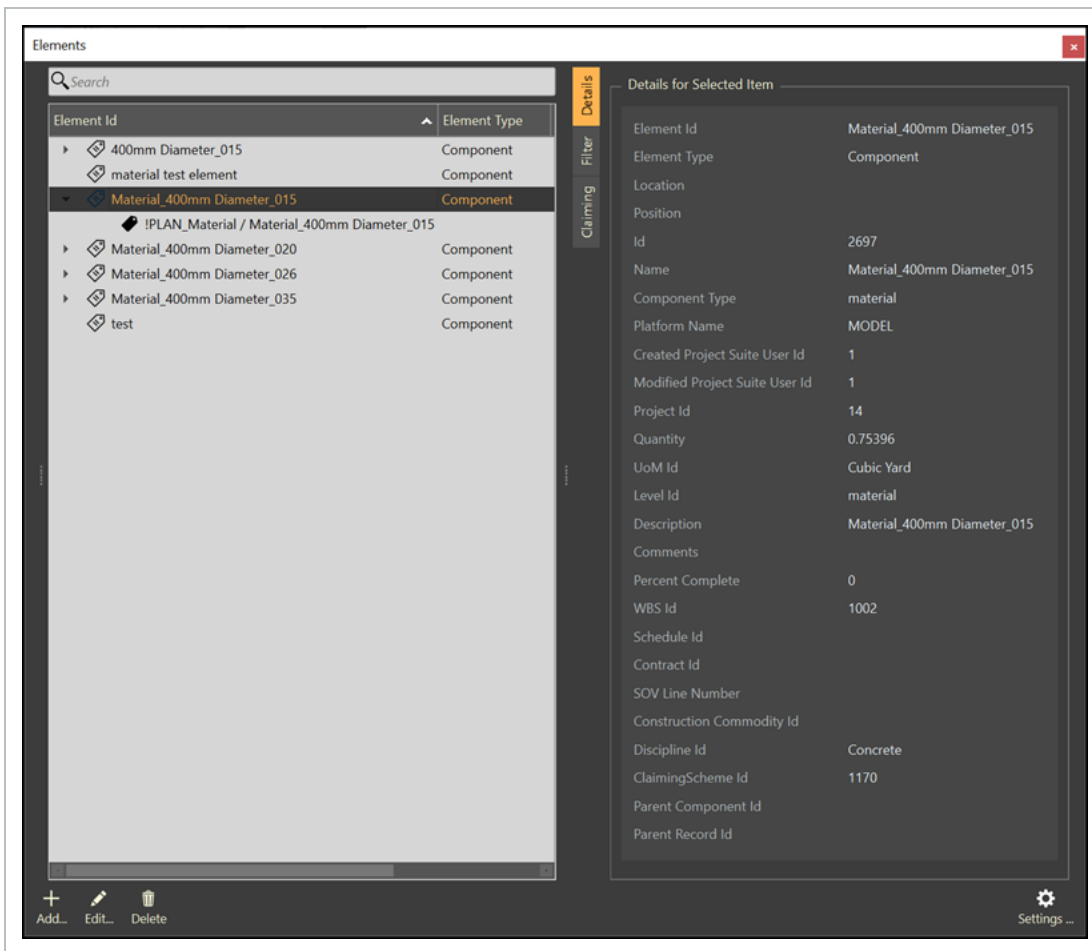

- Click File > **Save Project** to create activity components in Plan. A notification is sent to Model from Plan notifying you whether the components are created or rejected.

12.4.2 CONSIDERATIONS

- The Model environment must be integrated with InEight Platform.
- Customer has purchased Model and Plan.

12.5 AUTOMATION OF ELEMENT CREATION - AGGREGATE COMPONENTS

You can automate element creation using DTOs and automatically sync with InEight Plan. When you create elements using DTOs, the DTOs automatically link model objects to elements and creates

assemblies in Plan.

NOTE Aggregate components in Model integrate with assembly components in Plan.

12.5.1 STEPS

CREATE ELEMENTS AND AGGREGATE COMPONENTS USING DTOS

1. On the DTO tab, add a DTO.
2. On the Selector tab, find the model objects to create elements and aggregate components.

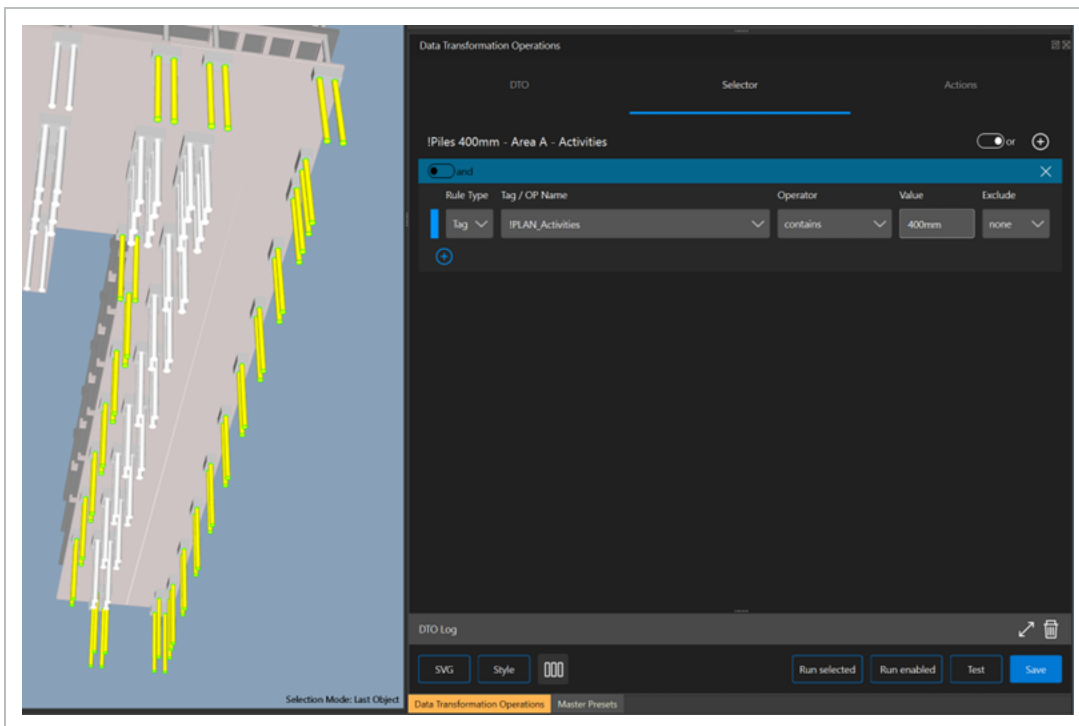

3. On the Actions tab, select **Element** for Action, and then use the following criteria:

Mode	Create
Element Type	Component
Component	Aggregate

Type	
Tag Category	Select a tag that uses values to create elements in Model and assembly components in Plan.

- Click **Configure**, and then add rule types to select metadata to create assembly components in Plan.
- Click the **Add row** icon to add a new Rule Type, and then use the following criteria:

The table and image below show an example of a rule type. Table names within the Table Name drop-down field show data that aligns with Plan data. There is no minimum required data to create material components.

Table Name	Component Core Data
Field Name	Description
Rule Type	Tag
Tag Name	This field integrates with Plan. Select the applicable description for the model objects selected.
Operator	=

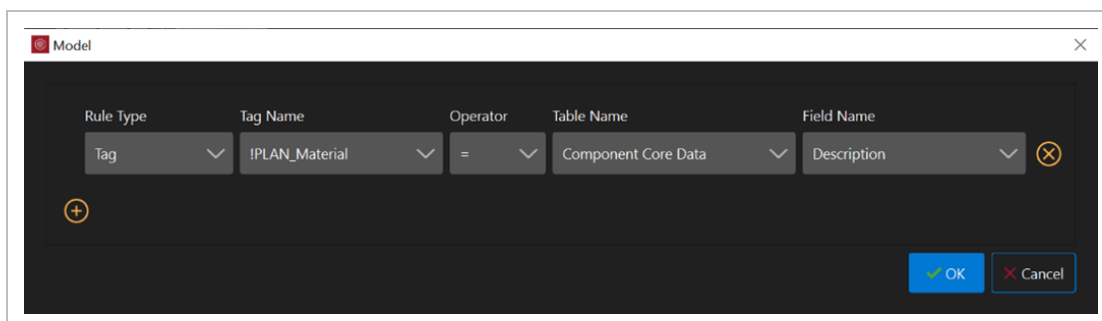

- Click **OK** to save your configuration.
- On the DTO tab, click **Save**.
- Select File > **Save Project** to save your project changes.

- On the DTO tab, click **Run selected** to create elements with the configured information and automatically link the model objects to the elements. The image below is an example of new element with the configured data:

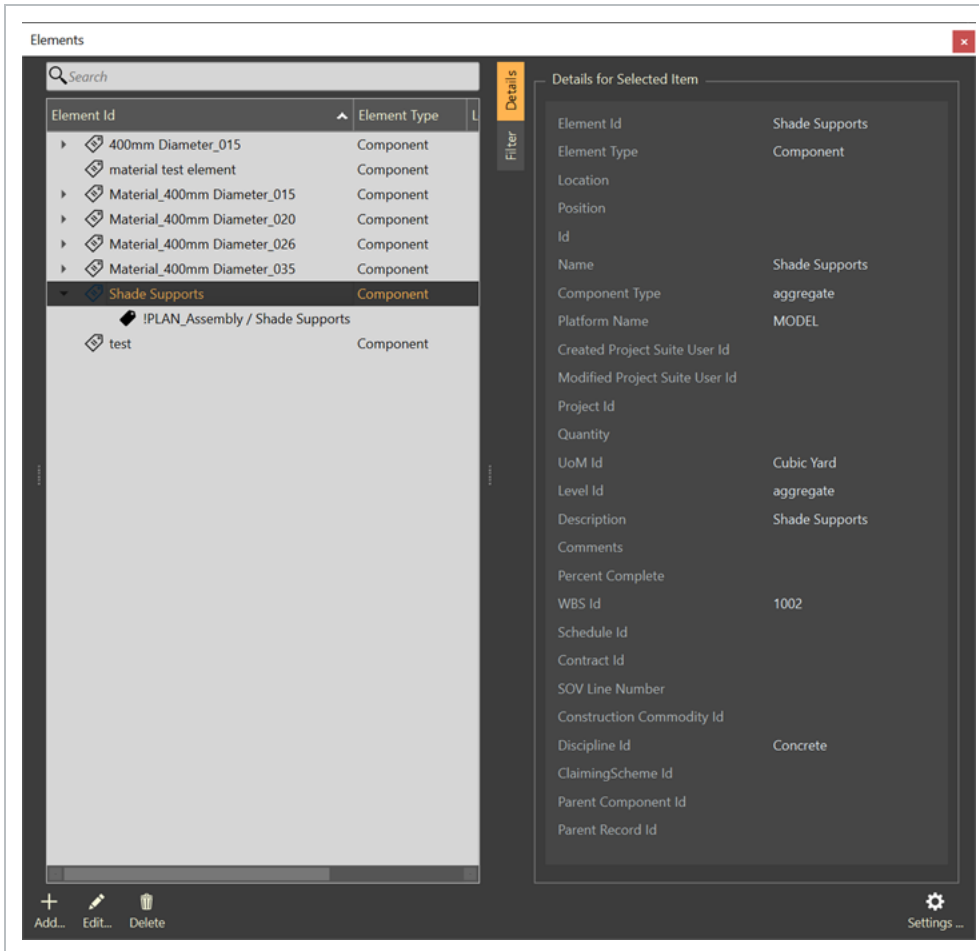

- Click File > **Save Project** to create activity components in Plan. A notification is sent to Model from Plan notifying you whether the components are created or rejected.

12.5.2 CONSIDERATIONS

- The Model environment must be integrated with InEight Platform.
- Customer has purchased Model and Plan.

12.6 QUANTITY CLAIMING

You can perform component claiming and sync changes with InEight Plan. You can mark the completion of claiming schemes in full or enter a partial install quantity.

The following image shows claiming in the Elements panel:

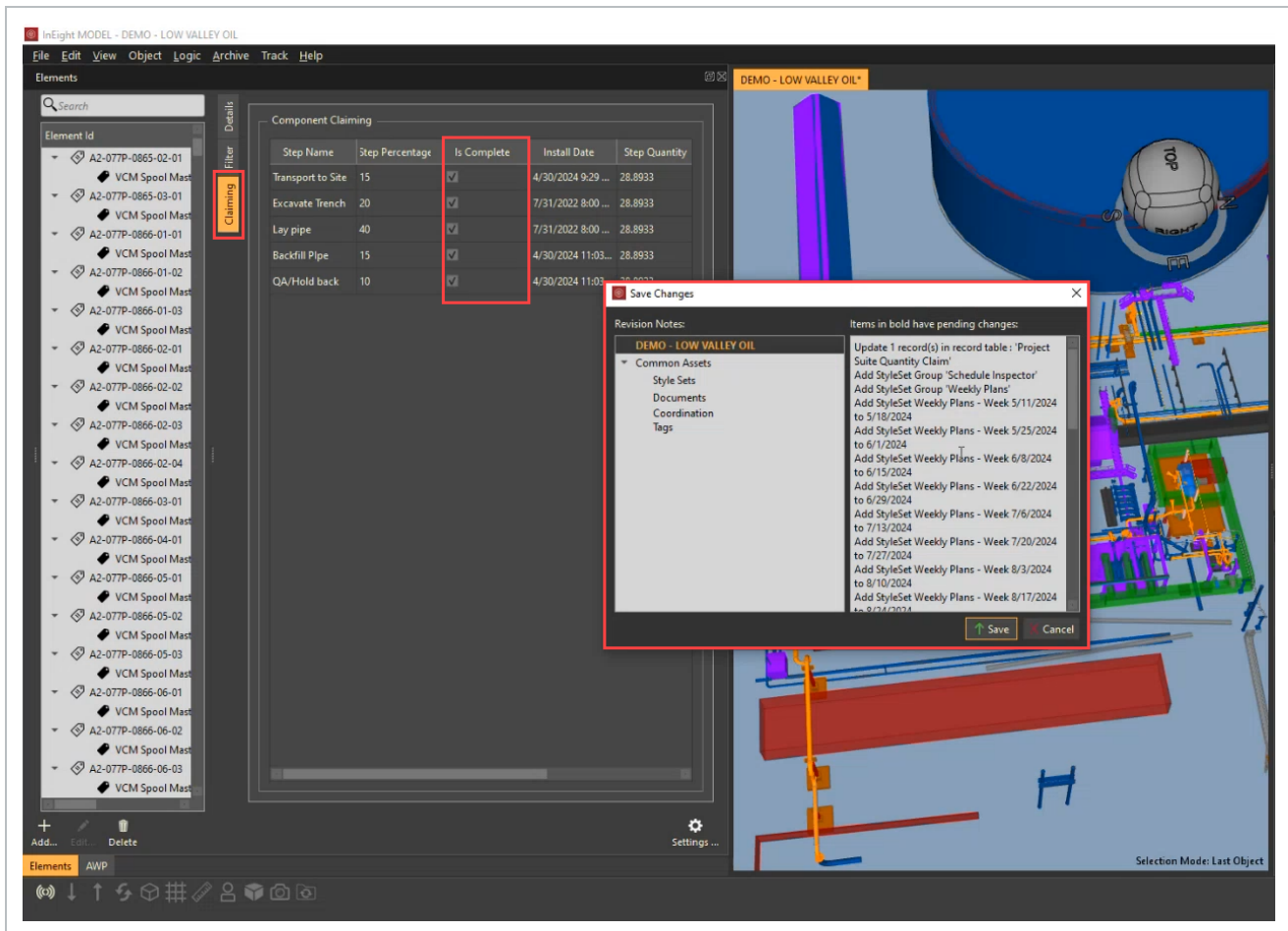

12.6.1 STEPS

- **Is Complete** – Mark the item's checkbox to do a complete claiming.
- **Install Quantity** – Click in the Install Quantity field, and then enter the partial quantity you want to claim.
- **Save Changes** – Click File > **Save Project** to save your changes and sync with Plan. When you select Save Project, a Save Changes dialog box shows with the pending updates. Click **Save** to

sync the changes with Plan.

- **Project updates** – When the sync to Plan is complete, a You have project updates banner shows at the bottom left of the panel. The Project updates icon's color at the bottom of the panel also turns to green. You must click the Project updates icon, and then select **Update Now** to update Model.

12.6.2 CONSIDERATIONS

Reverse claiming must be done in the Plan application. After you reverse claiming quantities in Plan, changes will sync in Model.

LESSON 12 REVIEW

1. The Material created are linked to the AWP process.
 - a. True
 - b. False

2. Elements have more _____ than Assets in that they have a _____ relationship and display different data based on Element type.
 - a. information, variety
 - b. flexible, hierarchical
 - c. relationship, classification

3. Elements formalize relationships between these: (select all that apply)
 - a. tags
 - b. components
 - c. equipment
 - d. assets
 - e. data
 - f. systems
 - g. subsystems

LESSON 12 SUMMARY

As a result of this lesson, you can:

- Navigate the Elements panels and dialogs
- Know how to create an Element
- Create Elements from objects
- Unlink objects from an Element
- Delete an Element

CHAPTER 13 – ADVANCED WORK PACKAGING & WORKFACE PLANNING

13.1 WORK PACKAGING OVERVIEW

InEight Model allows visual work packaging to support an Advanced Work Packaging (AWP), Work Face Planning (WFP), or any other work scoping process.

Work Packaging breaks down projects into small, manageable scopes of work so that operation can be assigned to responsible supervision, executed, and tracked effectively. Within InEight, our approach is to break the work of your project into Construction Work Areas (CWAs), Construction Work Packages (CWPs), and Installation Work Packages (IWPs).

AWP activities span the entire project. Front-end planning and detailed engineering activities support enhanced execution at the work front. Project set-up and planning sessions establish the basis for coordinated construction, procurement, and engineering work packages (CWPs, PWPs, and EWPs).

AWP drives the WFP concepts to Engineering and Procurement. Drawings are issued to construction and vendors as complete Engineering Work Packages (EWP) and Procurement Work Packages (PWP) instead of individual drawing releases. The objective is to ensure all parties follow the project Path of Construction.

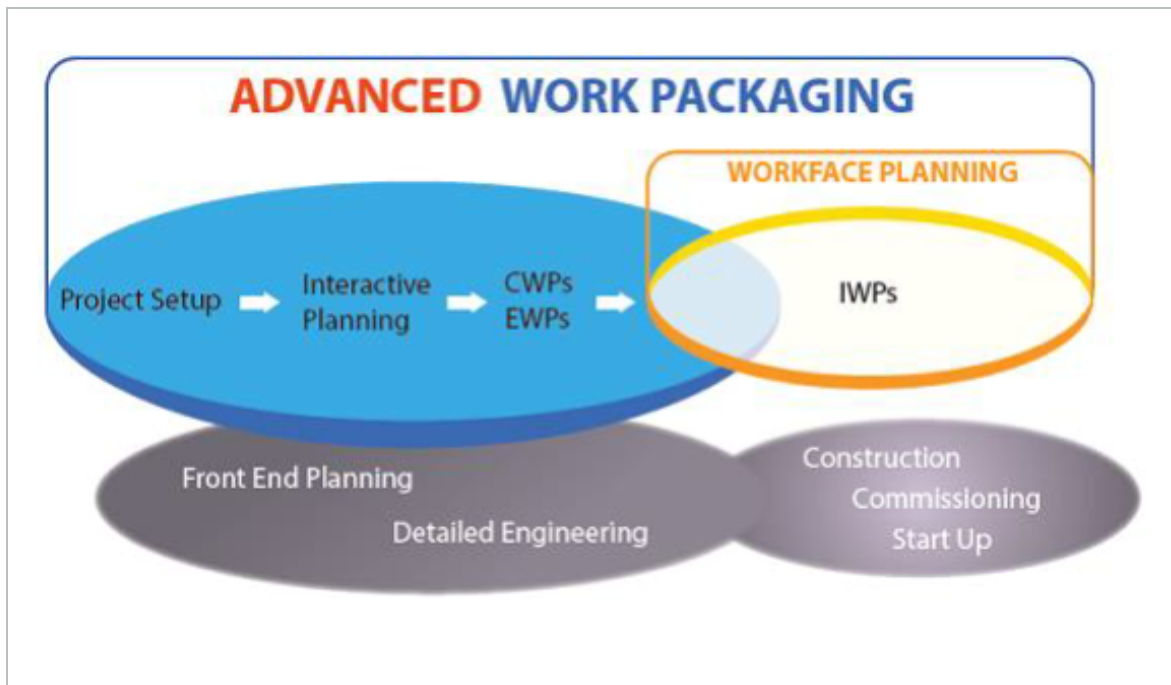

13.1.1 AWP PANEL

To access the AWP Panel, select View from the menu bar at the top of the screen, and then select **AWP**.

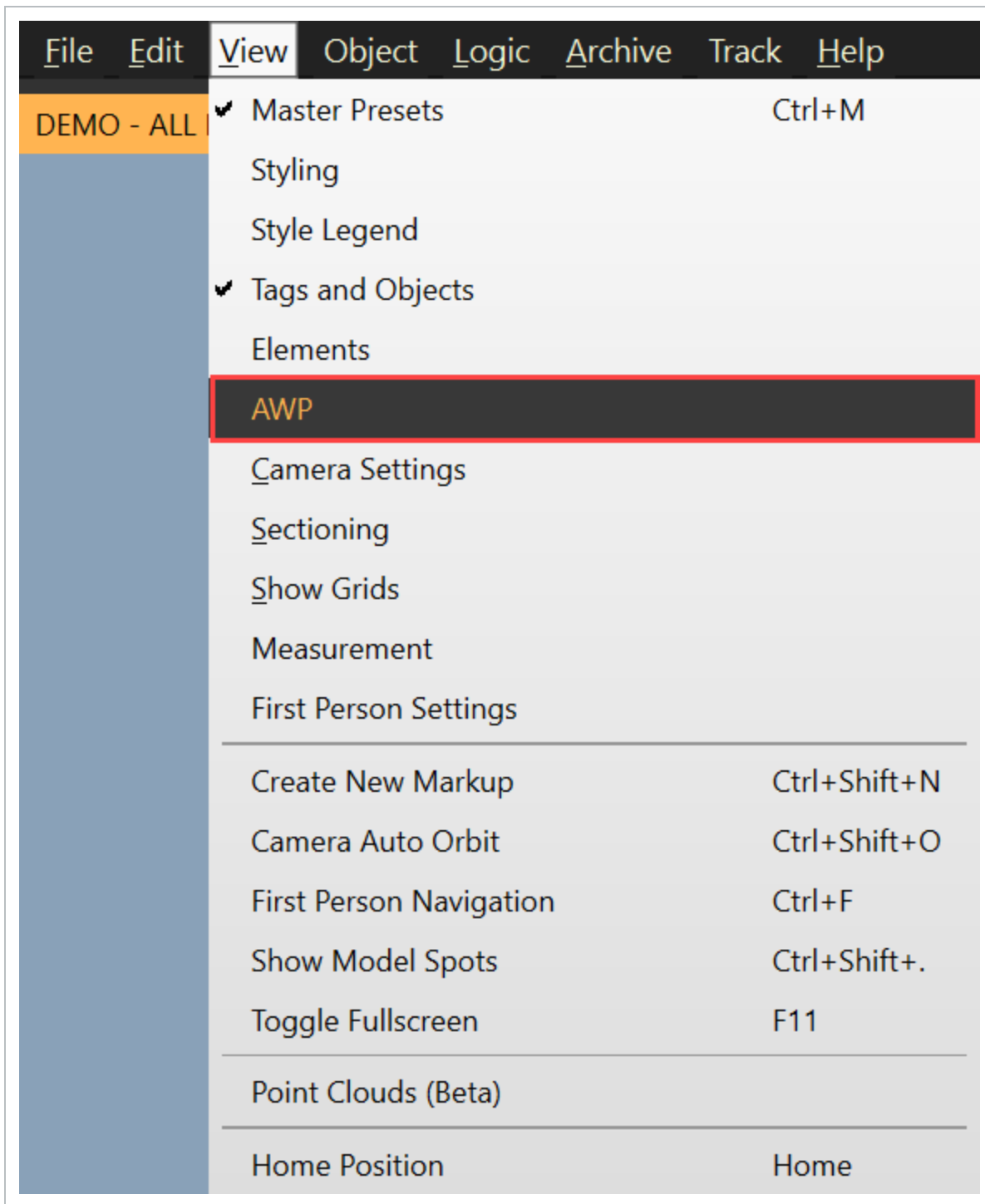

This opens the AWP Panel.

- AWP Panel will display Work Packaging structure items (CWA, CWP, IWP) created in InEight Model, InEight Plan, or InEight Schedule applications
- Name: Work Package unique name or code

- Description: Brief work package description
- Start: Schedule start date
- Finish: Schedule finish date
- % Complete: Percent complete (earned work-hour basis)
- Platform: Identifies which platform (Model, Plan, Schedule) created work package structure item
- Add: provides the ability to:
 - Add CWA
 - Add CWP
 - Add IWP
 - Remove Item
- Settings: provides the ability to:
 - Toggle on/off the Auto-select material components feature
 - Visually select model objects that are assigned to work package structure
 - Toggle on/off the Show % complete feature
 - Activates progress visualization mode
 - Toggle on/off the Compact Mode feature
 - Reduces AWP panel down to only show CWA/CWP/IWP names
 - Toggle on/off the Edit RUID feature
 - Opens the AWP panel column customization widget

13.2 CREATING & MANAGING CWA, CWP & IWP

The InEight platform allows users to generate AWP structure components (Construction Work Areas (CWAs), Construction Work Packages (CWPs), and Installation Work Packages (IWPs)) within Schedule, Plan, and Model. InEight's cloud-based platform allows real-time synchronization between the solutions.

Adding to the existing AWP structure or creating a new structure to reflect the current project status is available in the Model.

13.2 STEP BY STEP 1 – CREATE A CONSTRUCTION WORK AREA (CWA)

1. Select **Add**.

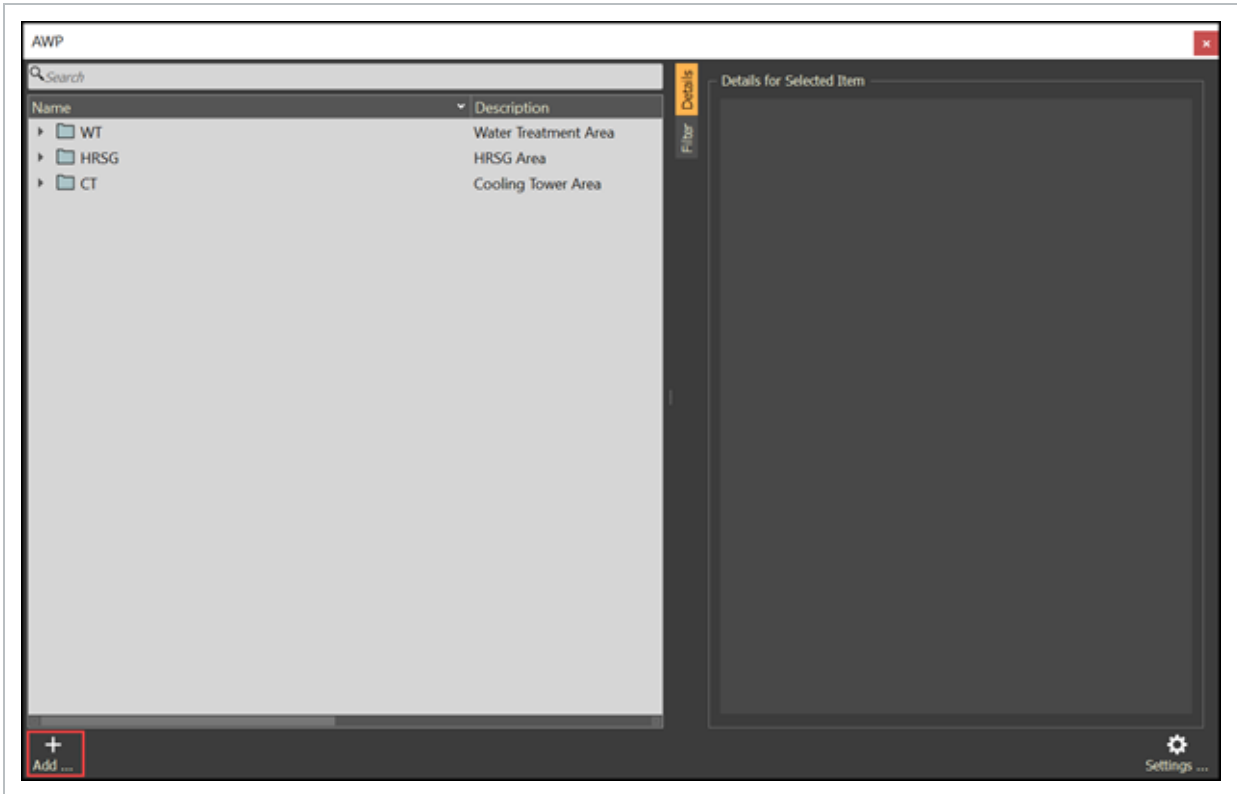

2. Click **Add CWA**.

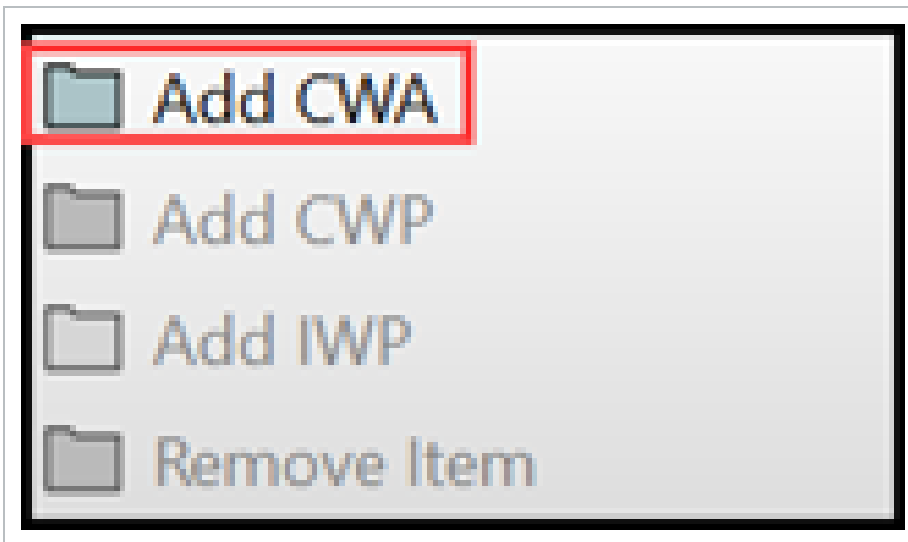

- Fill out the CWA ID (project unique code or identifier).

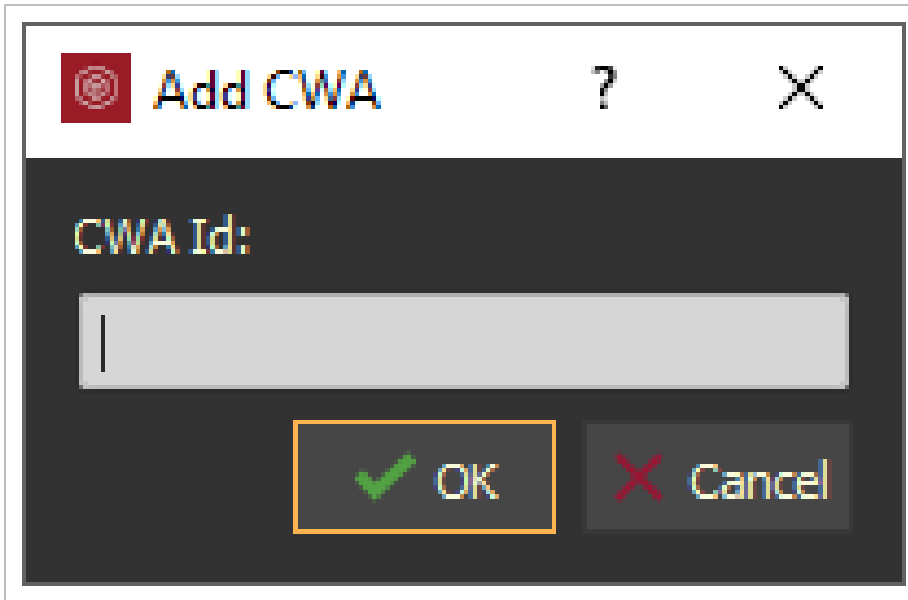

The screenshot shows a dialog box titled "Add CWA". It features a search icon, a question mark, and a close button in the top right. The main content area contains the label "CWA Id:" and a text input field. At the bottom, there are two buttons: "OK" (with a green checkmark) and "Cancel" (with a red X). The "OK" button is highlighted with an orange border.

- Click **OK**, then the new CWA will display within the AWP panel.

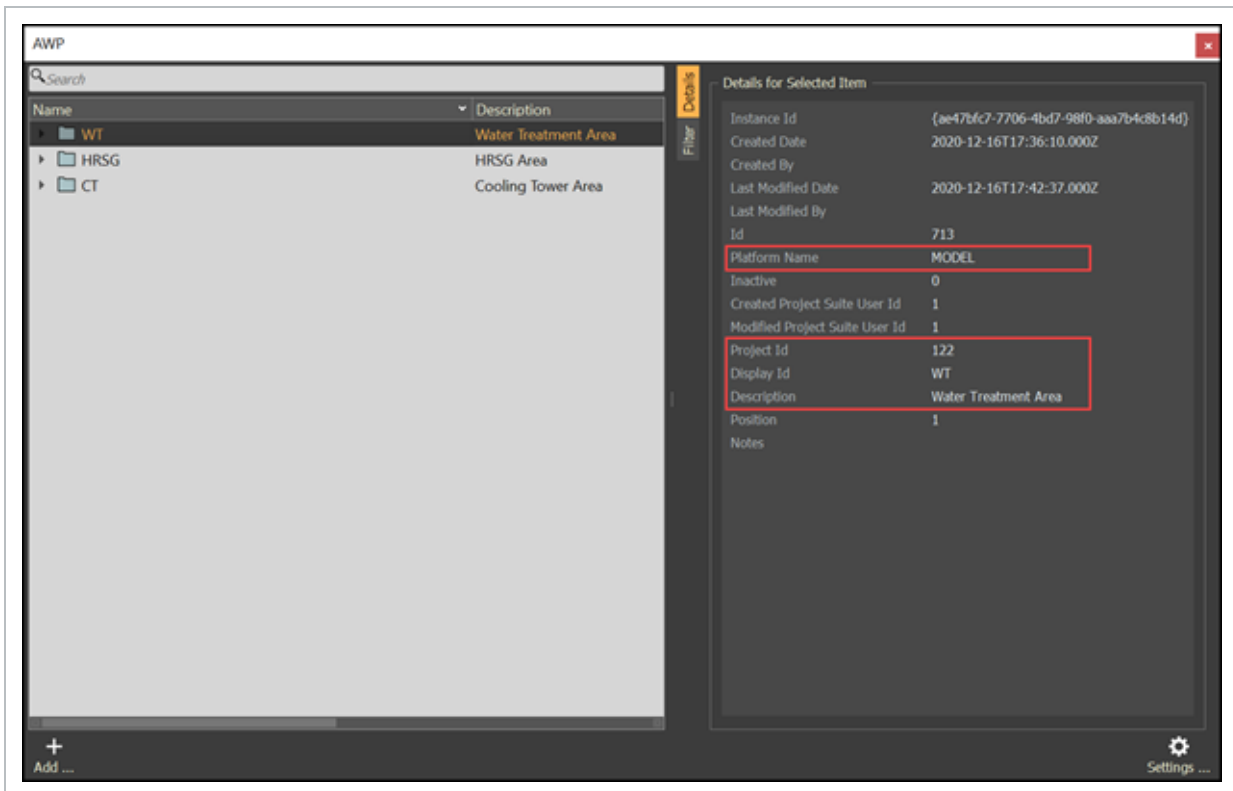

The screenshot shows the AWP (Asset Work Panel) interface. The left pane displays a tree view with the following structure:

Name	Description
WT	Water Treatment Area
HRSG	HRSG Area
CT	Cooling Tower Area

The right pane shows the "Details for Selected Item" for the "WT" area. The following fields are highlighted in red:

Field	Value
Instance Id	{ae47efc7-7706-4bd7-98f0-aaa7b4c8b14d}
Created Date	2020-12-16T17:36:10.000Z
Created By	
Last Modified Date	2020-12-16T17:42:37.000Z
Last Modified By	
Id	713
Platform Name	MODEL
Inactive	0
Created Project Suite User Id	1
Modified Project Suite User Id	1
Project Id	122
Display Id	WT
Description	Water Treatment Area
Position	1
Notes	

NOTE

The platform name highlights which of the InEight solutions generated the CWA. Any CWA created in InEight Plan or Schedule will be available within Model.

13.2 STEP BY STEP 2 – CREATE A CONSTRUCTION WORK PACKAGE (CWP)

1. Select an existing CWP item, then Select **Add**.

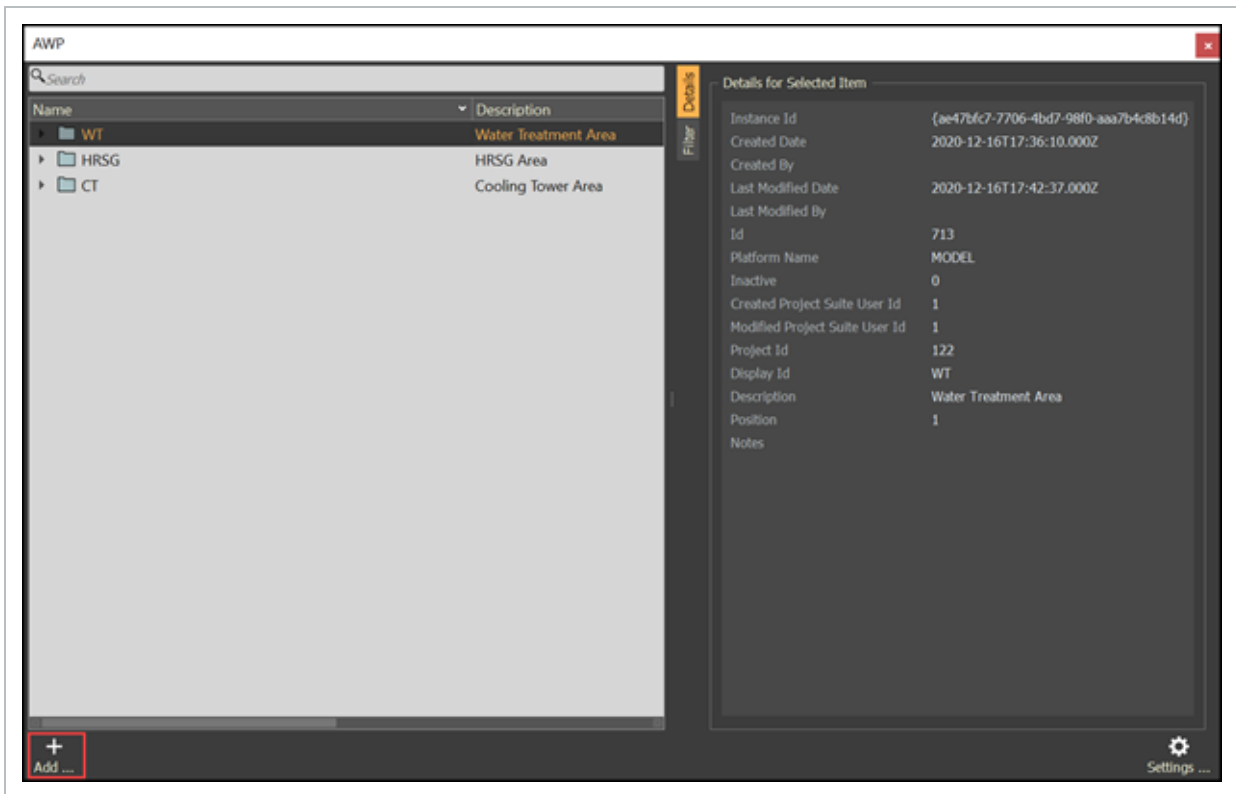

2. Click **Add AWP**.

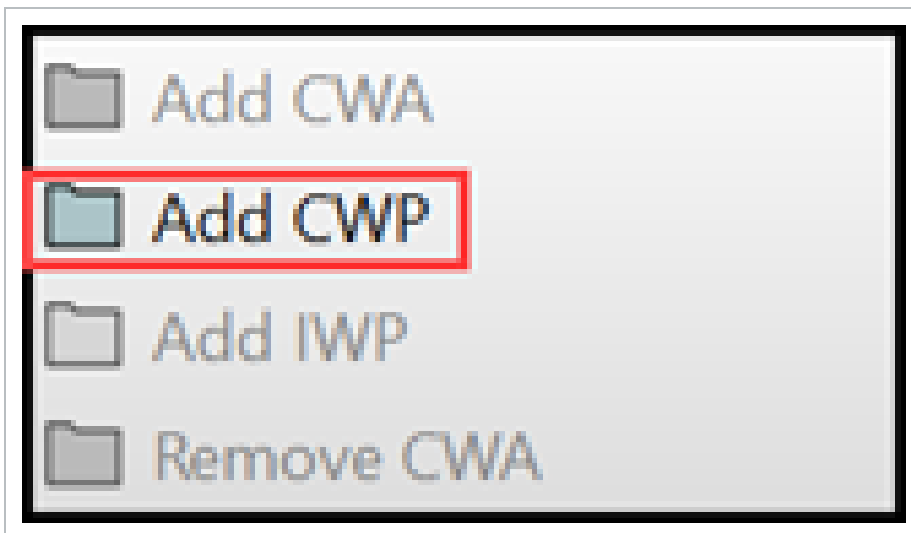

3. Fill out the CWP ID (project unique code or identifier).

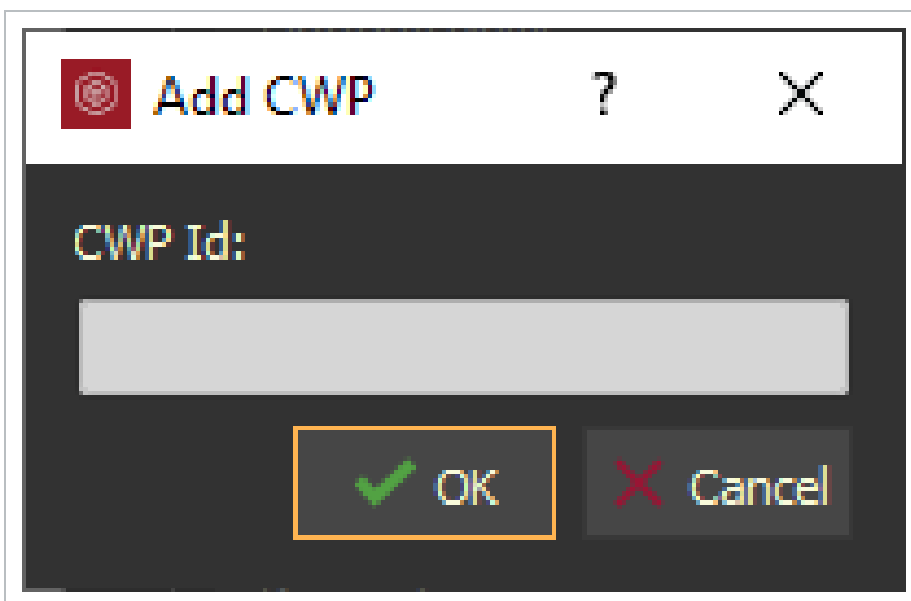

4. Click **OK**, then the new CWP will display within the AWP panel.

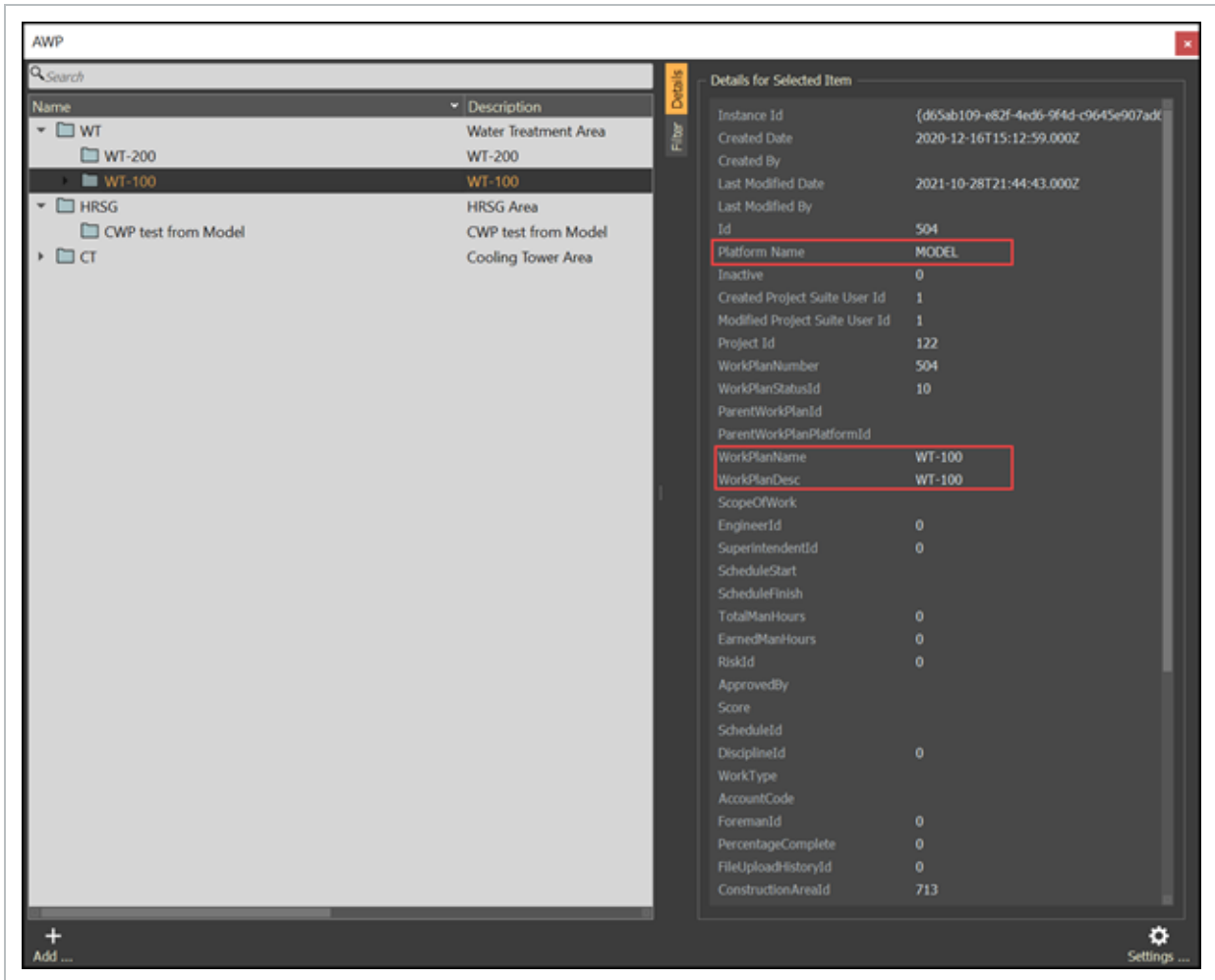

NOTE The platform name highlights which of the InEight solutions generated the CWP. Any CWP created in InEight Plan or Schedule will be available within Model. With the InEight platform, additional metadata associated with the CWP will be visible within the InEight Model. Connecting AWP structure with InEight Schedule allows for schedule metadata to be visible within the InEight Model. Connecting AWP with InEight Plan & Progress allows for work-hours, progress percent complete, and other metadata to be visible within the InEight Model.

13.2 STEP BY STEP 3 – CREATE A INSTALLATION WORK PACKAGE (IWP)

1. Select an existing CWP item, then Select **Add**.

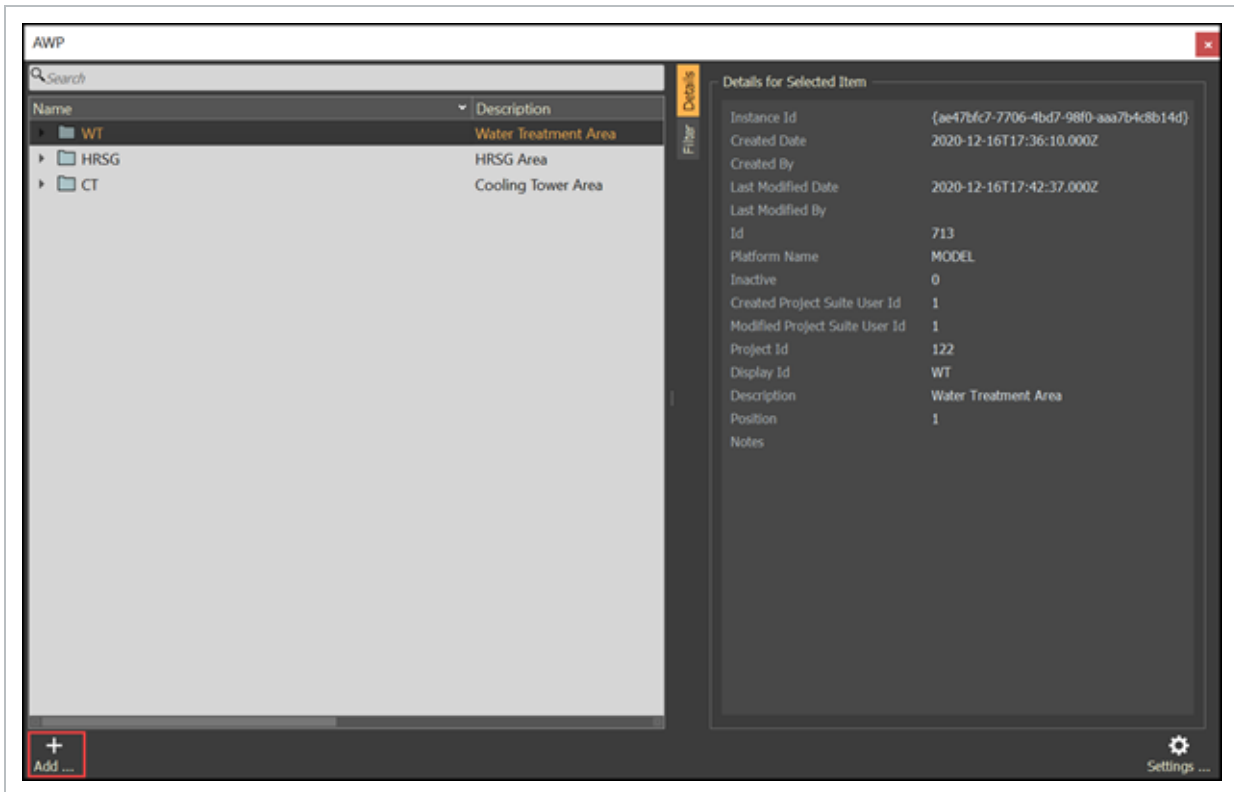

2. Click **Add IWP**.

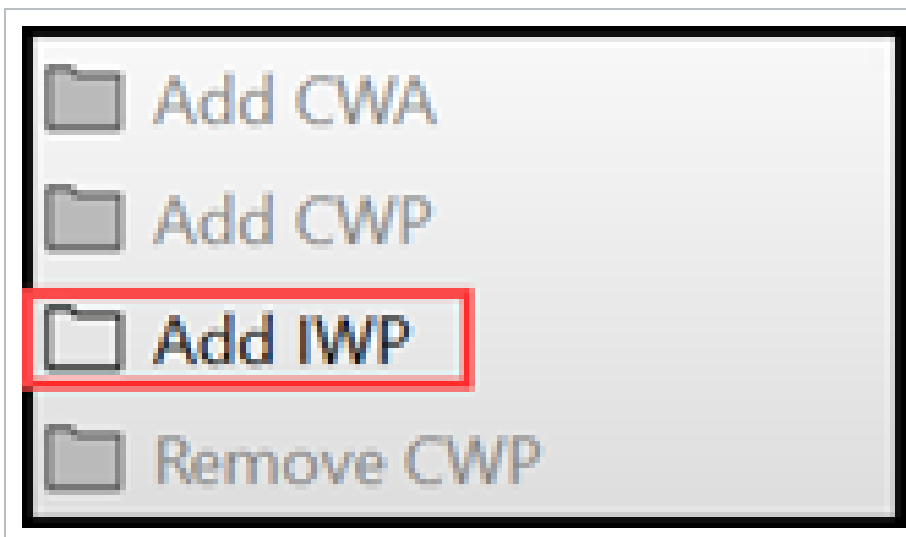

3. Fill out the IWP ID (project unique code or identifier).

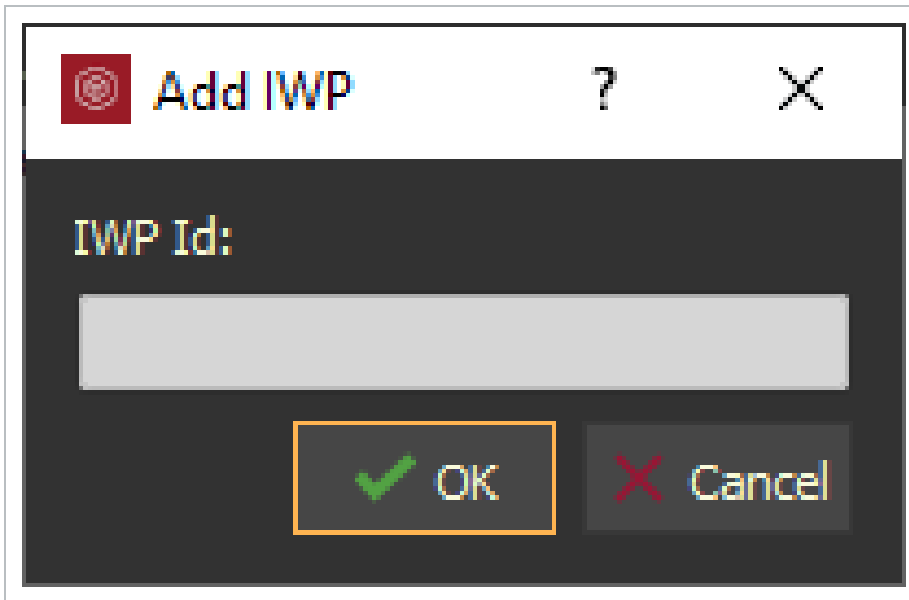

4. Click **OK**, then the new IWP will display within the AWP panel.

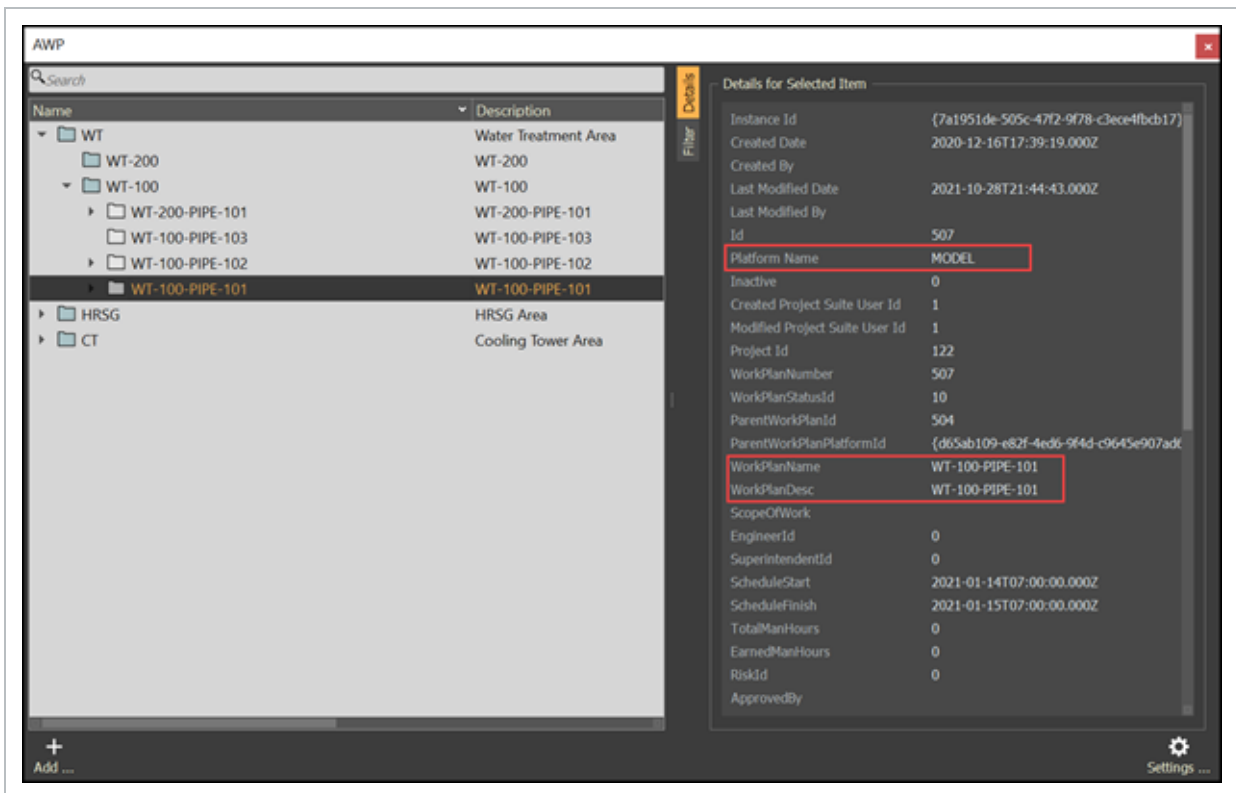

NOTE

The platform name highlights which of the InEight solutions generated the IWP. Any IWP created in InEight Plan or Schedule will be available within Model. With the InEight platform, additional metadata associated with the CWP will be visible within the InEight Model. Connecting AWP structure with InEight Schedule allows for schedule metadata to be visible within the InEight Model. Connecting AWP with InEight Plan & Progress allows for work-hours, progress percent complete, and other metadata to be visible within the InEight Model.

13.2 STEP BY STEP 4 – DELETING AWP STRUCTURE

1. Select one or multiple AWP structure items.

NOTE

Removing AWP structure items (CWA / CWP / IWP) must happen at the lowest level of the structure first. If an IWP has elements associated with it, these elements must be unlinked before deleting. The same logic applies to CWPs and CWAs.

2. Right mouse click on the AWP structure items, then select Remove IWP (or Remove CWP, or Remove CWA).

The screenshot displays the InEight Model software interface. On the left, a tree view shows the AWP structure. The selected item is 'WT-100-PIPE-103', which is highlighted in red. A context menu is open over this item, showing options: 'Add CWA', 'Add CWP', 'Add IWP', 'Remove IWP' (highlighted in red), 'Expand All', 'Collapse All', 'Expand Selected', and 'Collapse Selected'. The right pane shows the 'Details for Selected Item' for 'WT-100-PIPE-103'. The details include:

Property	Value
Instance Id	(5894b08c-a97f-420c-98e7-786651503de)
Created Date	2020-12-16T17:39:41.000Z
Created By	
Last Modified Date	2020-12-16T17:39:41.000Z
Last Modified By	
Id	508
Platform Name	MODEL
Inactive	0
Created Project Suite User Id	1
Modified Project Suite User Id	1
Project Id	122
WorkPlanNumber	508
WorkPlanStatusId	10
ParentWorkPlanId	504
ParentWorkPlanPlatformId	{d65ab109-e82f-4ed6-964d-c9645e907ad}
WorkPlanName	WT-100-PIPE-103
WorkPlanDesc	WT-100-PIPE-103
ScopeOfWork	
EngineerId	0
SuperintendentId	0
ScheduleStart	
ScheduleFinish	
TotalManHours	0
EarnedManHours	0
RiskId	0
ApprovedBy	

13.2 STEP BY STEP 5 – FILTER AWP STRUCTURE

Filter the AWP structure per predefined criteria

Select one or multiple AWP structure items.

1. Select the Filter tab, then set the criteria as desired.

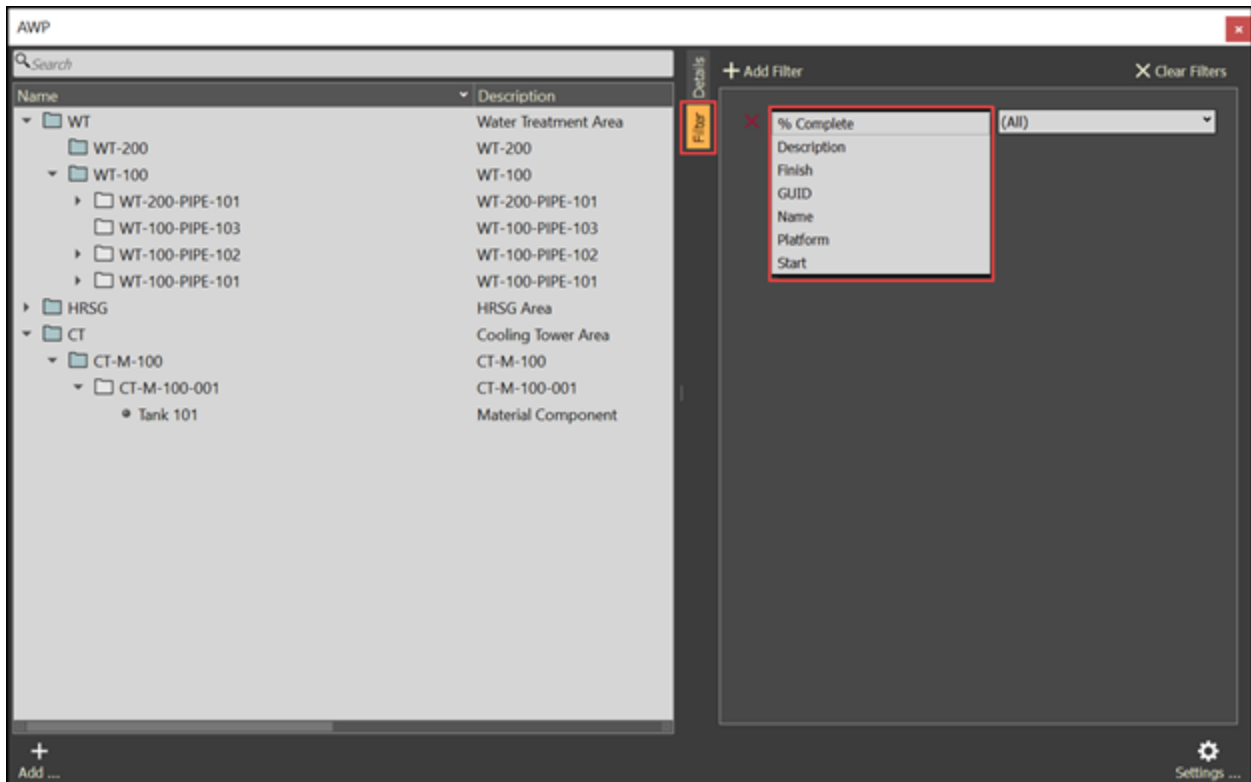

NOTE Additional filters can be added as desired.

13.3 QUANTITY CLAIMING

You can perform component claiming at the Construction Work Package (CWP) level and the Installation Work Package (IWP) level and sync changes with InEight Plan. You can mark claiming in full or enter a partial install quantity.

When selecting an IWP for claiming, you can claim for each step in the Claiming tab. The steps are listed across the claiming tab from left to right.

The following image shows claiming in the AWP panel:

The screenshot shows the InEight MODEL interface. On the left is a tree view of the project structure, with 'A2-IWP-201' selected. A 'Claiming' filter is applied to the view. On the right, a table displays the details for 'A2-IWP-201'.

Element ID	Step Name [1]	ep Percentage [Is Complete [1]	Install Date [1]	
1	A2-077P-0888-...	Transport to Site	15	<input checked="" type="checkbox"/>	4/30/2024 11:(
2	A2-077P-0888-...	Transport to Site	15	<input checked="" type="checkbox"/>	4/30/2024 11:(
3	A2-077P-0888-...	Transport to Site	15	<input type="checkbox"/>	
4	A2-077P-0888-...	Transport to Site	15	<input checked="" type="checkbox"/>	7/29/2022 12:(
5	A2-077P-0888-...	Transport to Site	15	<input type="checkbox"/>	
6	A2-077P-0891-...	Transport to Site	15	<input type="checkbox"/>	
7	A2-077P-0891-...	Transport to Site	15	<input type="checkbox"/>	
8	A2-077P-0866-...	Transport to Site	15	<input type="checkbox"/>	
9	A2-077P-0866-...	Transport to Site	15	<input type="checkbox"/>	
10	A2-077P-0866-...	Transport to Site	15	<input type="checkbox"/>	
11	A2-077P-0866-...	Transport to Site	15	<input checked="" type="checkbox"/>	7/29/2022 12:(
12	A2-077P-0950-...	Transport to Site	15	<input type="checkbox"/>	
13	A2-077P-0868-...	Transport to Site	15	<input type="checkbox"/>	
14	A2-077P-0868-...	Transport to Site	15	<input type="checkbox"/>	
15	A2-077P-0868-...	Transport to Site	15	<input type="checkbox"/>	
16	A2-077P-0868-...	Transport to Site	15	<input type="checkbox"/>	
17	A2-077P-0868-...	Transport to Site	15	<input type="checkbox"/>	
18	A2-077P-0868-...	Transport to Site	15	<input type="checkbox"/>	
19	A2-077P-0869-...	Transport to Site	15	<input type="checkbox"/>	
20	A2-077P-0869-...	Transport to Site	15	<input type="checkbox"/>	
21	A2-077P-0869-...	Transport to Site	15	<input checked="" type="checkbox"/>	7/29/2022 12:(
22	A2-077P-0869-...	Transport to Site	15	<input type="checkbox"/>	
23	A2-077P-0980-...	Transport to Site	15	<input type="checkbox"/>	
24	A2-077P-0983-...	Transport to Site	15	<input type="checkbox"/>	

13.3.1 STEPS

- **Is Complete** – Mark the item's checkbox to do a complete claiming.
- **Install Quantity** – Click in the Install Quantity field, and then enter the partial quantity you want to claim.

- **Save Changes** – Click File > **Save Project** to save your changes and sync with Plan. When you select Save Project, a Save Changes dialog box shows with the pending updates. Click **Save** to sync the changes with Plan.
- **Project updates** – When the sync to Plan is complete, a You have project updates banner shows at the bottom left of the panel. The Project updates icon’s color at the bottom of the panel also turns to green. You must click the Project updates icon, and then select **Update Now** to update Model.

13.3.2 CONSIDERATIONS

Reverse claiming must be done in the Plan application. After you reverse claiming quantities in Plan, changes will sync in Model.

CHAPTER 13 – SCHEDULE

13.1 INEIGHT VISUAL REPORT

The InEight Visual Report tab shows all the visual reporting data from the existing InEight tab and includes additional functions that you can use to build visual reporting data.

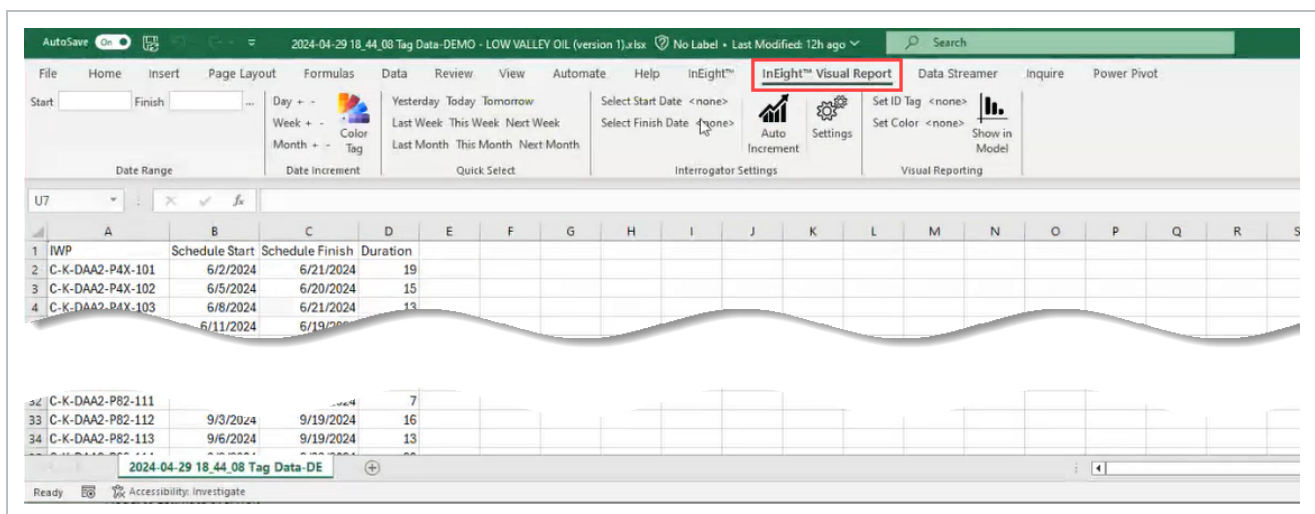

After you set the ID tag, you can use the following tools to customize the inspector:

- Add schedule start and finish dates.

- Use Settings to open the Interrogator Settings to set scheduled functions that includes define colors, enable Show Complete, change date settings, configure auto increment settings.

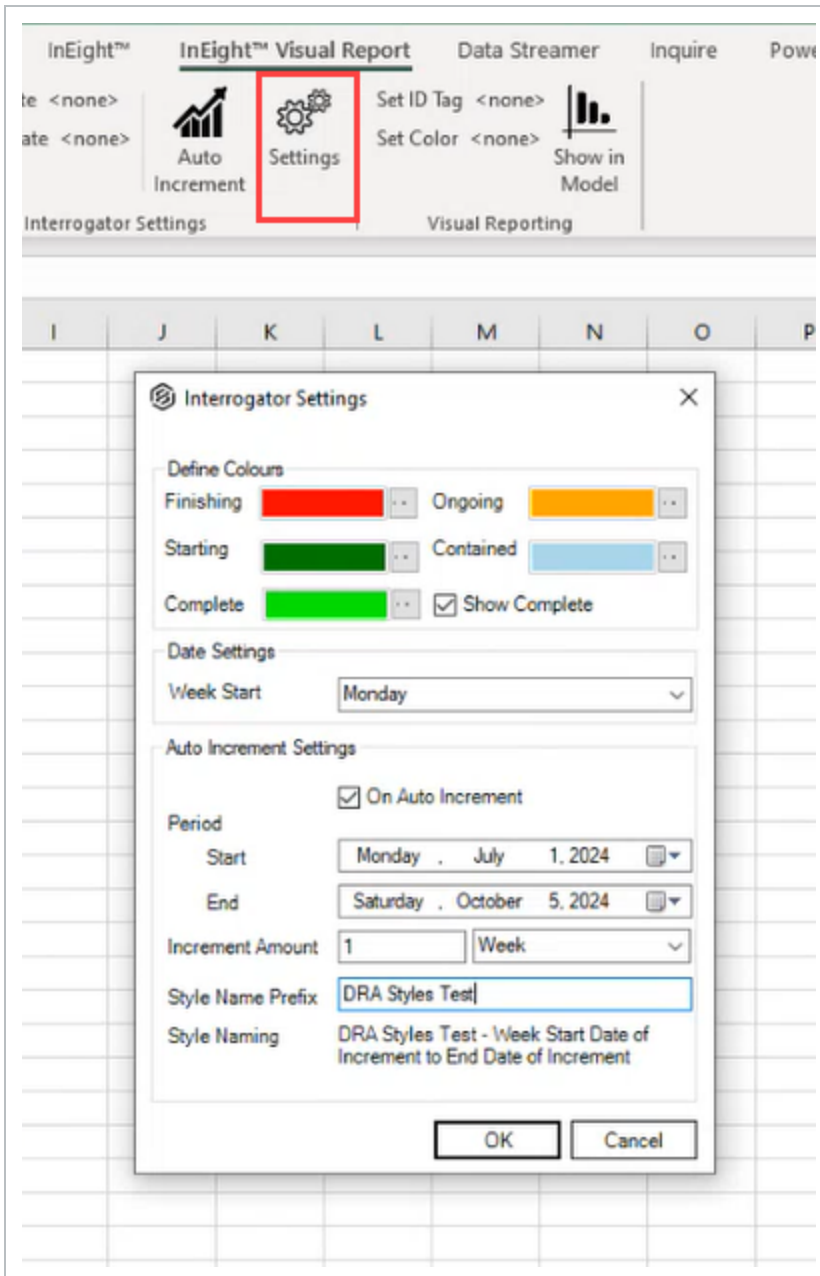

- Configure the increments in days, weeks, or months to view date ranges and track scheduled items.

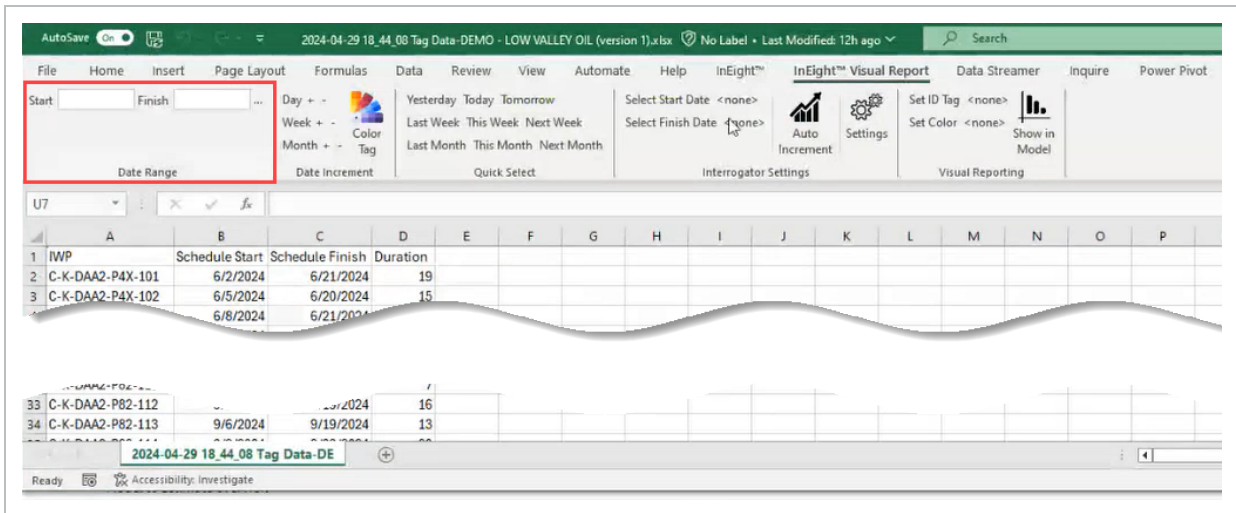

- You can view your IWP selection in Model by clicking the **Show in Model** button.

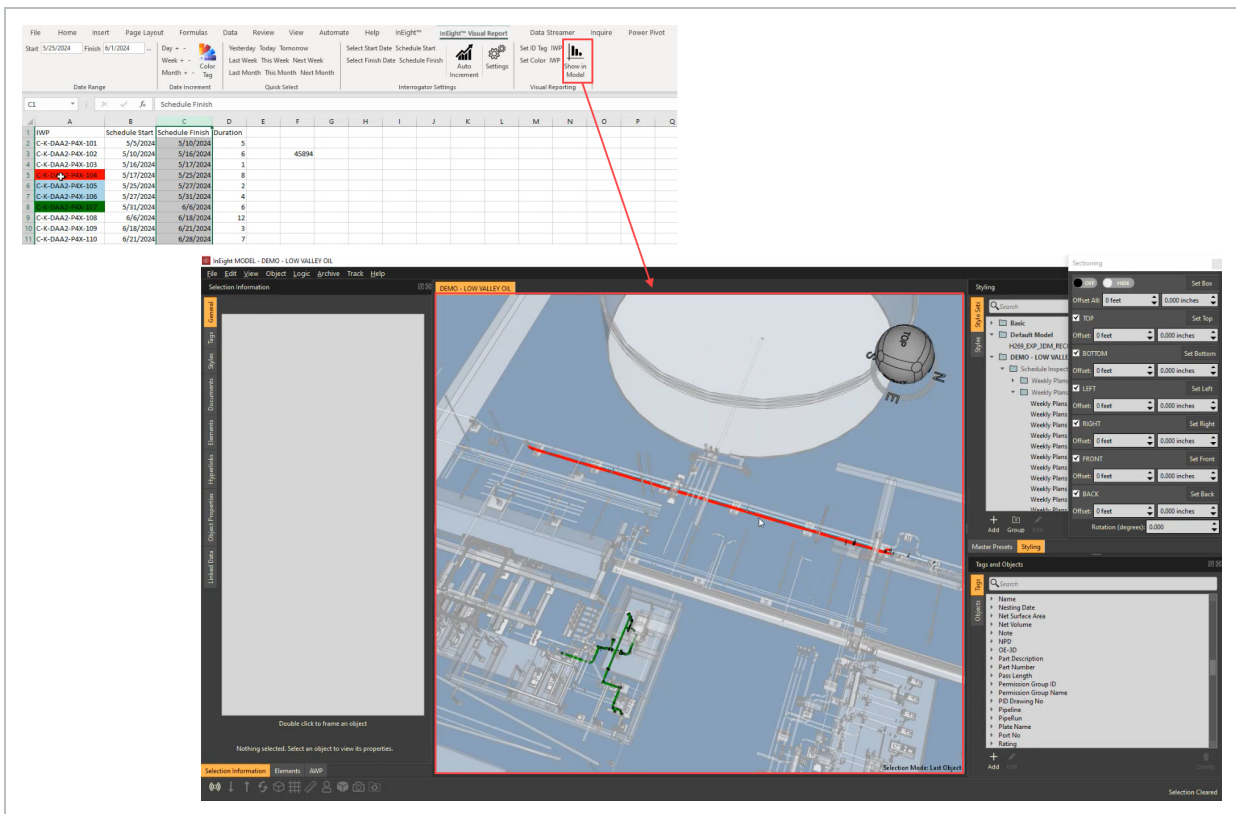

- When On Auto Increment is selected in settings, and you click the **Auto Increment** button, a style set is created for every increment amount selected. You can select each style set scheduled

increment and view in the model.

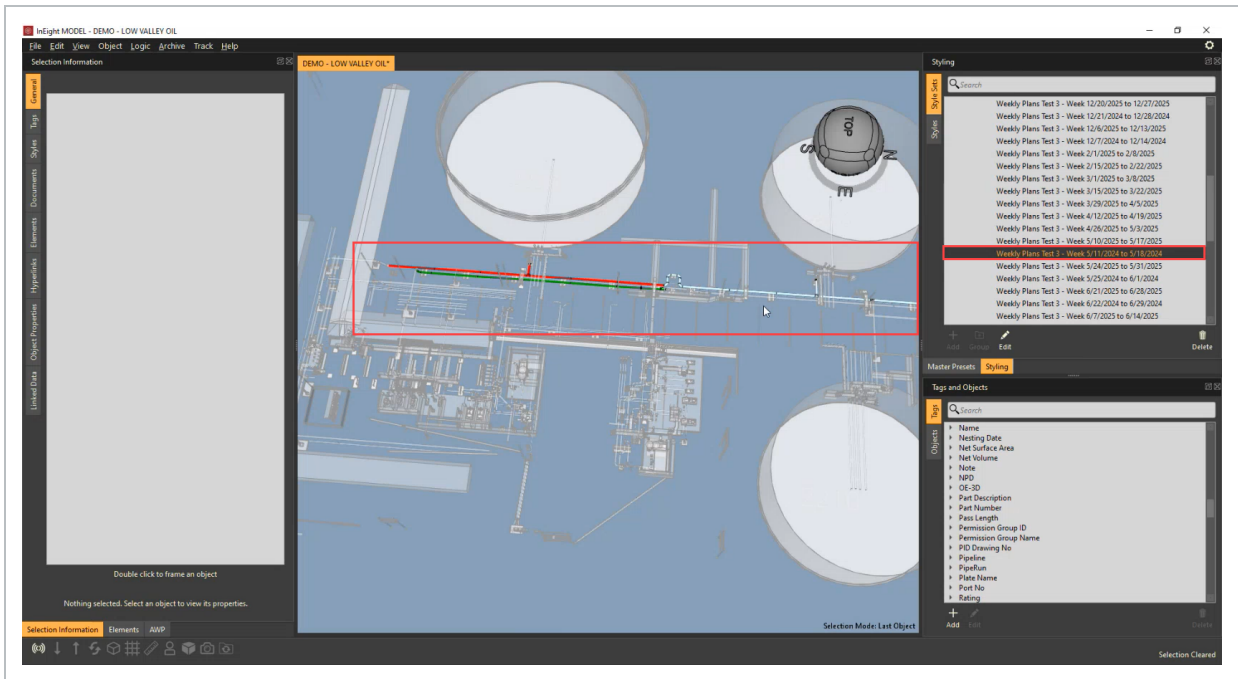

CHAPTER 14 – MODEL MOBILE

14.1 INTRODUCTION

You can support the entire project lifecycle at the office or the worksite with the InEight Model mobile application. In Model mobile, you have access to your model and model data to view and interact using an iOS mobile device. The Model mobile application is available to download from the Apple App Store.

14.2 OVERVIEW

When you open the application, a log in window shows:

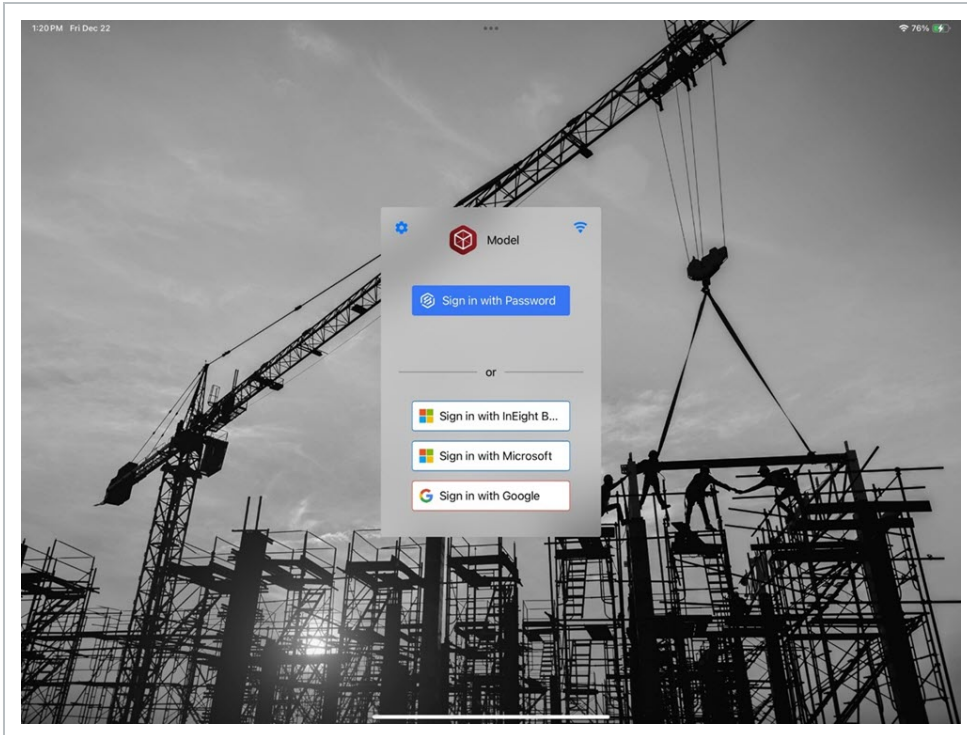

After you log in, a list of the projects you have permissions to is shown:



From the list of projects, tap a project to open it. The project opens to the Model viewer module, which is the default landing module. You can switch modules by selecting the **Main** menu, and then selecting from the list of available project modules such as Model, Elements, Issues, and Archive Library.

Model geometry will begin to load when an internet connection is active.

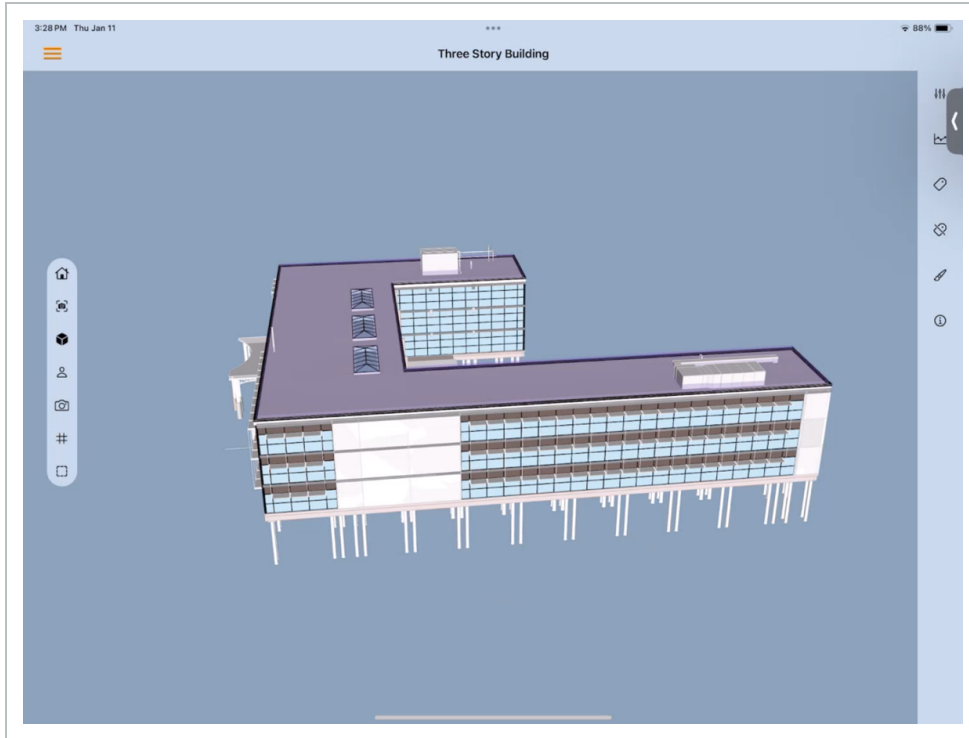

Some features are not fully functional until the entire tag library is downloaded to your device. A warning banner shows at the top of the screen to communicate this state.

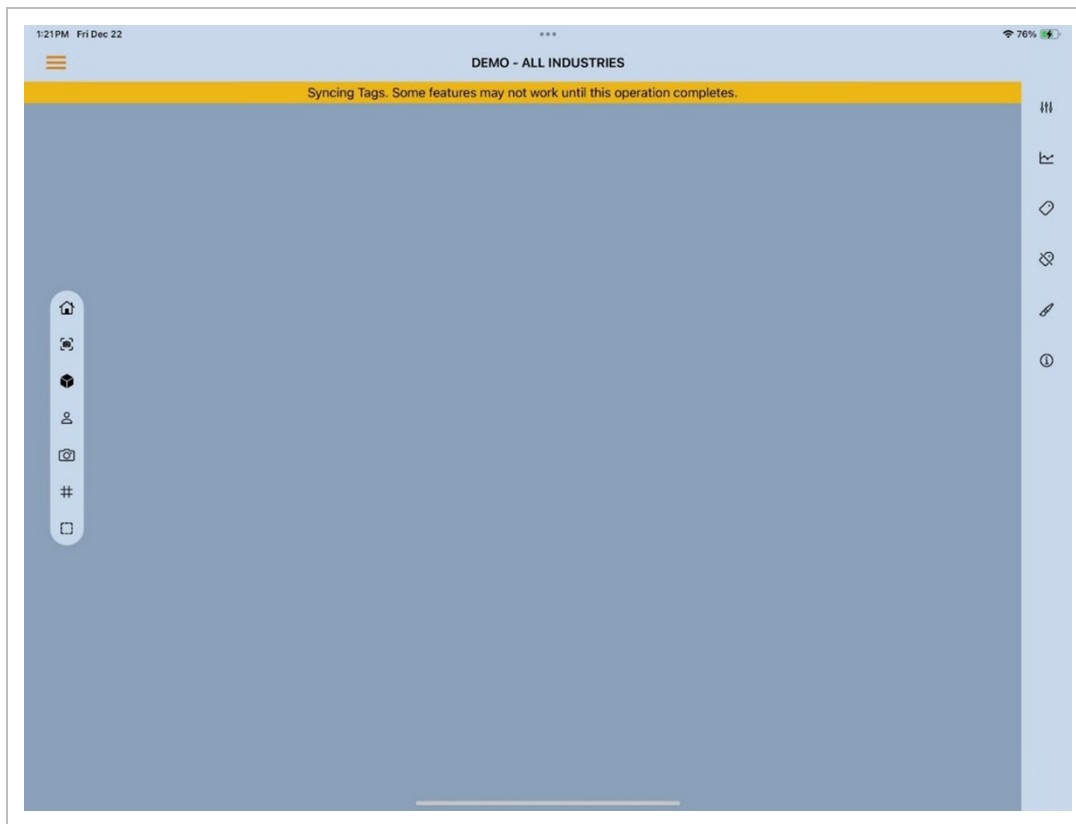

Features of Model mobile include the following:

- **Navigation** - Typical iOS gestures. [Read more](#)
You can navigate in Model mobile using typical iOS one and two finger gestures such as tap, scroll, select, orbit, pan, pinch open and pinch closed objects or models.
- **Offline Data** - You can download model data to your local device and use Model offline where internet access is not available. [Read more](#)
Select the main menu > Offline Data > **Master Presets** to specify which data is downloaded for offline mode.

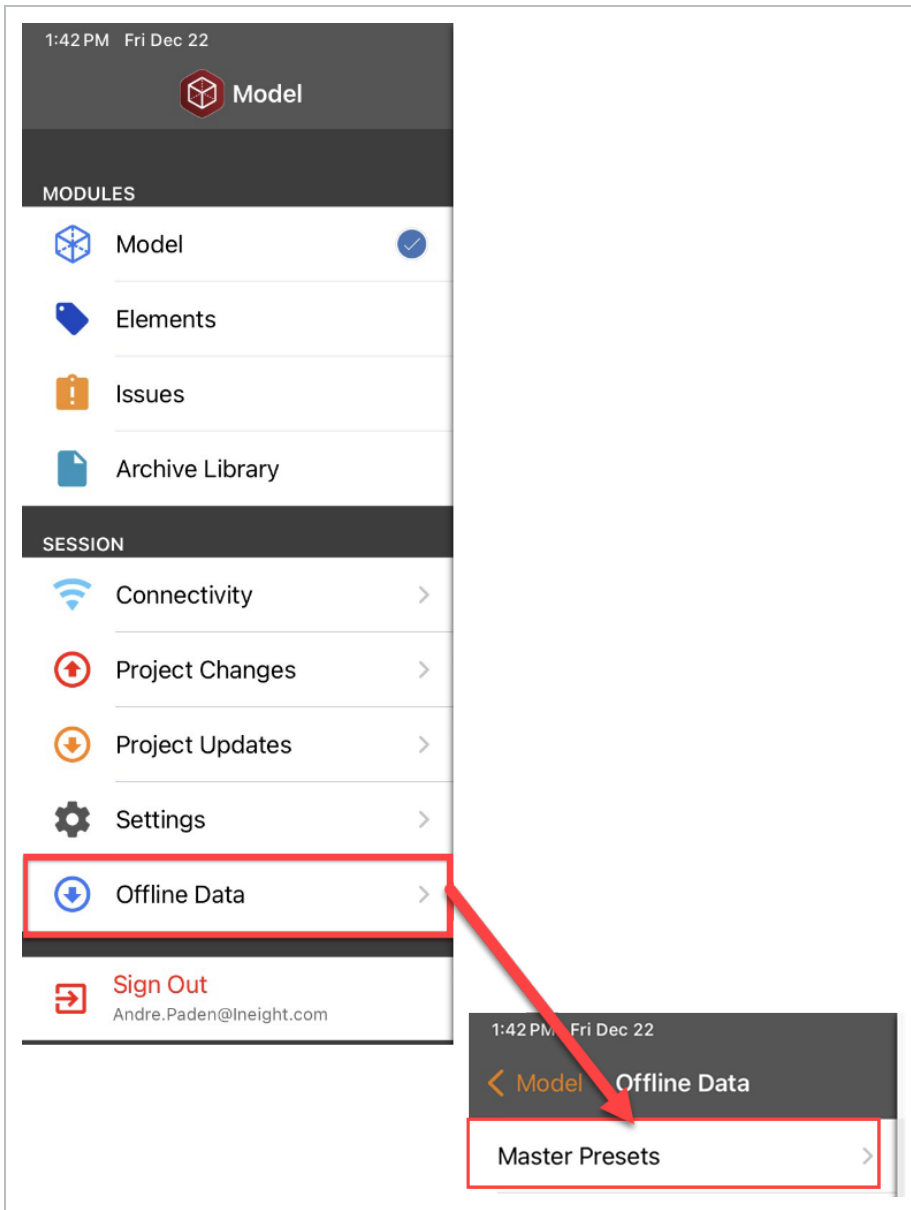

After you select Offline Data, you can choose which data to download in using the Master Presets. You can choose individual master presets or collections of presets for offline mode. Download status is shown next to the master preset.

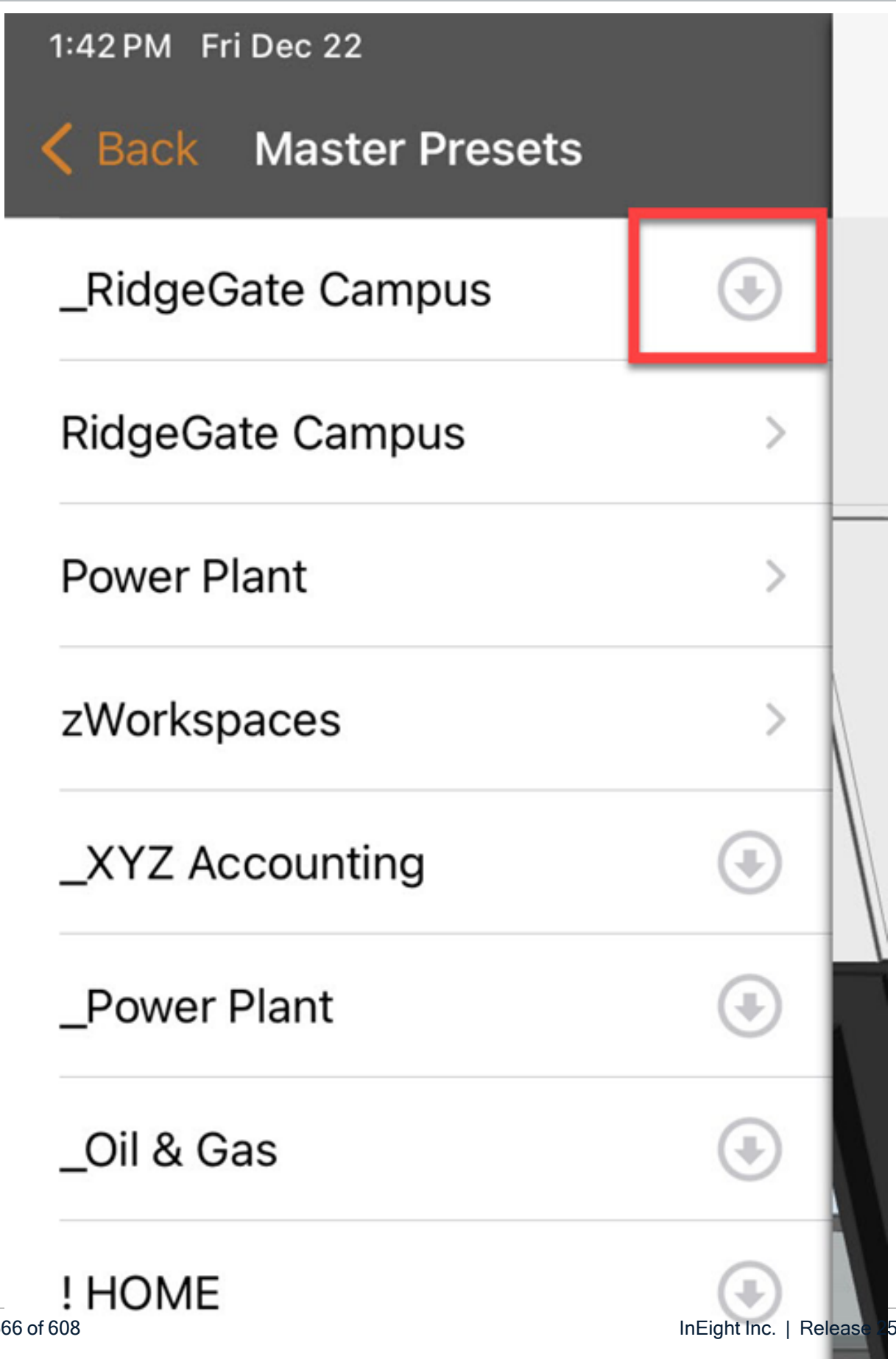

- **Left ribbon menu** - Standard Model functions. [Read more](#)

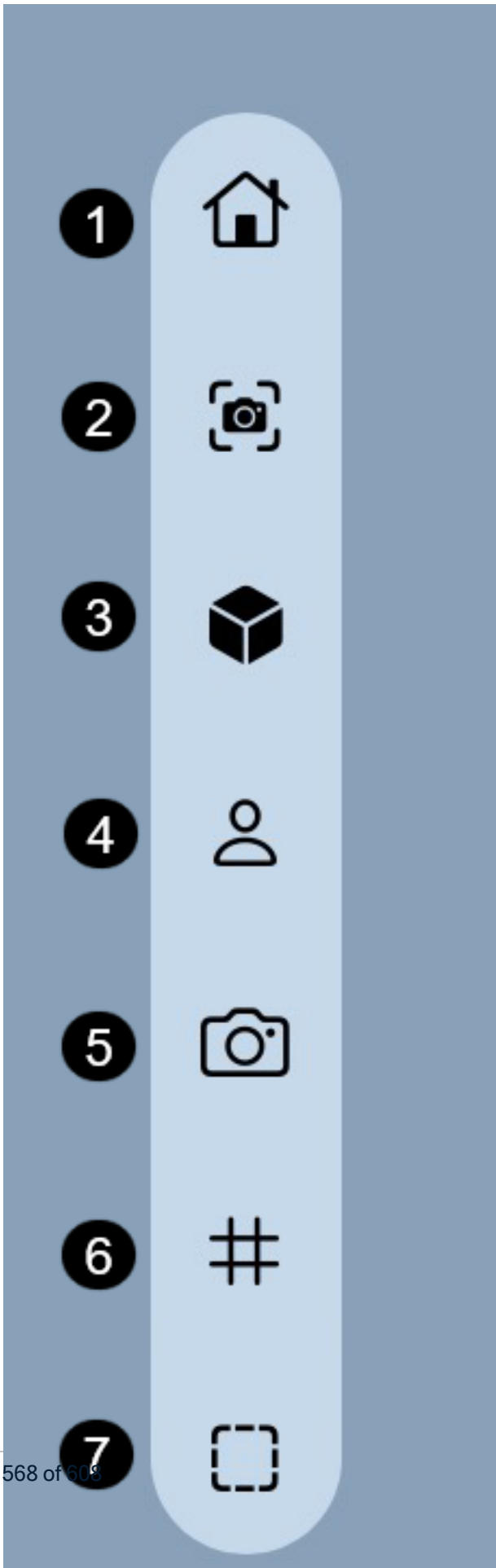

1. **Home** – Applies the default project master preset.
2. **Zoom Selected** – Zooms the camera to frame the selection.
3. **Isolate** – Toggles between the entire model and an isolated view of the selected objects.
4. **First-Person Navigation** – Toggles first-person navigation.
5. **Ortho/Perspective** - Toggles between orthographical and perspective camera.
6. **Grids** – Toggles grid visibility on/off.
7. **Selection Mode** – Provides the ability to select objects related to the active mode.

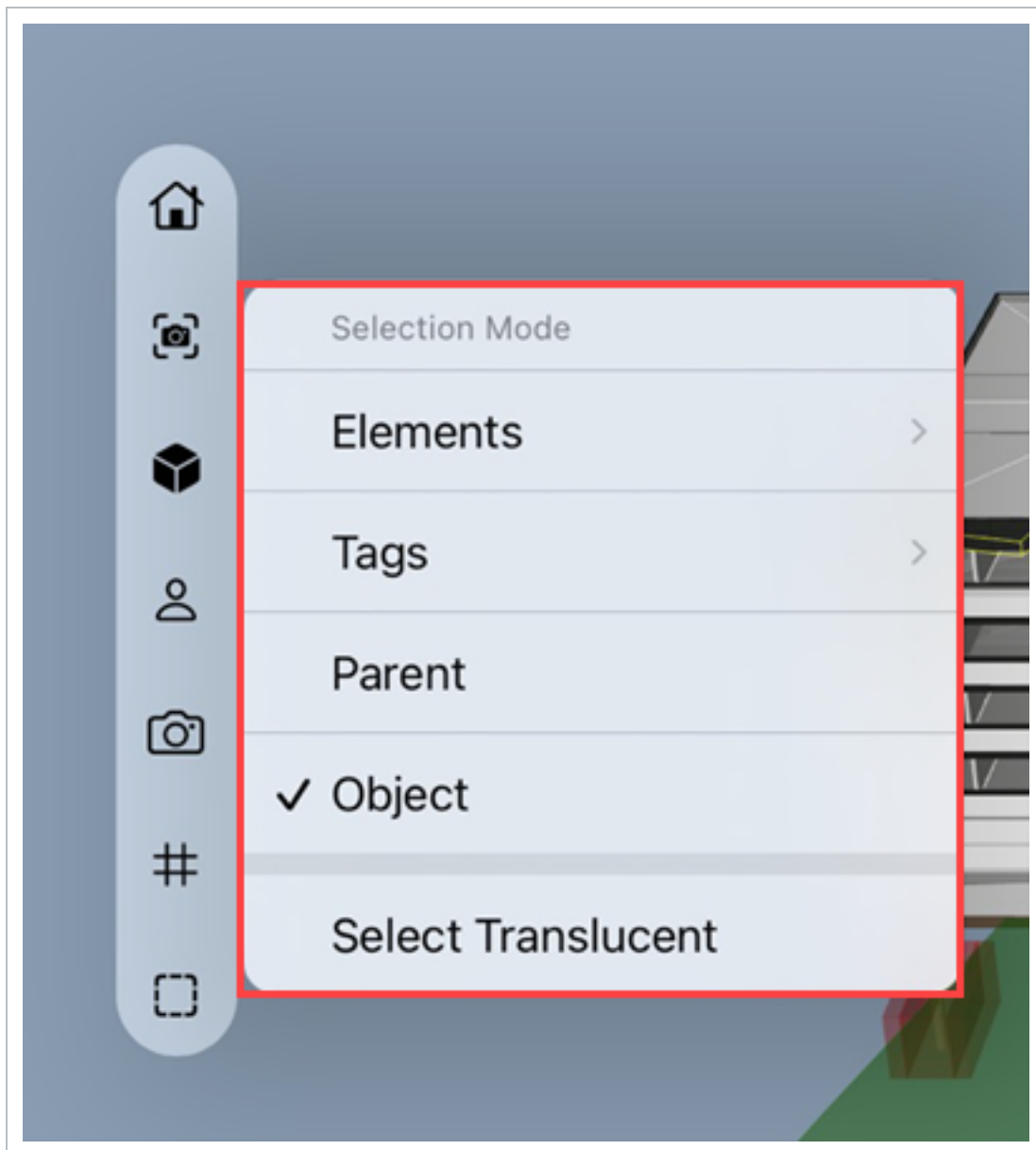

- **Elements** - Select objects that belong to the Element associated with the object being selected.
- **Tags** - Select objects that belong to the tag associated with the object being selected.
- **Parent** - Selects all objects belonging to the highest level.
- **Object** - Select the lowest level of an object.
- **Right navigation menu** - Find familiar model panels in the right vertical menu. [Read more](#)





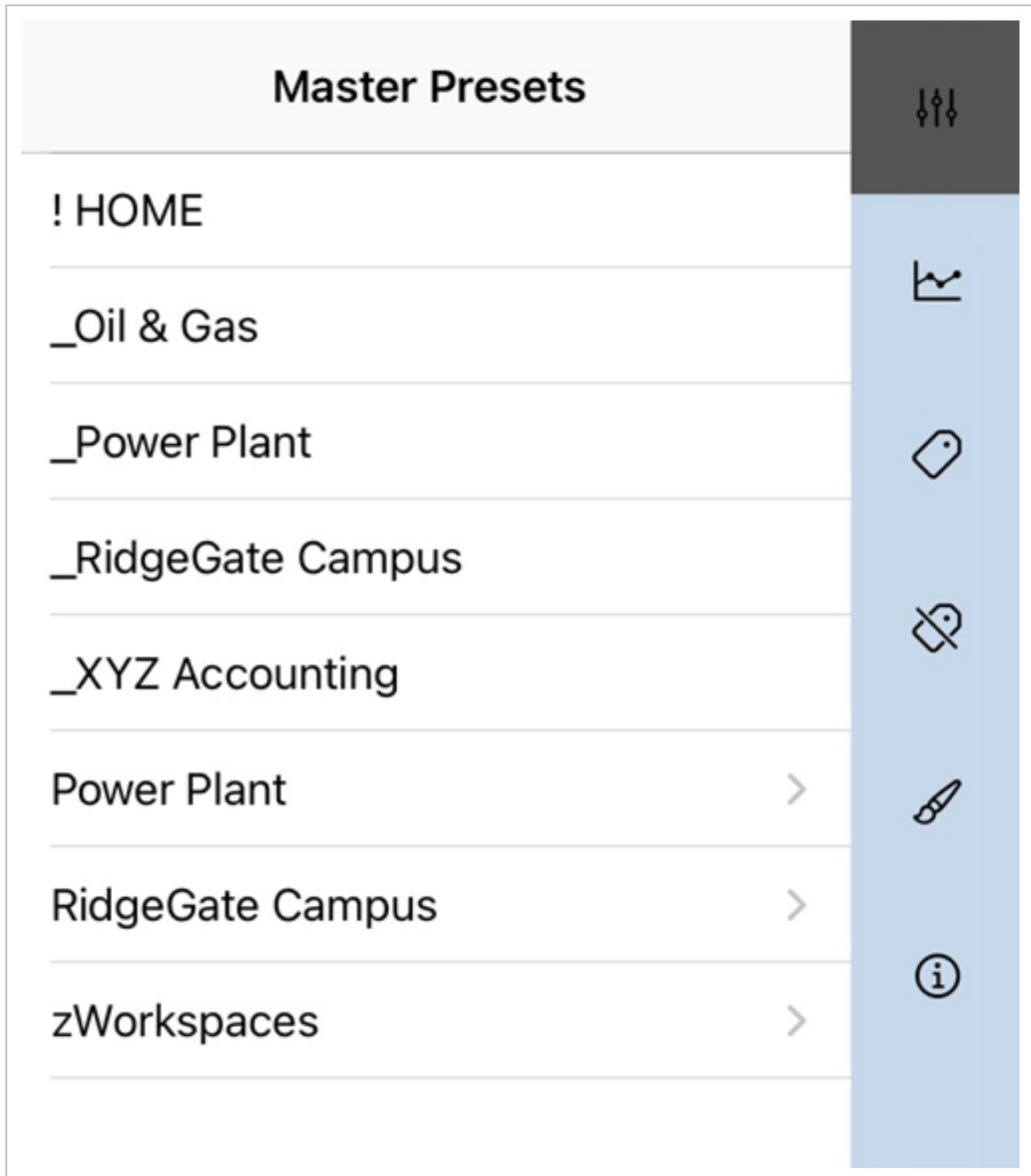

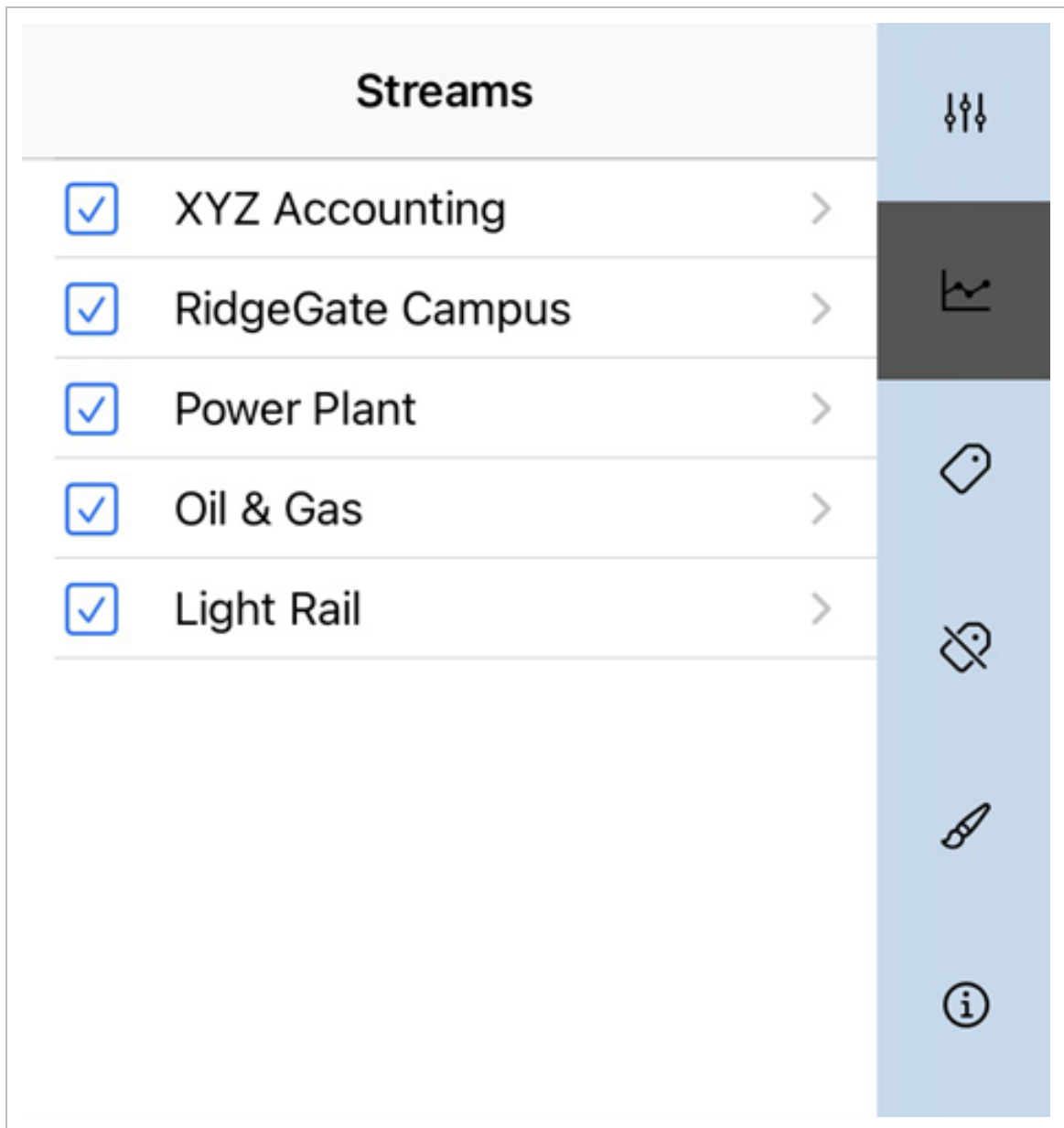

1. **Master Presets** – Navigate between master presets defined in Model desktop.



2. **Model Streams** – Turn visibility on or off for model streams and groups.



3. **Tags** - You can navigate tag names and values and select associated model objects.

Tags	
00-CWA_PowerPlant >	
30_EstimatingTags_RidgeGate >	
70 - Activities - PowerPlant >	
70 - Activities - RidgeGate >	
CBS >	
Description >	
Material Name - CAD >	
Model_Stream >	
Name >	
Pipeline >	
PipeRun >	
Revit_Family_Type >	
Revit_Function >	
Spool >	
Tag_Level >	
Tag_PhysicalType >	



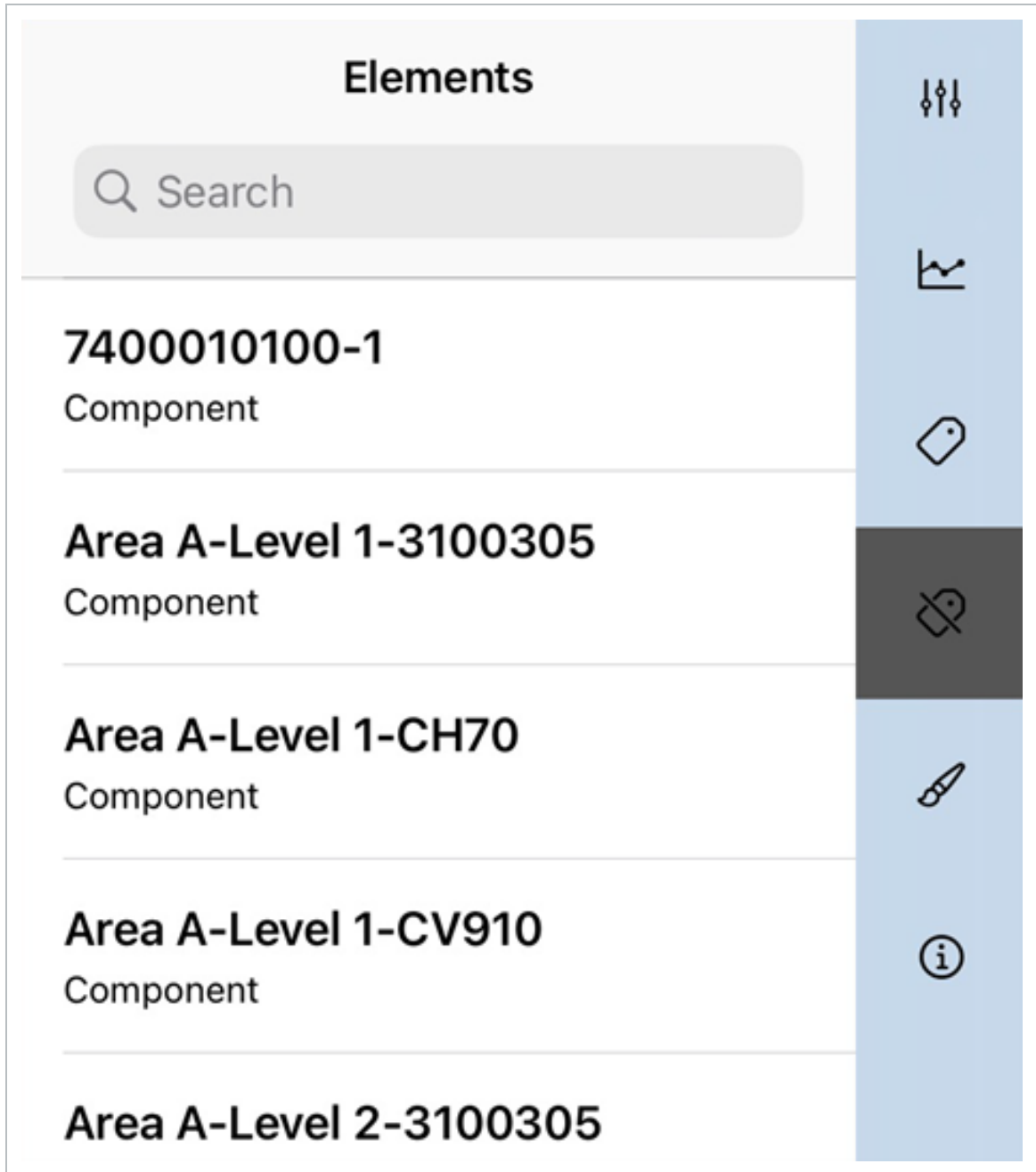

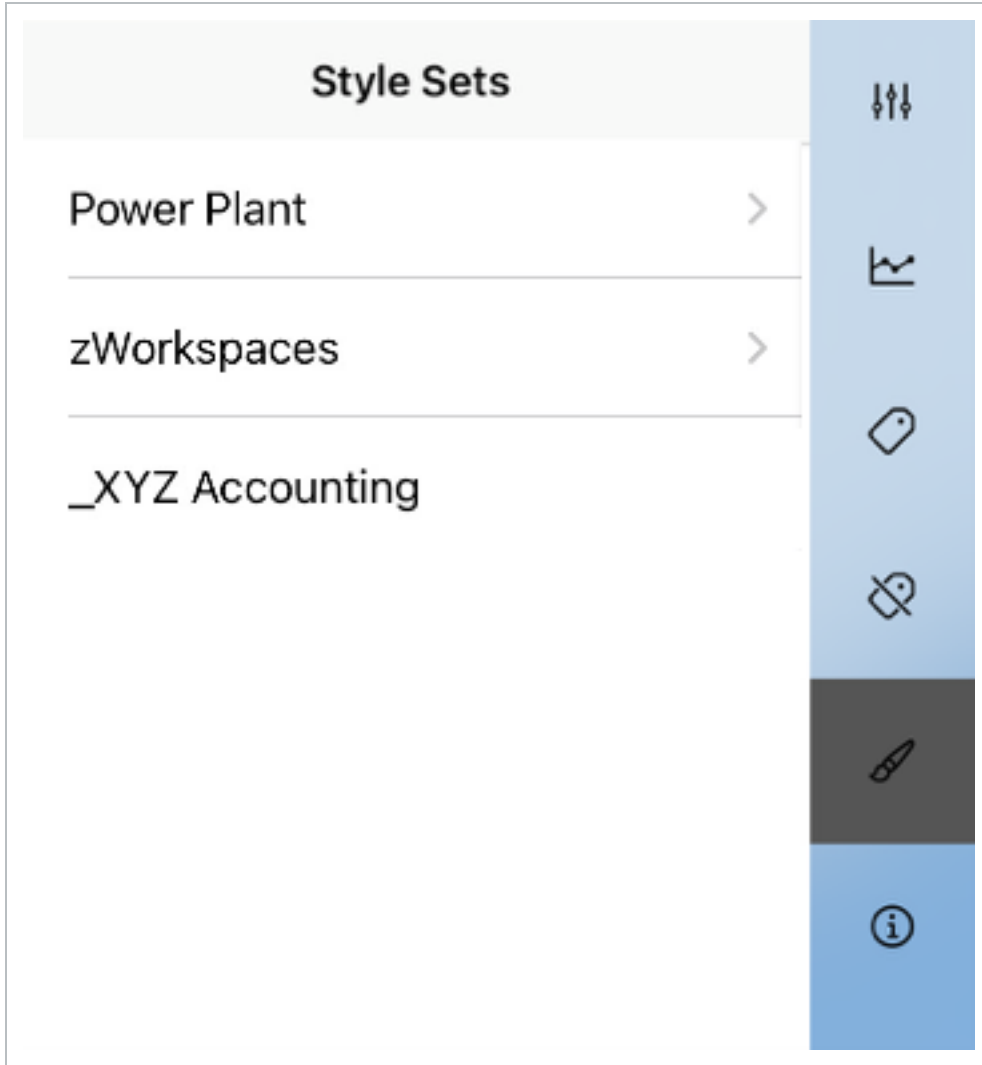

4. **Elements** - Navigate elements and select associated model objects.



5. **Style sets** - Switch style sets to change how they visualize the model.



- 6. **Selection Info** - Show attribute data of actively selected model objects in the Properties, Tags, and Related tabs.

Object Properties		
Constraints		
Level	CRAWL SPACE	
dp_Socket Length	31.0	
dp_Diameter	3.0	
Dimensions		
Length	0.0	
Width	0.0	
Identity Data		
Workset	Workset1	
Name	P3 (36")	
Cost	0	
Design Option	NotApplicable	
Image	NotApplicable	
IFC Parameters		
Type IfcGUID	0w9qc0Et9C0RLZAe1eAZmL	
IfcGUID	0I_pkhZ6b5reTP8\$VB7wHe	
Export Type to IFC	Default	
Export to IFC	By Type	

- **Object Properties** – Show the model object properties such as Constraints, Construction, and Dimensions.

Object Properties	
Constraints	
Level	CRAWL SPACE
dp_Socket Length	31.0
dp_Diameter	3.0
Dimensions	
Length	0.0
Width	0.0
Identity Data	
Workset	Workset1
Name	P3 (36")
Cost	0
Design Option	NotApplicable
Image	NotApplicable
IFC Parameters	
Type IfcGUID	0w9qc0Et9C0RLZAe1eAZmL
IfcGUID	0l_pkhZ6b5reTP8\$VB7wHe
Export Type to IFC	Default
Export to IFC	By Type

- **Tags** – Show any tags associated with the model object.

Tags	
Tags	
02 - Construction Levels	O1-Foundations
10 - Construction Status_RG_FNDs	06-Poured Concrete
30_EstimatingTags_RidgeGate	O1-Foundation Pier
70 - Activities - RidgeGate	O1-Foundation Pier_120
CBS	1.1.1.1
Default Style {ffa90a38-4341-463d-9e...}	#ffa8a8a8
Material Name - CAD	Concrete - Cast-in-Place Concrete
Model_Group	Office_1
Model_Stream	STRUCT_OFFICE_1
Revit_Family_Type	Structural Foundations : Drilled_Pier_KLAA_17SE : P3 (36")
Tag_Level	CRAWL SPACE
Tag_PhysicalType	Foundation

- **Related** – Show any related information associated with the model object such as associated elements, issues, checklists, and documents.

Related

Elements

O1-Foundation Pier_120 >
Component

14.2.1 CONSIDERATIONS

You only see projects that you have permission to access.

CHAPTER 14 – TAGS AND OBJECTS

14.1 TAGS AND OBJECTS OVERVIEW

Tags are the organizational structure of model objects and define a set of identifiers (category and value). You can interact with tags to manipulate your model in a variety of ways. For more information about tags, see [Tags and Objects Overview](#) in Model desktop.

14.2 MANAGE TAGS

You can add new tag names, add tag values, update, and remove tag value associations.

14.2.1 STEPS

ADD NEW TAGS

1. In the ribbon menu on the right, tap the **Tags** icon to open the Tags list, and then tap the **Add** icon.

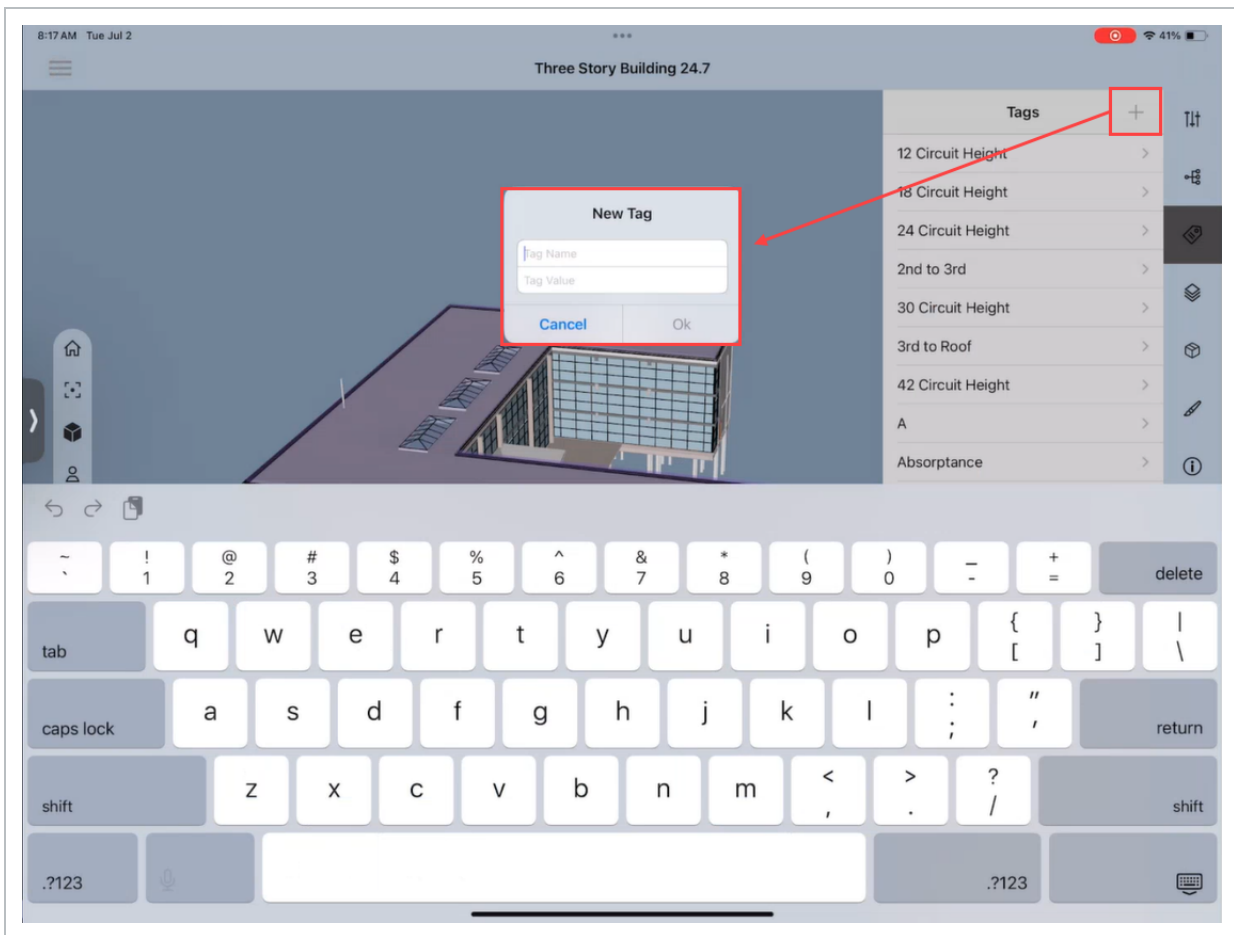

2. Enter the new tag information, and then tap **Ok**.

ADD AND UPDATE TAG VALUES

1. In the **Tags** list, swipe right on a tag, and then tap **Select**.
 - a. To update a tag, choose a tag value from the list, and then update the value.

- b. To add a tag value, tap the **Add tag** value icon, and then enter a new tag value.

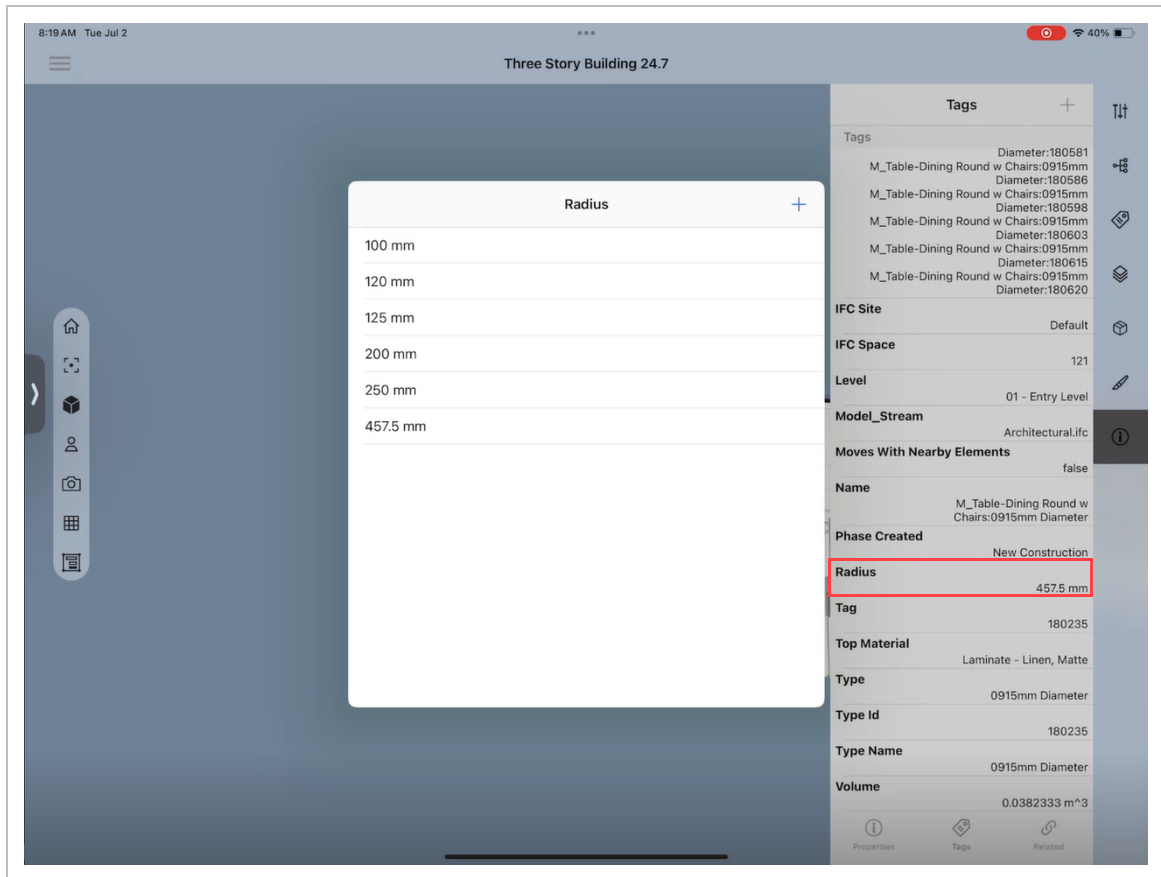

REMOVE TAG VALUES

In the **Tags** list, swipe left on a tag, and then tap **Remove**.

14.3 STYLES

14.4 STYLE SETS

There are predefined style sets in Element Progress and Work Package Progress (AWP) when a project is created, and the AWP is enabled. The default style sets are enabled in the Styling panel for Element Progress and Work Package Progress Style Sets.

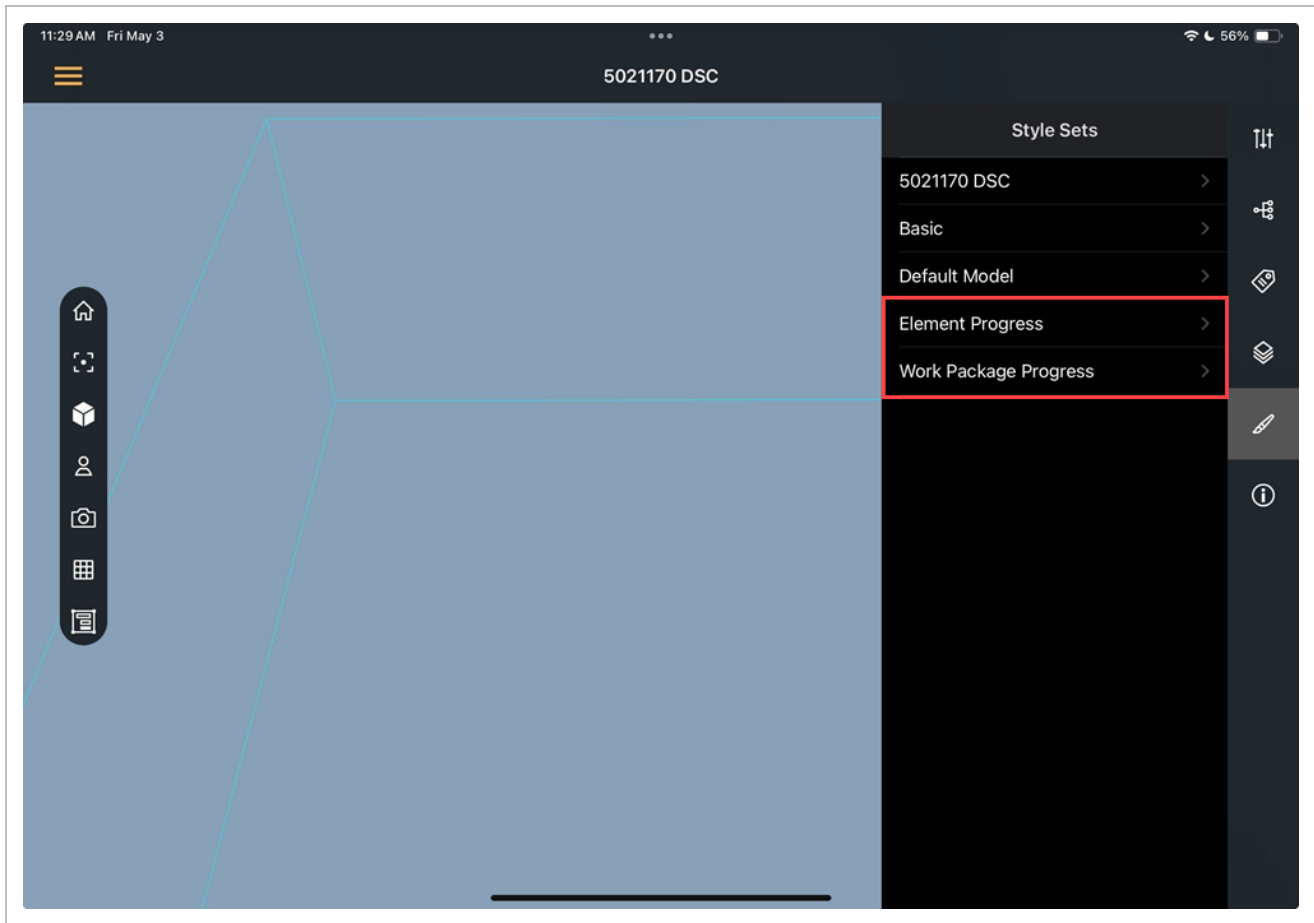

Style sets created in Model desktop sync to Model mobile and can represent real-world material characters such as glass and steel, or simple colors, to represent different disciplines or systems.

You can access Style sets by tapping the **Style sets** icon in the right navigation menu.

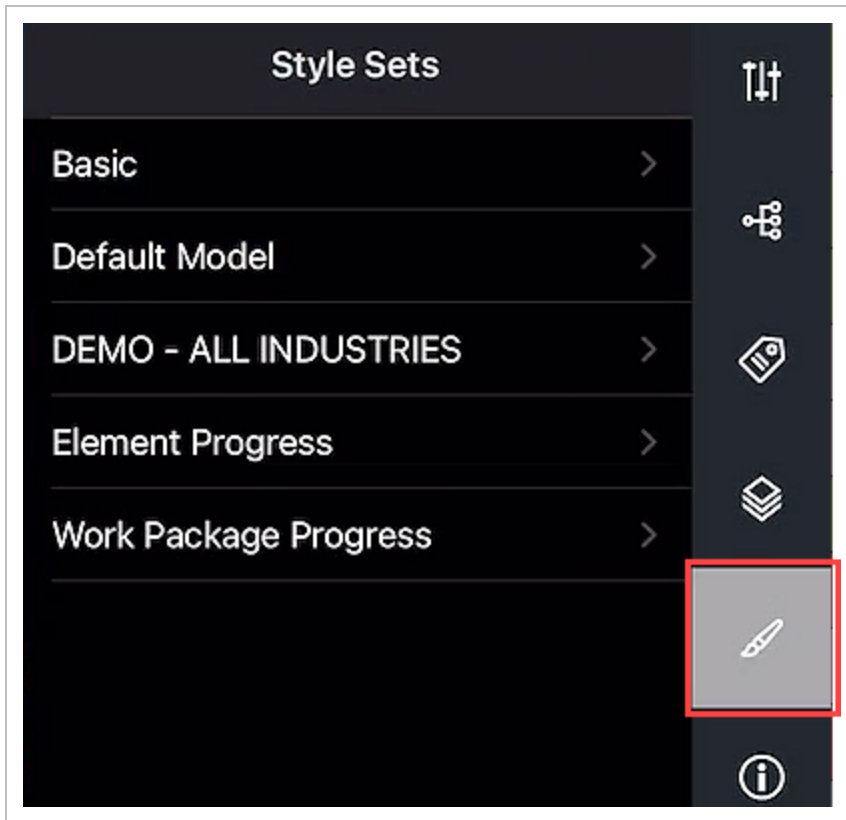

The following image shows the Element Progress style set:

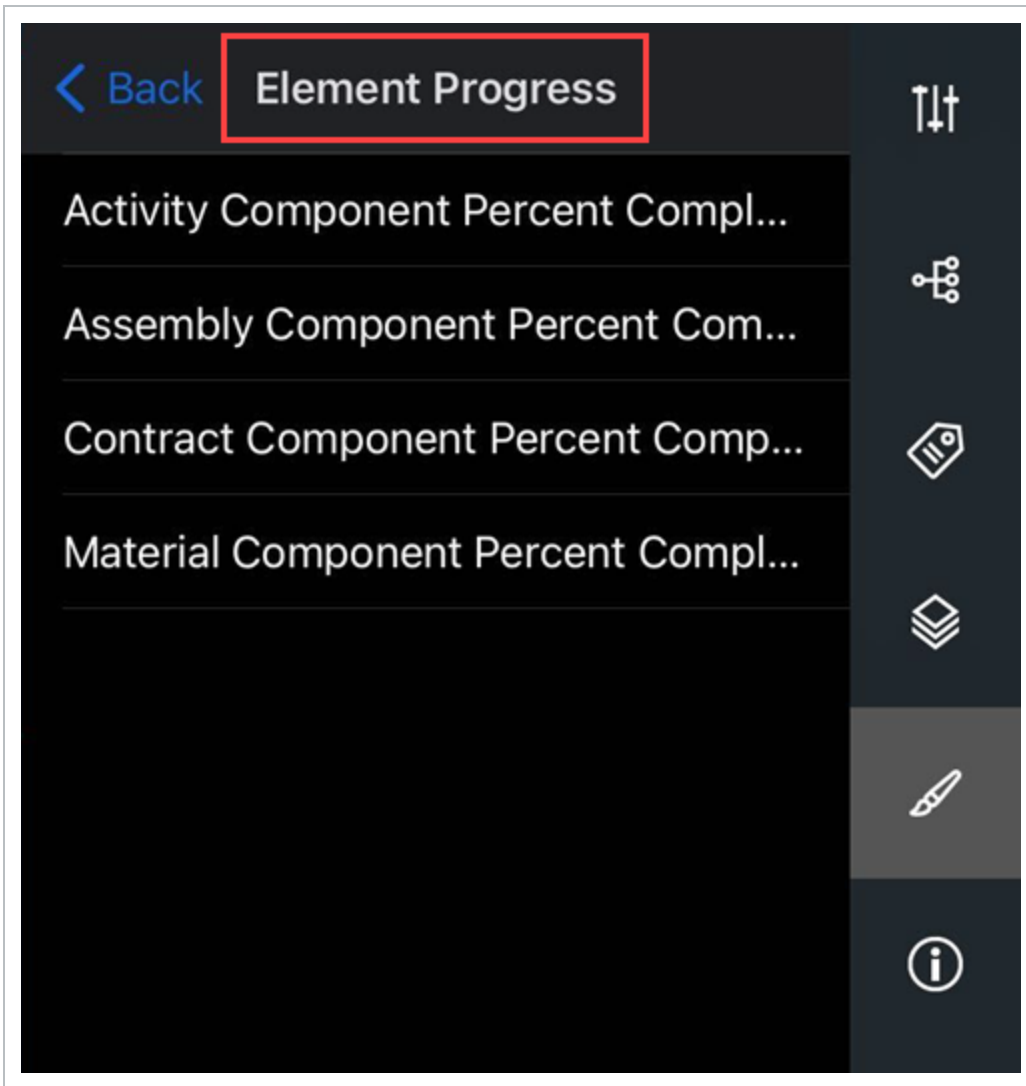

The following image shows the Work Package Progress style set:

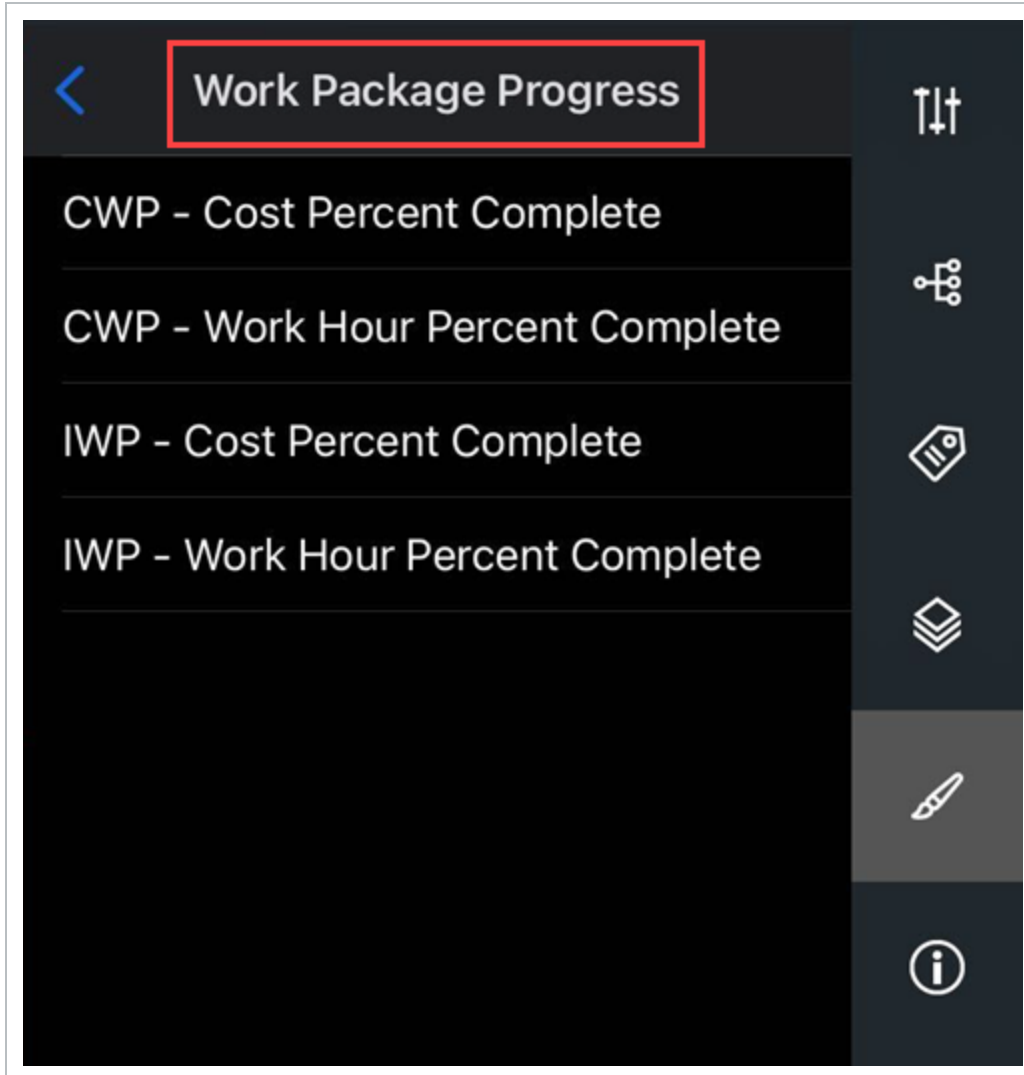

The default styles are read-only and have predefined progress indicators that cannot be edited.

CHAPTER 14 – MEASUREMENTS

14.1 MEASUREMENTS

In Measurements, you can enter measurement values to view your model in 3D and then save the values in a folder for reference and to use later. To access the Measurements panel, select the **Measurements** icon on the right vertical menu.

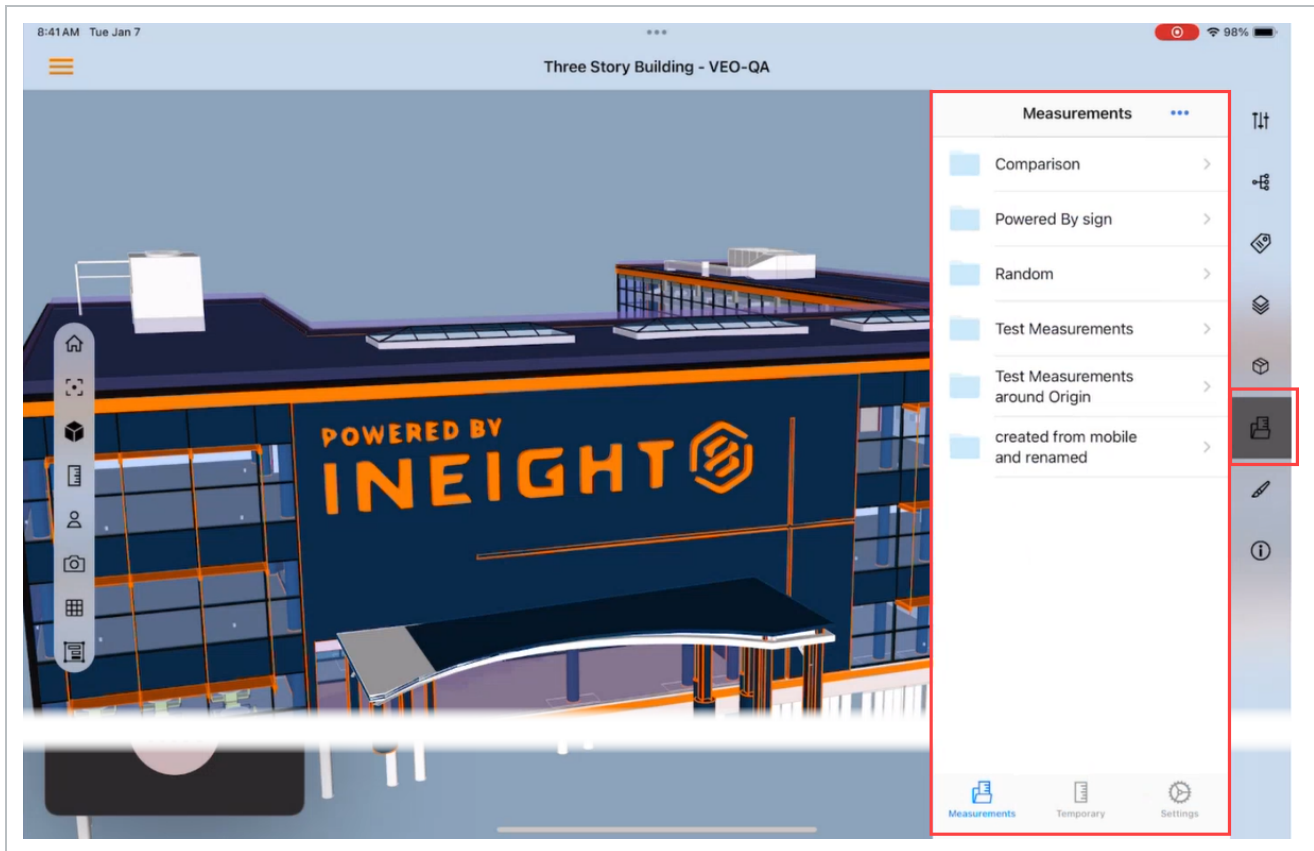

In the Measurements panel, you can access the Measurements, Temporary, and Settings tabs at the bottom of the menu.

- **Measurements**

In the Measurements panel you can save and organize your measurements in default and

custom folders.

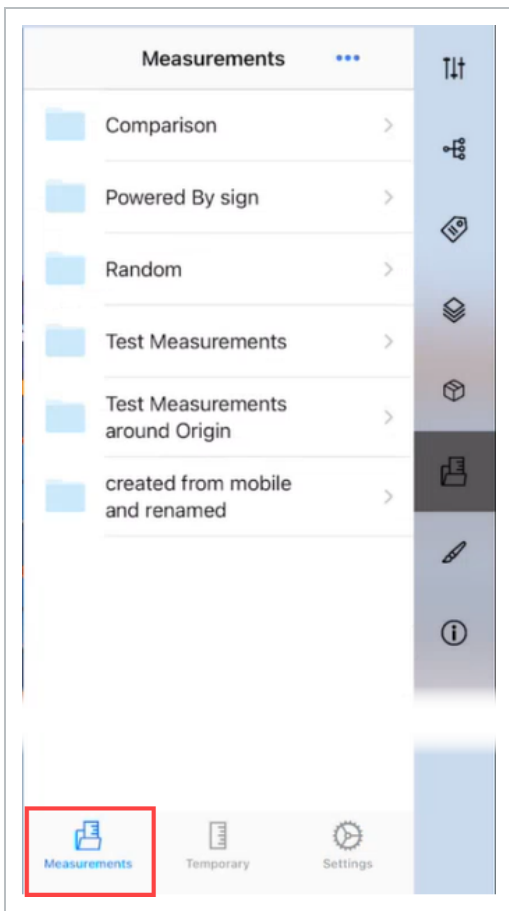

- **Temporary**

The Temporary panel captures your current active measurement being performed.

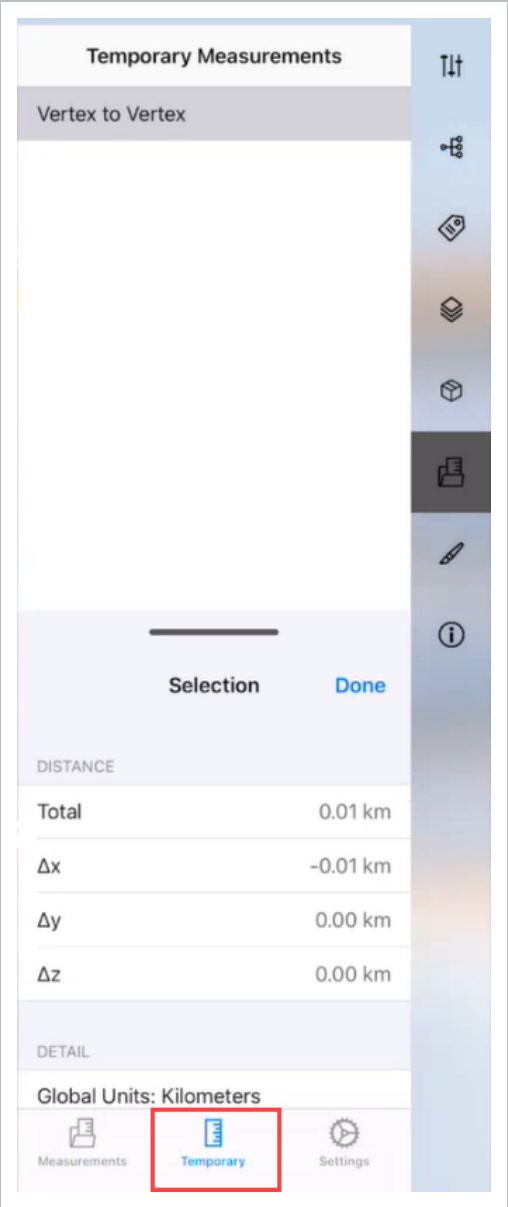

- **Settings**

The Settings panel lets you manage the settings for your measurement.

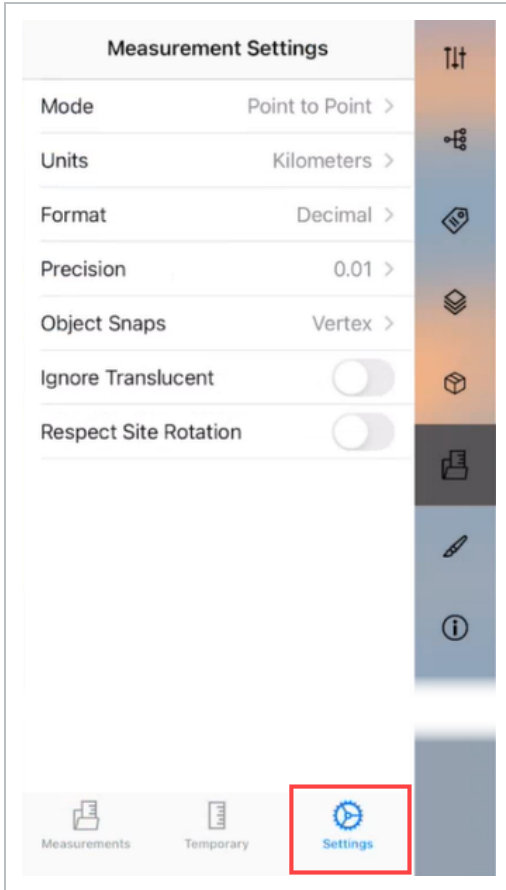

You can manage the mode, units, format, precision, and object snaps of your measurement.

[Read more](#)

Setting	Description
<p>Mode</p>	<p>You can select from different the following modes to take your measurements:</p> <ul style="list-style-type: none"> • Point to Point - Lets you use basic point A to point B measurement. • Continuous - Lets you continuously measure along a series of chosen points. Double-click on the last point to end the continuous measurement. • Area - Select a series of points that define an enclosed area. Close the area measurement by clicking on Point A. Points picked must be on the same plane. • Angle - Lets you pick three points to find an angle.

Setting	Description
	<ul style="list-style-type: none"> • Spot ID - Select a point to show the X, Y, Z coordinates of the point. Spot IDs can be copied to clipboard.
Units	You can select a unit to be shown when taking a measurement. Units are constrained according to the type of mode that is selected. The units are denoted in italics and cannot be unselected.
Format	You can select a format to show when taking a measurement. Formats are constrained according to the type of mode that is selected. The formats are denoted in italics and cannot be unselected.
Precision	You can select the best precision for your measurement.
Object Snaps	<p>You can select one or multiple object snaps to define the selection type of taking a measurement. Face and Object are exclusive snaps and cannot be active at the same time.</p> <ul style="list-style-type: none"> • Vertex - Snap to any corner or endpoint. • Center - Snap to the center of a face. • Face - Snap to any face. The measurement is calculated according to the closest point between the face selected and the other objects involved in the measurement. • Object - Snap to any object. The measurement is calculated according to the closest point between the object selected and the other objects involved in the measurement.
Ignore Translucent	When enabled, translucent objects in the view window are ignored, letting you indicate whether translucent objects, such as room, operation, or maintenance volumes are included in the model project. Measurements do not consider translucent objects.
Respect Site Rotation	When enabled, measurement calculations are defined according to the site rotation values defined on Model stream import.

14.1.1 STEPS

PERFORM A MEASUREMENT

1. Click the **Measurement** icon on the left ribbon to enter measurement mode.

When in measurement mode, the Cancel and Done buttons show at the top of the screen and the current measurement configuration shows at the bottom of the screen.

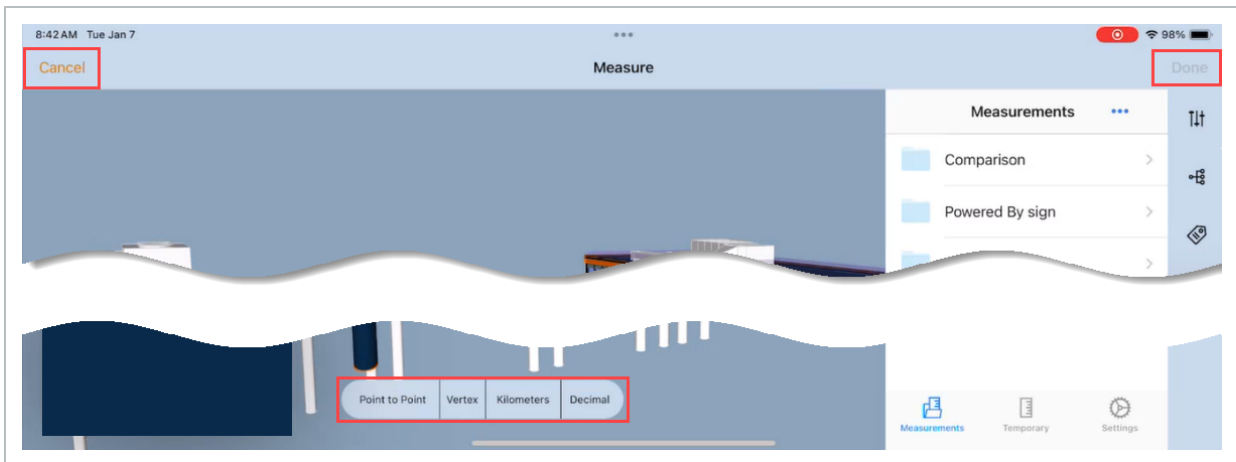

2. Perform your measurement, and then click **Done**.

The measurement is shown in the Temporary tab in the Measurements panel.

3. Click **Done** to save the measurement.

14.2 ELEMENTS

14.3 QUANTITY CLAIMING

You can perform claiming in the Elements panel's Claiming tab and sync with InEight Plan. You can mark the completion of claiming schemes in full or enter a partial install quantity.

The following image shows claiming in the Elements panel:

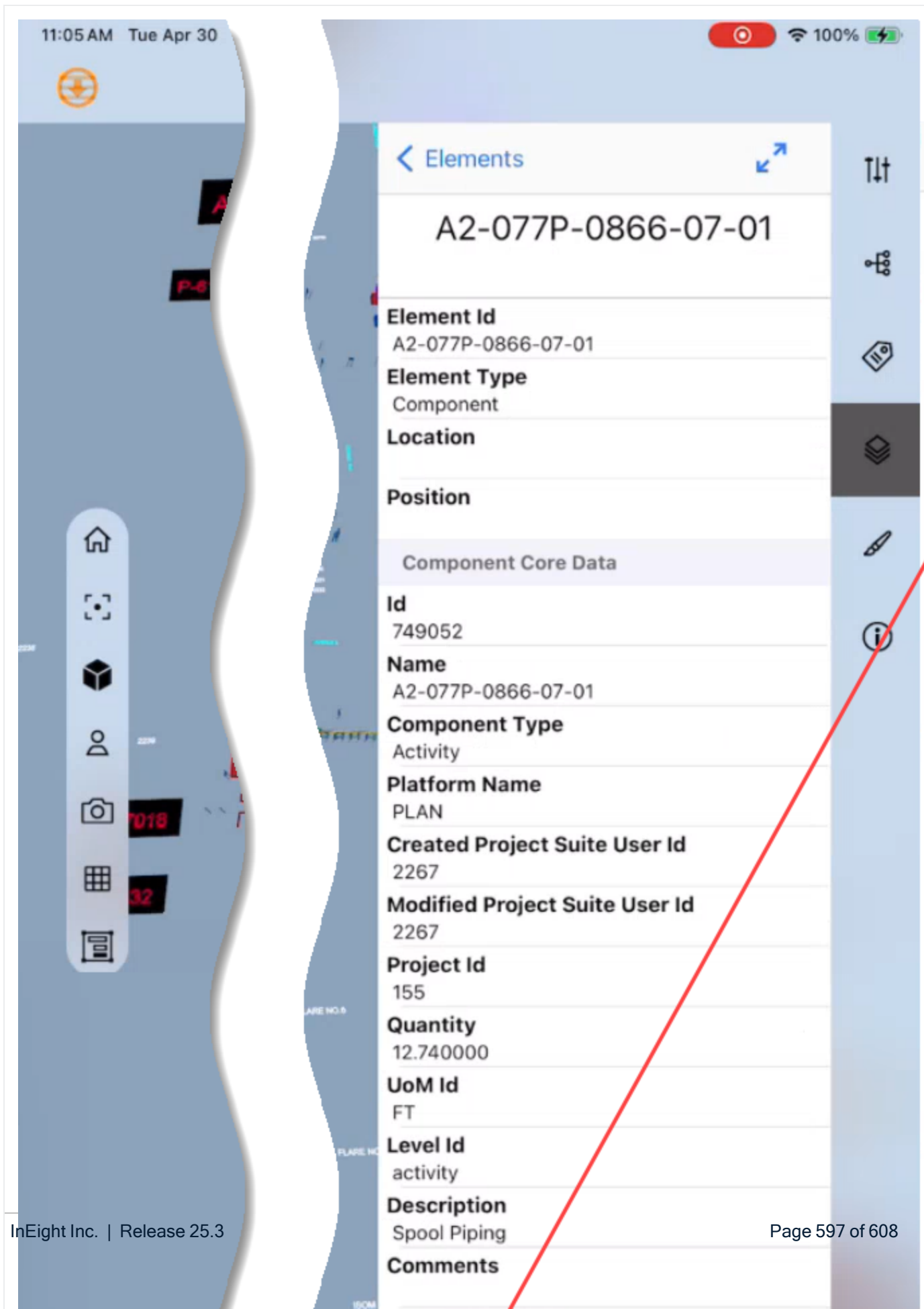

14.3.1 STEPS

- **Complete quantity claiming** – Select a component in the Elements panel, click the **Components claiming** icon, and then select the **Edit component** icon. Mark the claiming item's checkbox to do complete claiming.

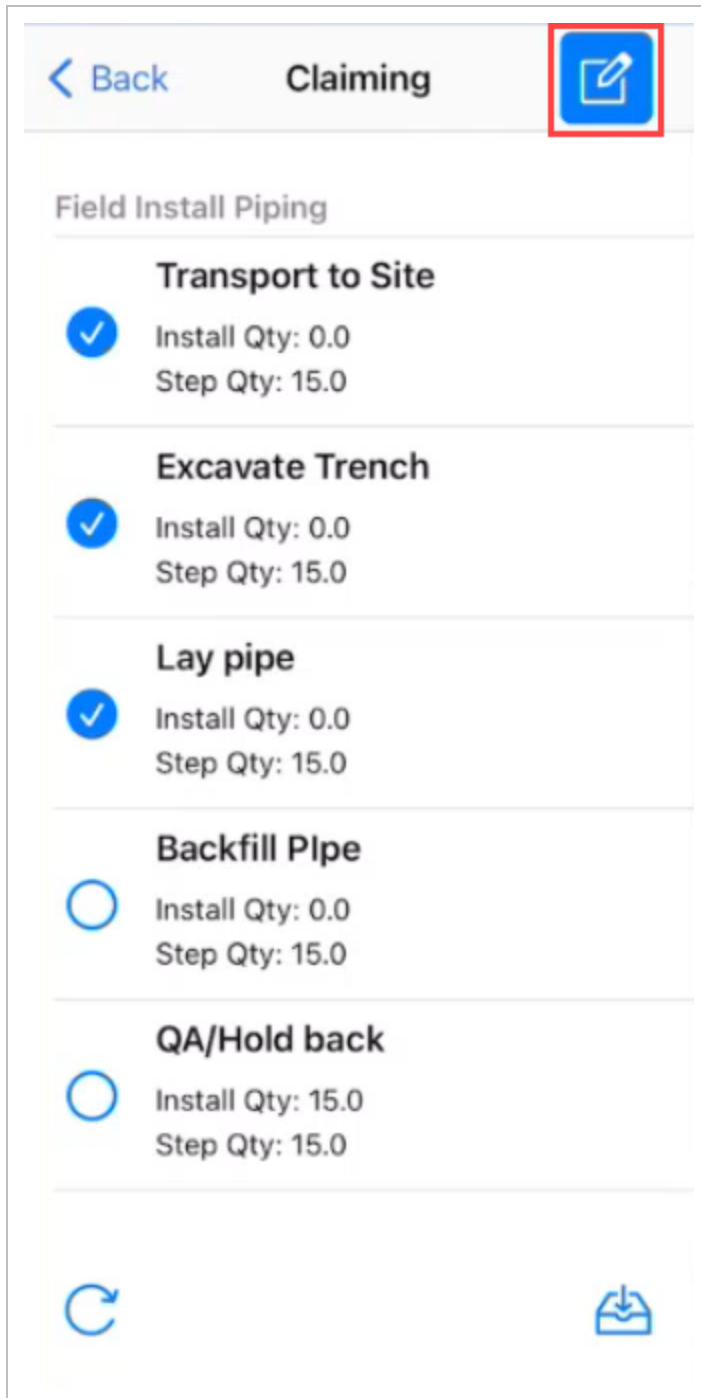

- **Partial and complete quantity claiming** – To do partial claiming, select a component in the Elements panel, click the **Components claiming** icon, and then select the **Edit component** icon. Tap on an item, tap **Install Quantity**, enter a quantity, and then click **Ok**.

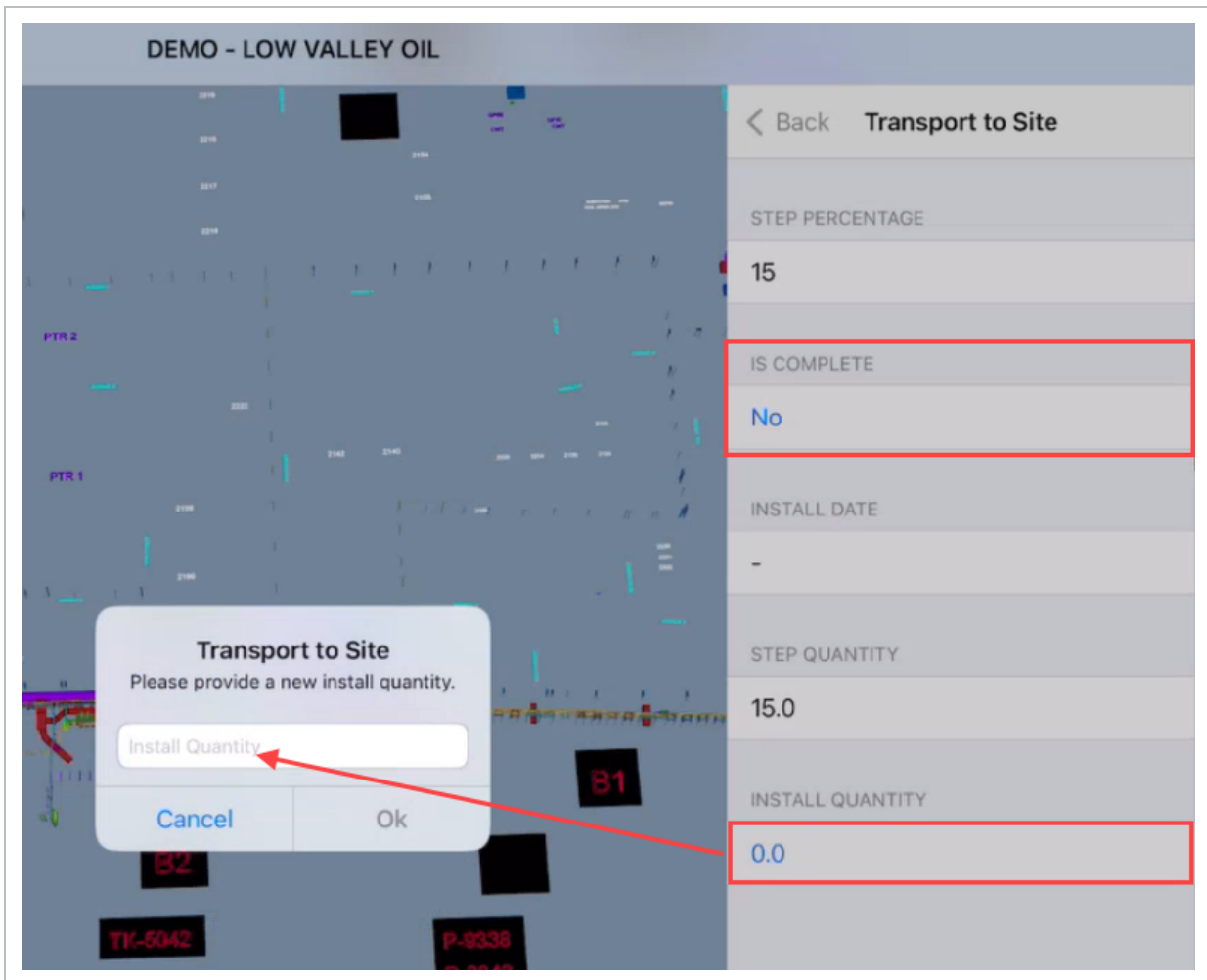

You can also do full claiming, by select **Yes** in the **Is Complete** field.

When you do claim updates, the updates save to your Project Updates queue. When you sync, updates for claiming sync with Plan. You must perform a sync operation to sync your updates to Plan.

14.3.2 CONSIDERATIONS

Reverse claiming must be done in the Plan application. After you reverse claiming quantities in Plan, changes will sync in Model.



14.4 ADVANCED WORK PACKAGING & WORKFACE PLANNING

14.5 QUANTITY CLAIMING

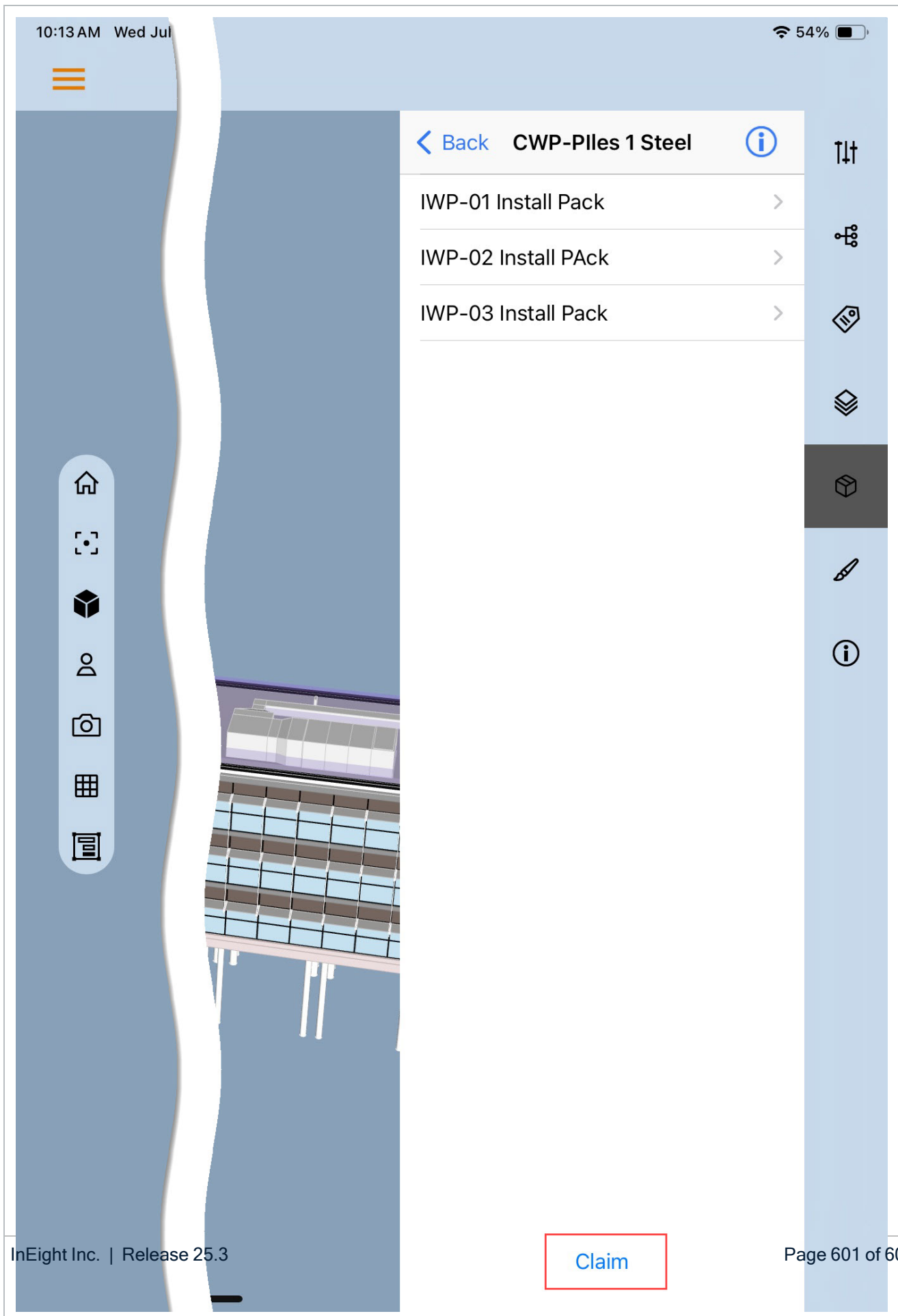
You can perform claiming in the AWP panel's Claiming tab, and then sync with InEight Plan. You can mark the completion of claiming schemes in full or enter a partial install quantity.



You can perform bulk and individual claiming at the CWP and IWP level by tapping the **Claim** icon.

<p>← Back CWP-Piles 1 Steel </p> <p>IWP-01 Install Pack ></p> <p>IWP-02 Install PAck ></p> <p>IWP-03 Install Pack ></p> <p>Claim</p>	<p>← IWP-01 Install Pack  </p> <p>Pile-Steel Pipe:400mm Dia...</p> <hr/> <p>Element Id Pile-Steel Pipe:400mm Diameter:148644</p> <p>Element Type Component</p> <p>Location</p> <hr/> <p>Position Foundation Work / Pile-Steel Pipe:400mm Diameter:148644</p> <p>Component Core Data</p> <p>Id 1904</p> <p>Name Pile-Steel Pipe:400mm Diameter:148644</p> <p>Component Type Activity</p> <p>Platform Name PLAN</p> <p>Created Project Suite User Id 190</p> <p>Modified Project Suite User Id 190</p> <p>Project Id 9</p> <p>Quantity 1.000000</p> <p>UoM Id Each</p> <p>Level Id activity</p> <p>Description</p> <p>Comments</p>
---	--

You can also perform partial and full claiming by tapping individual steps and entering the install quantity or select **Yes** in the Is **Complete** field.

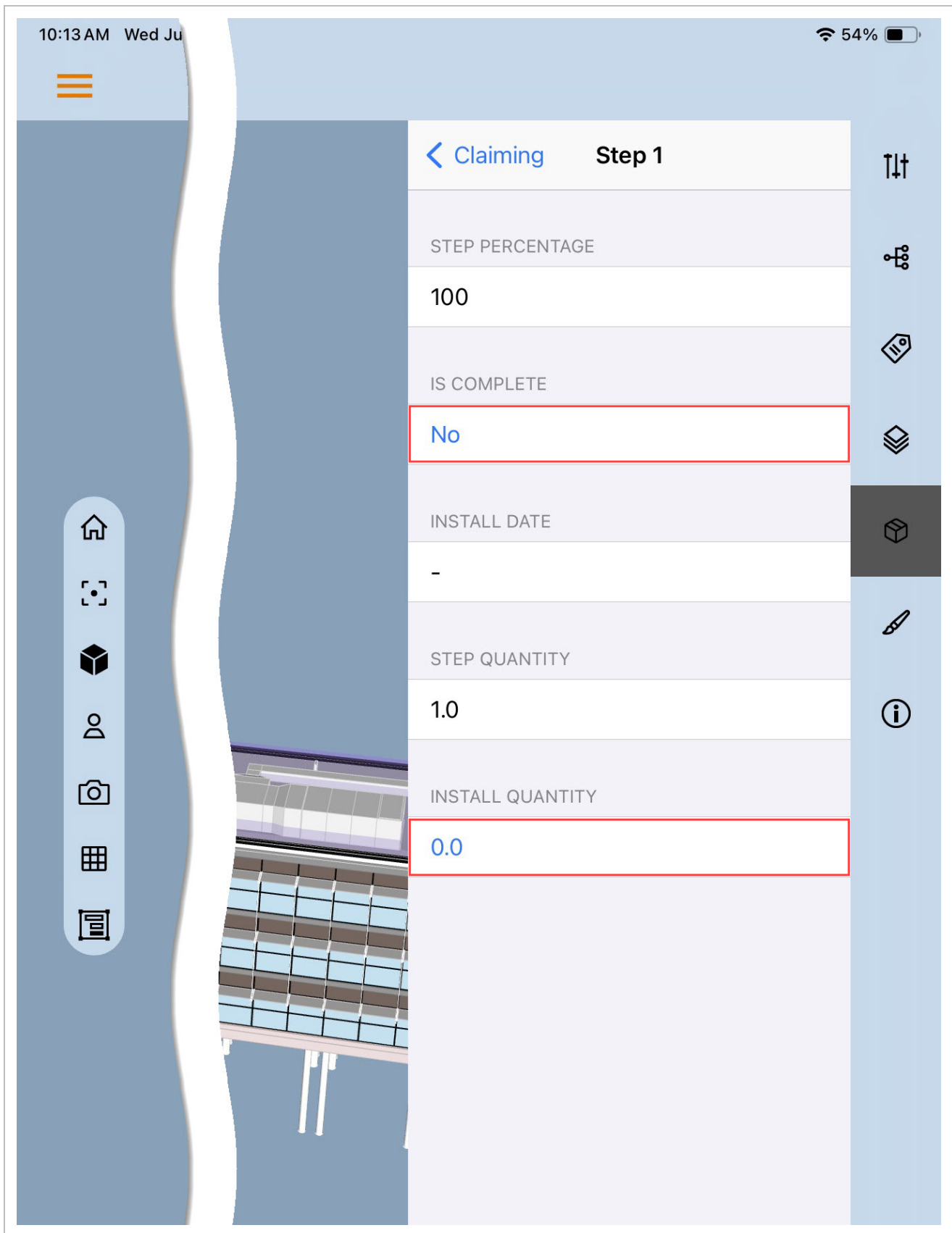

When you perform claim updates, the updates are saved to your Project Updates queue, and then when you perform a sync operation, the updates for claiming sync with Plan. You must perform a sync operation to sync your updates to Plan.

14.5.1 CONSIDERATIONS

Reverse claiming must be done in the Plan application. After you reverse claiming quantities in Plan, changes will sync in Model.

14.6 MODEL FREQUENTLY ASKED QUESTIONS

What file formats does the software support for import and export?

Users can import model content from a variety of authoring tools using plug-ins or through IFC import. Each model imported is considered a model stream. The plug-ins listed below are installed and updated with the InEight Model application.

- **Revit plugin (Windows)** - The Revit plugin allows exporting models from Revit into Model.
- **AutoCAD plugin (Windows)** - The AutoCAD plugin provides a means for exporting models from AutoCAD into Model.
- **Navisworks plugin (Windows)** - The Navisworks plugin provides a means for exporting models from Navisworks into Model.
- **IFC import (Windows):** The IFC import provides a means for importing IFC (Industry Foundation Class) type files into the Model.

What are the hardware requirements for Model Desktop?

These are the recommended minimum system requirements for InEight Model:

CPU: Quad-Core Processor w/ 3.0 GHz (x64)

Storage: 50 GB hard disk space¹

Memory: 32 GB RAM ¹

Display: 1920x1080 32-Bit Color

Graphics Dedicated graphics: (NVIDIA or AMD) 8 GB VRAM or better

Software: Windows 10 Professional or Enterprise (64-bit), .NET Framework 4.7 or 4.8 ²

Internet/ Network: Broadband internet connection 1Mbps

Browser: Google Chrome (latest GA version and prior two releases, N-2)

NOTE

Configure your PC to provide the best performance by setting the Preferred Graphics Processor to High-Performance NVIDIA Processor.

1 – Additional RAM, and/or hard disk space might be required based on load and amount of data.

2 – .NET 4.7 Requires Windows 10 Professional/Enterprise w/ Anniversary Update or newer.

3 – InEight software is officially supported only on Google Chrome. While the software might function on other browsers such as Microsoft Edge, full compatibility or optimal performance cannot be guaranteed. If you encounter any issues while using a browser other than Google Chrome, note that InEight will not provide support or service tickets for those issues. For the best experience and support, using Google Chrome is strongly recommended.

What are the hardware requirements for Model Mobile?

An Apple iPad device matching the following minimum requirements:

- M1, or M2 Chip
- 6-core CPU with 2 performance and 4 efficiency cores
- 4-Core GPU
- 16-core Neural Engine
- 256 GB capacity
- 8 GB RAM
- WiFi 6 (802.11a/b/g/n/ac/ax)
- 2.4GHz and 5GHz
- Simultaneous dual band
- Speeds up to 1.2 Gbps
- Cellular connection is optional

Does the software support point clouds and lidar data?

Information on importing, visualizing, and using point cloud data within the software and knowledge library.

Can I collaborate on projects with others using this software?

InEight Model is a platform for model and information aggregation that hides the complexity of managing versions and sharing information across teams. In addition, InEight Model offers collaboration to software outside of the platform as well.

Are there resources or tutorials available to help get me started?

Yes, see our [E-Learning courses](#), [Knowledge Library Topics](#) and [Videos](#).
